



*Price List*  
*EU-UK*  
*2024*

**AKABA**





*furniture with personality  
to work well and live better*

**AKABA**



---

<b>TERMS &amp; CONDITIONS</b>	p. 06
<b>UPHOLSTERY AND TABLE TOPS</b>	p. 08
<b>SYMBOLS AND ABBREVIATIONS</b>	p. 09
<b>PRODUCT INDEX</b>	p. 10
<b>ALPHABETICAL INDEX</b>	p. 16
<b>PRICE LIST</b>	p. 17
<b>LIBRARY OF MATERIALS</b>	p. 180

---

---

# TERMS & CONDITIONS

All commercial relationship between AKABA S.A. and their clients shall be governed by the following terms & conditions of sale, which shall be understood as accepted by the buyer by the mere fact of placing an order:

This price list becomes to effective on 1 April 2023, cancelling the previous price list and remaining in force until the publication of a new price list. All public prices do not include VAT.

## GENERAL CONDITIONS:

- Production lead time: 4-6 weeks for chairs and 6-8 weeks for desk systems and tables (excluding holidays and factory closing days).
- The type of transport included in this price list is consolidated. It includes transport to a warehouse at a ground level unloading point with easy access for trailers. Orders will be delivered within business hours without a fixed delivery day. The estimated transit for this type of shipments is 8-10 business days. AKABA cannot ensure deliveries in a shorter time than the one stipulated in this price list.
- Unloading and handling of the goods shall be at the expense of the receiver.
- The disposal and recycling of packaging shall be at the buyer's expense and is the buyer's responsibility.

## COUNTRY SPECIFIC CONDITIONS:

- ITALY/AUSTRIA/GERMANY/DENMARK: transport in DAP conditions and packaging in any of these countries is included for orders over 3.000 € net. For orders less than 3.000 € net, a fee of 150 € will be charged for transportation.
- SWITZERLAND: transport in DAP conditions and packaging in any of these countries is included for orders over 2.000 € net. For orders less than 3.000 € net, a fee of 180 € will be charged for transportation.
- UK/IRELAND: transport in DAP conditions. Transport and packaging are included for the UK mainland for England, Wales & Southern Scotland for orders over 3.000 €. For orders less than 3.000 €, a fee of 150 € will be charged for transportation. Extra fees may apply for Northern Scotland, Northern Ireland and non-UK mainland deliveries.

## ACCEPTANCE AND ORDER CONFIRMATION

The commitment of sales and delivery will not be firm until acceptance by means of an order confirmation sent on official AKABA document. If AKABA S.A. does not receive the conformity within a period of 3 working days, the confirmation will be the valid document. Any change after this period could imply a supplement that will be charged to the customer.

AKABA S.A. retains the right to introduce modifications or improvements for technical for technical or aesthetic reasons.

## ORDER MODIFICATION OR CANCELLATIONS

Order cancellations require previous approval where non-recuperable expenses by AKABA, S.A. will be evaluated and charged.

## PAYMENT TERMS

Payment will be fulfilled as per the terms included on the order confirmation. Orders are invoiced on the dispatch date that appears on the order confirmation. Factory pick-up orders are also billed on the date indicated in the confirmation.

## GUARANTEE

AKABA S.A. guarantees its products during 5 years against any manufacturing defect excluding under this concept any damage occurring due to incorrect use, negligence, natural wear of the product and of the material sent by the client.

---

## **TRANSPORT CLAIMS**

Any claim about flaws or damages caused during transport must be communicated within 48 hours of delivery and leaving a "NON CONFORMITY" message on the carrier's delivery note. Material control is recommended upon receipt of the merchandise.

Outside of this period, AKABA S.A. will not be responsible for any transportation claim. AKABA S.A. will not accept damage claims caused by transport for goods that are no longer in the delivery warehouse designated in the order confirmation.

## **JURISDICTION**

For any litigious or legal cases that may arise, the parties will be subject to the jurisdiction of the Courts of San Sebastián-Donostia, Spain.

## **CERTIFICATES AND AWARD**

- ISO 9001
- ISO 14001
- ISO 14006
- National Design Award 2000
- Premio Príncipe Felipe a la Excelencia Empresarial 2002

---

# UPHOLSTERY AND TABLE TOPS

## AVAILABLE UPHOLSTERY

---

GROUP D	GROUP C	GROUP B	GROUP A	SOFT LEATHER
Basic FR by EXIT	Citadel by CAMIRA Gravity by CAMIRA Medley by GABRIEL Tonal by GABRIEL	Ascot by ELASTRON Cyber by GABRIEL Go Uni by GABRIEL Main Line Flax by CAMIRA Step Melange by GABRIEL Valencia by SPRADLING	Blazer by CAMIRA Breeze Fusion by GABRIEL Crisp by GABRIEL Focus by GABRIEL Grain by GABRIEL Remix3 by KVADRAT	Serie 100 by ANTIC CUIR

---

Colours out from standard fabric samples or soft leather sample cards, will have a 45 € net price increase per order.

## COF/COL

---

AKABA S.A. may require a previous sample in order to approve non standard fabric or Soft leather. AKABA S.A. cannot guarantee optimal upholstery with these fabrics or soft leathers. AKABA S.A. does not guarantee optimal upholstery with fabrics/leathers outside the collection and reserves the right to reject fabrics / leathers if they are not appropriate.

All materials supplied by the client will be sent postage paid. Any additional cost caused by the customer's material will be charged to the invoice.

AKABA S.A. is not responsible to any client or third party for claims or damages in relation to products upholstered with COF/COL materials

The footage calculated in the rate is for 140cm wide fabrics. For projects, consult the factory for possible uses and improvements of footage.

## OFF-COLOUR

---

Certain clothing and accessory dyes (such as those used on denim jeans) may migrate to lighter colours. This phenomenon is increased by humidity and temperature and is irreversible. AKABA S.A. will not assume responsibility for dye transfer caused by external contaminants and possible permanent staining caused by this phenomenon.

## WOOD TABLE TOPS

---

AKABA S.A. will not be responsible for the total uniformity and similarity in the tables that have more than one table top. The nature of this finish, its diversity of veins, tones and shades from one sheet to another, mean that exact uniformity cannot be guaranteed.

---

# GLOSSARY OF SYMBOLS AND ABBREVIATIONS

## SYMBOLS

---



XX Product weight in kg



XX First product weight without upholstery  
XX Second product weight with upholstered seat



XX First product weight without upholstery  
XX Second product weight with upholstered seat  
XX Third product weight with upholstered seat/back



XX First product weight without upholstery  
XX Second product weight with upholstered seat  
XX Third product weight with upholstered front  
XX Fourth product weight fully upholstered



Box dimension



Units per box



Number of stacking chair on the floor



Wood grain orientation



Expedition in 5 working days

## ABBREVIATIONS

---

B Base size

C Column diameter

E Table tops size

DP Distance between legs

DPT Workplace distance

COF Customer own fabric

COL Customer own leather

# PRODUCT INDEX

## *Aia*

Isaac Piñeiro



4 LEGS  
p. 18



4 LEGS  
p. 18



LOUNGE  
p. 19

## *Hodei*

Muka Design Lab

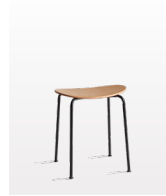

HEIGHT 450mm  
p. 21



HEIGHT 640mm  
p. 21



HEIGHT 760mm  
p. 21

## *Lur*

Pensi Design Studio



4 LEGS  
p. 24



SLED  
p. 25



PYRAMID TUBE  
p. 26



PYRAMID FIXED  
p. 27



PYRAMID FIXED  
p. 27



PYRAMID SWIVEL  
p. 28



PYRAMID SWIVEL  
p. 28



4 LEGS WOOD  
p. 29



4 LEGS WITH  
p. 30



OFFICE  
p. 31

## *Klasik*

Gabriel Teixidó



4 LEGS  
p. 33



SLED  
p. 34



WOOD LEGS  
p. 35



SWIVEL  
p. 36



SWIVEL  
p. 37



# Kabi

Pensi Design Studio



4 LEGS  
p. 39



4 LEGS  
p. 39



4 LEGS  
p. 39



4 LEGS  
p. 39



4 LEGS  
p. 39



NON-STACKABLE  
p. 41



WOOD LEGS  
p. 42



SLED  
p. 43



HIGH CHAIR  
p. 45



PYRAMID  
p. 46



PYRAMID  
p. 46



SWIVEL  
p. 47



SWIVEL  
p. 47



OFFICE  
p. 48



OFFICE  
p. 48



OFFICE HIGH CHAIR  
p. 49



OFFICE WITH DESK TRAY  
p. 50

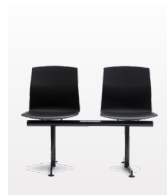

BEAM  
p. 51

# Kabi Kids

Pensi Design Studio



4 LEGS  
p. 54



4 LEGS  
p. 56



SLED  
p. 57



PYRAMID  
p. 58



WOOD LEGS  
p. 59

# Kabi Stool

Pensi Design Studio

# Kabi Armchair

Pensi Design Studio



4 LEGS  
p. 61



WOOD LEGS  
p. 61



SLED  
p. 61



SWIVEL  
p. 62



SWIVEL  
p. 62



OFFICE  
p. 62

# Gorka

Pensi Design Studio

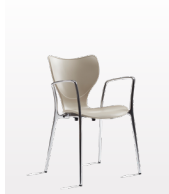

POLYAMIDE  
p. 64



WOOD  
p. 66



XL WOOD  
p. 68



XL SWIVEL  
p. 69

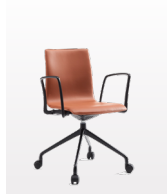

XL SWIVEL  
p. 69



LOUNGE WIRE  
p. 70

# Ados

Miguel Angel Ciganda



WITHOUT ARMS  
p. 77



WITH ARMS  
p. 77

# Branka

Pensi Design Studio



POLYPROPYLENE  
p. 72



UPHOLSTERED  
p. 72



WOOD  
p. 74

# Muga & Muga-2

Pensi Design Studio

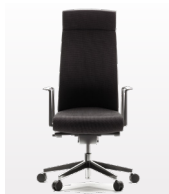

HIGH ADJUSTABLE  
p. 80



MEDIUM ADJUSTABLE  
p. 80



FIXED HIGH  
p. 80



FIXED MEDIUM  
p. 80



MUGA-2  
p. 82

# Hanna

Francesc Rifé



4 LEGS  
p. 84



4 LEGS  
p. 84



SLED  
p. 85



SLED  
p. 85



SLED LOUNGE  
p. 86



SLED LOUNGE  
p. 86



CANTILEVERED  
p. 87



CANTILEVERED  
p. 87



CANTILEVERED LOUNGE  
p. 88



CANTILEVERED LOUNGE  
p. 88



SWIVEL  
p. 89



SWIVEL  
p. 89



SWIVEL  
p. 90



SWIVEL  
p. 90



OFFICE  
p. 91



OFFICE  
p. 91



WOOD  
p. 92

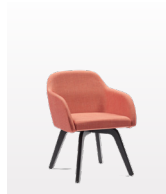

WOOD  
p. 92



WOOD LOUNGE  
p. 93



WOOD LOUNGE  
p. 93



TABLE  
p. 94

# Xoko & Gune

Iratzoki Lizaso

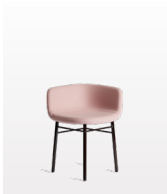

HEIGHT 460mm  
p. 96

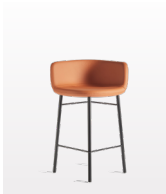

HEIGHT 670mm  
p. 96



HEIGHT 780mm  
p. 96



COLLABORATIVE  
p. 97



CENTRAL COLUMN  
p. 98



CENTRAL COLUMN  
p. 98



CENTRAL COLUMN  
p. 99



CENTRAL COLUMN  
p. 99



CENTRAL COLUMN  
p. 99



SEPARATE COLUMN  
p. 100

# Ostoa

Ander Lizaso



POUF S  
p. 103



POUF M  
p. 103



POUF L  
p. 103



CENTRAL COLUMN  
p. 104



CENTRAL COLUMN  
p. 104



DOUBLE COLUMN  
p. 104



DOUBLE COLUMN  
p. 104



ARMCHAIR GLIDES  
p. 105



ARMCHAIR CASTORS  
p. 105

# Topa

Pensi Design Studio



POUF  
p. 107



POUF  
p. 107



TABLE  
p. 108



SEAT  
p. 109



SOFA  
p. 109



SOFA  
p. 109



SIDE TABLE  
p. 110



CONSOLE TABLE  
p. 110



COMPOSITIONS  
p. 110



COMPOSITIONS  
p. 110



COMPOSITIONS  
p. 110

# Tknika

Francesc Rifé



CONTRACT  
p. 113



COLLABORATIVE  
p. 119



OFFICE BENCH  
p. 121



DIVERSE  
p. 123

# Usoa

Tabuena & Leache Arquitectos



WORKSTATION  
p. 130



COMPASS LEG  
p. 132



BALANCE LEG  
p. 134



ROUND  
p. 138



SQUARE  
p. 138

# Aski

# Carma & Carma Folding

Pensi Design Studio



ROUND  
p. 145



LEG 180°  
p. 146



ANGLE LEG  
p. 147



FOLDING  
p. 152

# Bat Office & Executive

Francesc Rifé



WORKSTATION  
p. 158



BENCH  
p. 163



SPINE  
p. 167



WORK DES  
p. 171

# Zubi



CONFIGURATIONS  
p. 177

---

## ALPHABETICAL INDEX

<b>ADOS</b>	p. 76	<b>KABI KIDS</b>	p. 53
<b>AIA</b>	p. 17	<b>KABI STOOL</b>	p. 55
<b>ASKI</b>	p. 136	<b>KLASIK</b>	p. 32
<b>BAT EXECUTIVE</b>	p. 168	<b>LUR</b>	p. 23
<b>BAT OFFICE</b>	p. 154	<b>MUGA &amp; MUGA-2</b>	p. 79
<b>BRANKA</b>	p. 71	<b>OSTOA</b>	p. 102
<b>CARMA &amp; CARMA FOLDING</b>	p. 142	<b>TKNIKA</b>	p. 111
<b>GORKA</b>	p. 63	<b>TOPA</b>	p. 106
<b>HANNA</b>	p. 83	<b>USOA</b>	p. 128
<b>HODEI</b>	p. 20	<b>XOKO &amp; GUNE</b>	p. 95
<b>KABI</b>	p. 38	<b>ZUBI</b>	p. 175
<b>KABI ARMCHAIR</b>	p. 60		

---

# Aia

Isaac Piñeiro



With smooth and clean curves, Aia is inspired by the Japanese sense of simplicity and harmony. Large surfaces of the finest wood and a line created by the tubular steel structure makes it visually very light.

Aia is a chair that fits anywhere in any space. Its pure lines and natural materials create a warm feeling. It is versatile and works in offices, hotels, restaurants and residential environments.



# Aia 4 Legs

Isaac Piñeiro

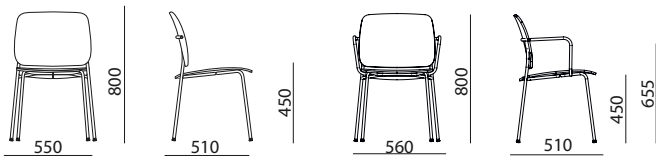

Chair without or with arms, steel tube of Ø16mm powder coated.

Seat and back in oak plywood natural varnished, option M-675 and M-676 with price increase. Seat upholstered or fully upholstered.

Polypropylene glides or felt glides with price increase.

 610x730x1080mm

 4 units (3 units upholstered)

## DRAWING

## SPECIFICATION

## REF.

## Euros

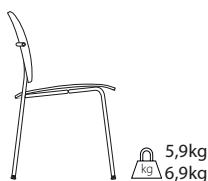

### Without Arms

<b>NON UPHOLSTERED</b> Oak M-670	<b>AI01/R</b>	323
<b>NON UPHOLSTERED</b> Oak M-675/M-676	<b>AI01/W</b>	365
<b>SEAT UPHOLSTERED</b> Group D	<b>AI01/D</b>	339
<b>SEAT UPHOLSTERED</b> Group C & COF	<b>AI01/C</b>	355
<b>SEAT UPHOLSTERED</b> Group B & Valencia	<b>AI01/B</b>	392
<b>SEAT UPHOLSTERED</b> Group A & COL	<b>AI01/A</b>	420
<b>SEAT UPHOLSTERED</b> Soft leather	<b>AI01/L</b>	442
<b>SEAT &amp; BACK UPHOLSTERED</b> Group D	<b>AI02/D</b>	374
<b>SEAT &amp; BACK UPHOLSTERED</b> Group C & COF	<b>AI02/C</b>	408
<b>SEAT &amp; BACK UPHOLSTERED</b> Group B & Valencia	<b>AI02/B</b>	463
<b>SEAT &amp; BACK UPHOLSTERED</b> Group A & COL	<b>AI02/A</b>	509
<b>SEAT &amp; BACK UPHOLSTERED</b> Soft leather	<b>AI02/L</b>	598
<b>WOOD BACK SUPPLEMENT M-675/M-676</b>		26

<b>AI01/R</b>	323
<b>AI01/W</b>	365
<b>AI01/D</b>	339
<b>AI01/C</b>	355
<b>AI01/B</b>	392
<b>AI01/A</b>	420
<b>AI01/L</b>	442
<b>AI02/D</b>	374
<b>AI02/C</b>	408
<b>AI02/B</b>	463
<b>AI02/A</b>	509
<b>AI02/L</b>	598
	26

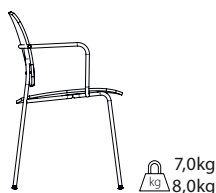

### With Arms

<b>NON UPHOLSTERED</b> Oak M-670	<b>AI03/R</b>	355
<b>NON UPHOLSTERED</b> Oak M-675/M-676	<b>AI03/W</b>	397
<b>SEAT UPHOLSTERED</b> Group D	<b>AI03/D</b>	371
<b>SEAT UPHOLSTERED</b> Group C & COF	<b>AI03/C</b>	385
<b>SEAT UPHOLSTERED</b> Group B & Valencia	<b>AI03/B</b>	424
<b>SEAT UPHOLSTERED</b> Group A & COL	<b>AI03/A</b>	449
<b>SEAT UPHOLSTERED</b> Soft leather	<b>AI03/L</b>	472
<b>SEAT &amp; BACK UPHOLSTERED</b> Group D	<b>AI04/D</b>	401
<b>SEAT &amp; BACK UPHOLSTERED</b> Group C & COF	<b>AI04/C</b>	436
<b>SEAT &amp; BACK UPHOLSTERED</b> Group B & Valencia	<b>AI04/B</b>	491
<b>SEAT &amp; BACK UPHOLSTERED</b> Group A & COL	<b>AI04/A</b>	536
<b>SEAT &amp; BACK UPHOLSTERED</b> Soft leather	<b>AI04/L</b>	623
<b>WOOD BACK SUPPLEMENT M-675/M-676</b>		28

<b>AI03/R</b>	355
<b>AI03/W</b>	397
<b>AI03/D</b>	371
<b>AI03/C</b>	385
<b>AI03/B</b>	424
<b>AI03/A</b>	449
<b>AI03/L</b>	472
<b>AI04/D</b>	401
<b>AI04/C</b>	436
<b>AI04/B</b>	491
<b>AI04/A</b>	536
<b>AI04/L</b>	623
	28

ATTENTION THE FIRST PRICES ARE FOR THE BACK IN M-670.

Measure: Only seat 0,62ml/ 8 feet. Seat and back 0,82 ml/14 feet. For projects, please contact the factory.

## ACCESSORIES

## DRAWING

## SPECIFICATION

## REF.

## Euros



**PRICE INCREASE FOR FELT** (per chair)

**ACT1**

10



# Aia Lounge

Isaac Piñeiro

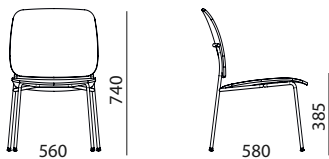

610x730x1080mm 3 units

Chair with or without arms, steel tube of Ø16mm powder coated.

Seat and back in oak plywood natural varnished, option M-675 and M-676 with price increase. Seat upholstered or fully upholstered.

Polypropylene glides or felt glides with price increase.

## DRAWING

## SPECIFICATION

## REF.

## €uros

### Aia Lounge

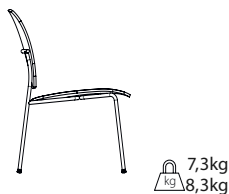

**NON UPHOLSTERED** Oak M-670

**AI05/R** 362

**NON UPHOLSTERED** Oak M-675/M-676

**AI05/W** 417

**SEAT UPHOLSTERED** Group D

**AI05D** 378

**SEAT UPHOLSTERED** Group C & COF

**AI05/C** 394

**SEAT UPHOLSTERED** Group B & Valencia

**AI05/B** 431

**SEAT UPHOLSTERED** Group A & COL

**AI05/A** 458

**SEAT UPHOLSTERED** Soft leather

**AI05/L** 479

**SEAT & BACK UPHOLSTERED** Group D

**AI06/D** 422

**SEAT & BACK UPHOLSTERED** Group C & COF

**AI06/C** 447

**SEAT & BACK UPHOLSTERED** Group B & Valencia

**AI06/B** 502

**SEAT & BACK UPHOLSTERED** Group A & COL

**AI06/A** 548

**SEAT & BACK UPHOLSTERED** Soft leather

**AI06/L** 635

**WOOD BACK SUPPLEMENT M-675/M-676**

35

**ATTENTION THE FIRST PRICES ARE FOR THE BACK IN M-670.**

Measure: Only seat 0,62ml/ 8 feet. Seat and back 0,82 ml/14 feet. For projects, please contact the factory.

## ACCESSORIES

## DRAWING

## SPECIFICATION

## REF.

## €uros



**PRICE INCREASE FOR FELT** (per chair)

**ACT1** 10

---

# Hodei

Muka Lab



Hodei is a family of stools with an eye-catching outline. Its oval, organic seat contrasts with its triangular metal structure to give it a strong personality.

This is a lightweight stool available in wooden and upholstered versions for combining with its structure in a thousand ways.

# Hodei

Muka Lab

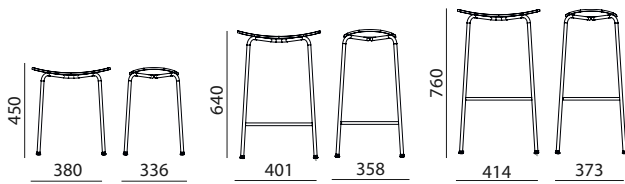

Height 450 mm	470x410x610mm	4 units
Height 640 mm	470x410x720mm	1 unit
Height 760 mm	470x410x820mm	1 unit

Stool available in 3 heights. 4 legs steel frame of Ø16mm powder coated.

Seat in plywood oak, available in 3 varnish colours or upholstered in fabric or soft leather.

Polypropylene glides, felt as an option with price increase.

## DRAWING

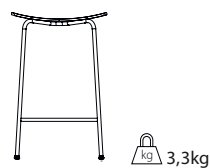

## SPECIFICATION

### Height 450mm

<b>NON UPHOLSTERED</b> Oak M-670
<b>NON UPHOLSTERED</b> Oak M-675/M-676
<b>FRONT UPHOLSTERED</b> Group D
<b>FRONT UPHOLSTERED</b> Group C & COF
<b>FRONT UPHOLSTERED</b> Group B & Valencia
<b>FRONT UPHOLSTERED</b> Group A & COL
<b>FRONT UPHOLSTERED</b> Soft leather
<b>FULLY UPHOLSTERED</b> Group D
<b>FULLY UPHOLSTERED</b> Group C & COF
<b>FULLY UPHOLSTERED</b> Group B & Valencia
<b>FULLY UPHOLSTERED</b> Group A & COL
<b>FULLY UPHOLSTERED</b> Soft leather

### Height 640mm

<b>NON UPHOLSTERED</b> Oak M-670
<b>NON UPHOLSTERED</b> Oak M-675/M-676
<b>FRONT UPHOLSTERED</b> Group D
<b>FRONT UPHOLSTERED</b> Group C & COF
<b>FRONT UPHOLSTERED</b> Group B & Valencia
<b>FRONT UPHOLSTERED</b> Group A & COL
<b>FRONT UPHOLSTERED</b> Soft leather
<b>FULLY UPHOLSTERED</b> Group D
<b>FULLY UPHOLSTERED</b> Group C & COF
<b>FULLY UPHOLSTERED</b> Group B & Valencia
<b>FULLY UPHOLSTERED</b> Group A & COL
<b>FULLY UPHOLSTERED</b> Soft leather

## REF.

## €uros

<b>HD01/M</b>	161
<b>HD01/W</b>	181
<b>HD04/D</b>	175
<b>HD04/C</b>	184
<b>HD04/B</b>	195
<b>HD04/A</b>	216
<b>HD04/L</b>	223
<b>HD01/D</b>	170
<b>HD01/C</b>	179
<b>HD01/B</b>	191
<b>HD01/A</b>	211
<b>HD01/L</b>	218
<b>HD02/M</b>	209
<b>HD02/W</b>	227
<b>HD05/D</b>	223
<b>HD05/C</b>	229
<b>HD05/B</b>	243
<b>HD05/A</b>	264
<b>HD05/L</b>	268
<b>HD02/D</b>	218
<b>HD02/C</b>	225
<b>HD02/B</b>	239
<b>HD02/A</b>	259
<b>HD02/L</b>	264

Measure: Fabric 0,33ml/ leather 6 feet. For projects, please contact the factory.

# Hodei

Muka Lab

DRAWING

SPECIFICATION

REF.

€uros

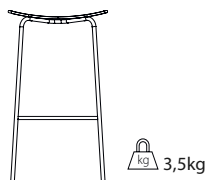

## Height 760mm

**NON UPHOLSTERED** Oak M-670

**HD03/M**

209

**NON UPHOLSTERED** Oak M-675/M-676

**HD03/W**

227

**FRONT UPHOLSTERED** Group D

**HD06/D**

223

**FRONT UPHOLSTERED** Group C & COF

**HD06/C**

229

**FRONT UPHOLSTERED** Group B & Valencia

**HD06/B**

243

**FRONT UPHOLSTERED** Group A & COL

**HD06/A**

264

**FRONT UPHOLSTERED** Soft leather

**HD06/L**

268

**FULLY UPHOLSTERED** Group D

**HD03/D**

218

**FULLY UPHOLSTERED** Group C & COF

**HD03/C**

225

**FULLY UPHOLSTERED** Group B & Valencia

**HD03/B**

239

**FULLY UPHOLSTERED** Group A & COL

**HD03/A**

259

**FULLY UPHOLSTERED** Soft leather

**HD03/L**

264

Measure: Fabric 0,33ml/ leather 6 feet. For projects, please contact the factory.

## ACCESSORIES

DRAWING

SPECIFICATION

REF.

€uros



**PRICE INCREASE FOR FELT** (per chair)

**ACT1**

10

---

# Lur

Pensi Design Studio



Lur is a family of chairs characterized by its enveloping design of round and organic outlines. The polypropylene one-shell seat, as comfortable as versatile, is available in a new colour range.

The programme offers infinite configuration options thanks to the variety of fabrics and the upholstery alternatives (frontal, partial or complete upholstery), as well as a wide selection of bases, which makes Lur an especially polyvalent collection.

A transversal and functional design, for all kinds of environments and markets.

# Lur 4 Legs

Pensi Design Studio

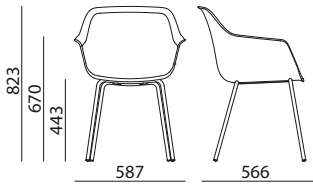

670X570X870 mm 1 unit

Chair with arms, powder coated Ø18mm steel tube structure. Chromed option with price increase. Seat-back-arms in one piece of polypropylene and fibreglass.

Supplementary upholstery only on seat, front upholstery or fully upholstered. Polypropylene glides, felt glides with price increase.

## DRAWING

## SPECIFICATION

## REF.

## €uros

### Lur 4 Legs

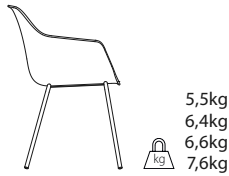

**NON UPHOLSTERED** Polypropylene

**LR01/P** 205

**SEAT UPHOLSTERED** Group D

**LR01/D** 268

**SEAT UPHOLSTERED** Group C & COF

**LR01/C** 276

**SEAT UPHOLSTERED** Group B & Valencia

**LR01/B** 295

**SEAT UPHOLSTERED** Group A & COL

**LR01/A** 321

**SEAT UPHOLSTERED** Soft leather

**LR01/L** 327

**FRONT UPHOLSTERED** Group D

**LR02/D** 460

**FRONT UPHOLSTERED** Group C & COF

**LR02/C** 477

**FRONT UPHOLSTERED** Group B & Valencia

**LR02/B** 508

**FRONT UPHOLSTERED** Group A

**LR02/A** 563

**FULLY UPHOLSTERED** Group D

**LR03/D** 463

**FULLY UPHOLSTERED** Group C & COF

**LR03/C** 507

**FULLY UPHOLSTERED** Group B & Valencia

**LR03/B** 576

**FULLY UPHOLSTERED** Group A & COL

**LR03/A** 676

**FULLY UPHOLSTERED** Soft leather

**LR03/L** 783

**CHROME SUPPLEMENT**

46

Measure: Only fabric seat 0,52ml/ 3 feet. Measure: Only fabric front 0,77ml. Measure: Fully upholstered 1,5ml/ 18 feet. For projects, please contact the factory.

## ACCESSORIES

## DRAWING

## SPECIFICATION

## REF.

## €uros



**PRICE INCREASE FOR FELT** (per chair)

**AC091** 10

# Lur Sled

Pensi Design Studio

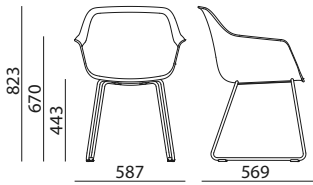

670X570X870 mm 1 unit

Chair with arms, powder coated Ø14mm steel tube structure. Chromed option with price increase. Seat-back-arms in one piece of polypropylene and fibreglass.

Supplementary upholstery only on seat, front upholstery or fully upholstered. Translucent glides included, felt glides with price increase.

## DRAWING

## SPECIFICATION

## REF.

## €uros

### Lur Sled

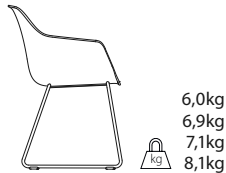

**NON UPHOLSTERED** Polypropylene

**LR04/P** 234

**SEAT UPHOLSTERED** Group D

**LR04/D** 298

**SEAT UPHOLSTERED** Group C & COF

**LR04/C** 306

**SEAT UPHOLSTERED** Group B & Valencia

**LR04/B** 325

**SEAT UPHOLSTERED** Group A & COL

**LR04/A** 351

**SEAT UPHOLSTERED** Soft leather

**LR04/L** 357

**FRONT UPHOLSTERED** Group D

**LR05/D** 489

**FRONT UPHOLSTERED** Group C & COF

**LR05/C** 507

**FRONT UPHOLSTERED** Group B & Valencia

**LR05/B** 538

**FRONT UPHOLSTERED** Group A

**LR05/A** 593

**FULLY UPHOLSTERED** Group D

**LR06/D** 493

**FULLY UPHOLSTERED** Group C & COF

**LR06/C** 537

**FULLY UPHOLSTERED** Group B & Valencia

**LR06/B** 606

**FULLY UPHOLSTERED** Group A & COL

**LR06/A** 707

**FULLY UPHOLSTERED** Soft leather

**LR06/L** 813

**CHROME SUPPLEMENT**

35

Measure: Only fabric seat 0,52ml/ 3 feet. Measure: Only fabric front 0,77ml. Measure: Fully upholstered 1,5ml/ 18 feet. For projects, please contact the factory.

## ACCESSORIES

## DRAWING

## SPECIFICATION

## REF.

## €uros



**PRICE INCREASE FOR FELT** (per chair)

**AC041** 13

# Lur Pyramid Tube

Pensi Design Studio

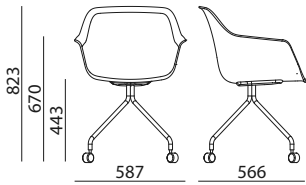

670X570X870 mm 1 unit

Chair with arms without swivel, with 4 arms base of powder coated Ø20mm steel tube with castors. Seat-back-arms in one piece of polypropylene and fibreglass.

Supplementary upholstery only on seat, front upholstery or fully upholstered. Option soft or hard castors.

## DRAWING

## SPECIFICATION

## REF.

## €uros

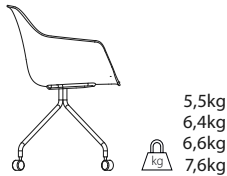

### Lur Pyramid Tube

**NON UPHOLSTERED** Polypropylene

**LR07/P** 276

**SEAT UPHOLSTERED** Group D

**LR07/D** 340

**SEAT UPHOLSTERED** Group C & COF

**LR07/C** 347

**SEAT UPHOLSTERED** Group B & Valencia

**LR07/B** 366

**SEAT UPHOLSTERED** Group A & COL

**LR07/A** 393

**SEAT UPHOLSTERED** Soft leather

**LR07/L** 399

**FRONT UPHOLSTERED** Group D

**LR08/D** 531

**FRONT UPHOLSTERED** Group C & COF

**LR08/C** 549

**FRONT UPHOLSTERED** Group B & Valencia

**LR08/B** 580

**FRONT UPHOLSTERED** Group A

**LR08/A** 635

**FULLY UPHOLSTERED** Group D

**LR09/D** 535

**FULLY UPHOLSTERED** Group C & COF

**LR09/C** 579

**FULLY UPHOLSTERED** Group B & Valencia

**LR09/B** 647

**FULLY UPHOLSTERED** Group A & COL

**LR09/A** 747

**FULLY UPHOLSTERED** Soft leather

**LR09/L** 854





**NOTE: SPECIFY SOFT CASTORS OR HARD CASTORS. IF THERE IS NO SPECIFICATION, HARD CASTORS WILL BE SENT.**  
Measure: Only fabric seat 0,52ml/ 3 feet. Measure: Only fabric front 0,77ml. Measure: Fully upholstered 1,5ml/ 18 feet.  
For projects, please contact the factory.

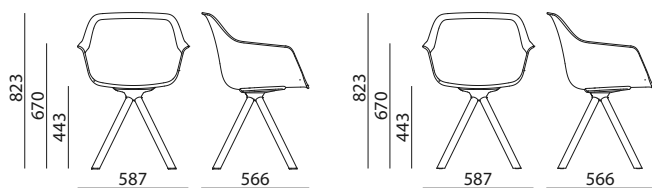

# Lur Pyramid Fixed

Pensi Design Studio



Aluminium Base  670X570X870 mm  1 unit  
 Wood Base  670X570X870 mm  1 unit

Chair with arms without swivel, with 4 arms base of powder coated aluminium or natural stained oak. Seat-back-arms in one piece of polypropylene and fibreglass.

Supplementary upholstery only on seat, front upholstery or fully upholstered. Translucent glides included, felt glides with price increase.

DRAWING

SPECIFICATION

REF.

€uros

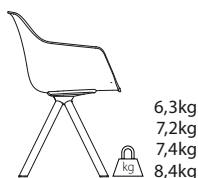

## Aluminium Base

**NON UPHOLSTERED** Polypropylene  
**SEAT UPHOLSTERED** Group D  
**SEAT UPHOLSTERED** Group C & COF  
**SEAT UPHOLSTERED** Group B & Valencia  
**SEAT UPHOLSTERED** Group A & COL  
**SEAT UPHOLSTERED** Soft leather  
**FRONT UPHOLSTERED** Group D  
**FRONT UPHOLSTERED** Group C & COF  
**FRONT UPHOLSTERED** Group B & Valencia  
**FRONT UPHOLSTERED** Group A  
**FULLY UPHOLSTERED** Group D  
**FULLY UPHOLSTERED** Group C & COF  
**FULLY UPHOLSTERED** Group B & Valencia  
**FULLY UPHOLSTERED** Group A & COL  
**FULLY UPHOLSTERED** Soft leather

LR10/P	286
LR10/D	350
LR10/C	357
LR10/B	376
LR10/A	402
LR10/L	408
LR11/D	541
LR11/C	559
LR11/B	590
LR11/A	645
LR12/D	544
LR12/C	588
LR12/B	658
LR12/A	758
LR12/L	864

## Wood Base

**NON UPHOLSTERED** Polypropylene  
**SEAT UPHOLSTERED** Group D  
**SEAT UPHOLSTERED** Group C & COF  
**SEAT UPHOLSTERED** Group B & Valencia  
**SEAT UPHOLSTERED** Group A & COL  
**SEAT UPHOLSTERED** Soft leather  
**FRONT UPHOLSTERED** Group D  
**FRONT UPHOLSTERED** Group C & COF  
**FRONT UPHOLSTERED** Group B & Valencia  
**FRONT UPHOLSTERED** Group A  
**FULLY UPHOLSTERED** Group D  
**FULLY UPHOLSTERED** Group C & COF  
**FULLY UPHOLSTERED** Group B & Valencia  
**FULLY UPHOLSTERED** Group A & COL  
**FULLY UPHOLSTERED** Soft leather

LR13/P	360
LR13/D	425
LR13/C	432
LR13/B	451
LR13/A	477
LR13/L	483
LR14/D	616
LR14/C	634
LR14/B	665
LR14/A	720
LR15/D	620
LR15/C	664
LR15/B	733
LR15/A	832
LR15/L	939

Measure: Only fabric seat 0,52ml/ 3 feet. Measure: Only fabric front 0,77ml. Measure: Fully upholstered 1,5ml/ 18 feet.  
 For projects, please contact the factory.

## ACCESSORIES

DRAWING

SPECIFICATION

REF.

€uros



PRICE INCREASE FOR FELT (per chair)





AC079

19

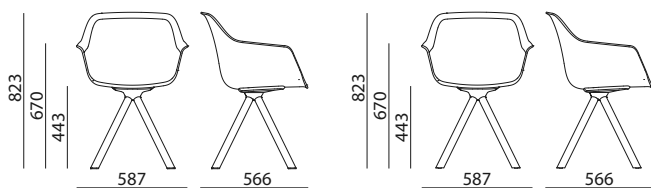
# Lur Pyramid Swivel

Pensi Design Studio



Aluminium Base  670X570X870 mm  1 unit  
 Wood Base  670X570X870 mm  1 unit

Chair with arms with swivel, with 4 arms base of powder coated aluminium or natural stained oak. Seat-back-arms in one piece of polypropylene and fibreglass.

Supplementary upholstery only on seat, front upholstery or fully upholstered. Translucent glides included, felt glides with price increase.

## DRAWING

## SPECIFICATION

## REF.

## €uros

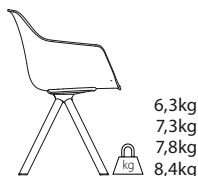

### Aluminium Base

**NON UPHOLSTERED** Polypropylene  
**SEAT UPHOLSTERED** Group D  
**SEAT UPHOLSTERED** Group C & COF  
**SEAT UPHOLSTERED** Group B & Valencia  
**SEAT UPHOLSTERED** Group A & COL  
**SEAT UPHOLSTERED** Soft leather  
**FRONT UPHOLSTERED** Group D  
**FRONT UPHOLSTERED** Group C & COF  
**FRONT UPHOLSTERED** Group B & Valencia  
**FRONT UPHOLSTERED** Group A  
**FULLY UPHOLSTERED** Group D  
**FULLY UPHOLSTERED** Group C & COF  
**FULLY UPHOLSTERED** Group B & Valencia  
**FULLY UPHOLSTERED** Group A & COL  
**FULLY UPHOLSTERED** Soft leather

LR16/P	348
LR16/D	412
LR16/C	420
LR16/B	438
LR16/A	464
LR16/L	471
LR17/D	604
LR17/C	621
LR17/B	653
LR17/A	708
LR18/D	608
LR18/C	652
LR18/B	720
LR18/A	820
LR18/L	926

### Wood Base

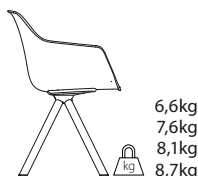

**NON UPHOLSTERED** Polypropylene  
**SEAT UPHOLSTERED** Group D  
**SEAT UPHOLSTERED** Group C & COF  
**SEAT UPHOLSTERED** Group B & Valencia  
**SEAT UPHOLSTERED** Group A & COL  
**SEAT UPHOLSTERED** Soft leather  
**FRONT UPHOLSTERED** Group D  
**FRONT UPHOLSTERED** Group C & COF  
**FRONT UPHOLSTERED** Group B & Valencia  
**FRONT UPHOLSTERED** Group A  
**FULLY UPHOLSTERED** Group D  
**FULLY UPHOLSTERED** Group C & COF  
**FULLY UPHOLSTERED** Group B & Valencia  
**FULLY UPHOLSTERED** Group A & COL  
**FULLY UPHOLSTERED** Soft leather

LR19/P	422
LR19/D	487
LR19/C	494
LR19/B	513
LR19/A	540
LR19/L	546
LR20/D	679
LR20/C	696
LR20/B	727
LR20/A	783
LR21/D	683
LR21/C	726
LR21/B	795
LR21/A	895
LR21/L	1.001

Measure: Only fabric seat 0,52ml/ 3 feet. Measure: Only fabric front 0,77ml. Measure: Fully upholstered 1,5ml/ 18 feet.  
 For projects, please contact the factory.

## ACCESSORIES

## DRAWING

## SPECIFICATION

## REF.

## €uros



**PRICE INCREASE FOR FELT** (per chair)

AC079

19

# Lur 4 Legs Wood

Pensi Design Studio

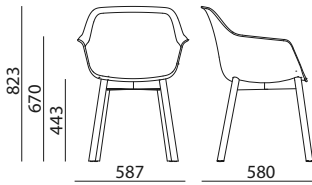

670X570X870 mm 1 unit

Chair with arms, with base of 4 legs in natural varnished oak or black varnished oak. Seat-back-arms in one piece of polypropylene and fibreglass.

Supplementary upholstery only on seat, front upholstery or fully upholstered. Polypropylene glides, felt glides with price increase.

## DRAWING

## SPECIFICATION

## REF.

## €uros

### Lur 4 Legs Wood

**NON UPHOLSTERED** Polypropylene

**LR22/P** 383

**SEAT UPHOLSTERED** Group D

**LR22/D** 448

**SEAT UPHOLSTERED** Group C & COF

**LR22/C** 455

**SEAT UPHOLSTERED** Group B & Valencia

**LR22/B** 474

**SEAT UPHOLSTERED** Group A & COL

**LR22/A** 500

**SEAT UPHOLSTERED** Soft leather

**LR22/L** 506

**FRONT UPHOLSTERED** Group D

**LR23/D** 639

**FRONT UPHOLSTERED** Group C & COF

**LR23/C** 656

**FRONT UPHOLSTERED** Group B & Valencia

**LR23/B** 688

**FRONT UPHOLSTERED** Group A

**LR23/A** 742

**FULLY UPHOLSTERED** Group D

**LR24/D** 642

**FULLY UPHOLSTERED** Group C & COF

**LR24/C** 686

**FULLY UPHOLSTERED** Group B & Valencia

**LR24/B** 754

**FULLY UPHOLSTERED** Group A & COL

**LR24/A** 855

**FULLY UPHOLSTERED** Soft leather

**LR24/L** 961

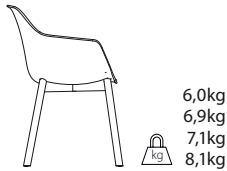

Measure: Only fabric seat 0,52ml/ 3 feet. Measure: Only fabric front 0,77ml. Measure: Fully upholstered 1,5ml/ 18 feet. For projects, please contact the factory.

## ACCESSORIES

## DRAWING

## SPECIFICATION

## REF.

## €uros



**PRICE INCREASE FOR FELT** (per chair)

**ACM1** 12

# Lur 4 Legs with Frame

Pensi Design Studio

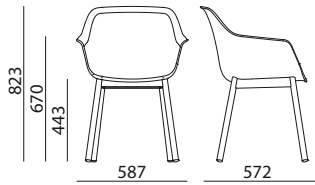

670X570X870 mm 1 unit

Chair with arms, with powder coated steel frame and Ø30mm 4 steel tube legs. Seat-back-arms in one piece of polypropylene and fibreglass.

Supplementary upholstery only on seat, front upholstery or fully upholstered. Polypropylene glides, felt glides with price increase.

## DRAWING

## SPECIFICATION

## REF.

## €uros

### Lur 4 Legs with Frame

**NON UPHOLSTERED** Polypropylene

**LR25/P** 298

**SEAT UPHOLSTERED** Group D

**LR25/D** 362

**SEAT UPHOLSTERED** Group C & COF

**LR25/C** 370

**SEAT UPHOLSTERED** Group B & Valencia

**LR25/B** 388

**SEAT UPHOLSTERED** Group A & COL

**LR25/A** 414

**SEAT UPHOLSTERED** Soft leather

**LR25/L** 421

**FRONT UPHOLSTERED** Group D

**LR26/D** 554

**FRONT UPHOLSTERED** Group C & COF

**LR26/C** 571

**FRONT UPHOLSTERED** Group B & Valencia

**LR26/B** 603

**FRONT UPHOLSTERED** Group A

**LR26/A** 658

**FULLY UPHOLSTERED** Group D

**LR27/D** 557

**FULLY UPHOLSTERED** Group C & COF

**LR27/C** 601

**FULLY UPHOLSTERED** Group B & Valencia

**LR27/B** 670

**FULLY UPHOLSTERED** Group A & COL

**LR27/A** 770

**FULLY UPHOLSTERED** Soft leather

**LR27/L** 876

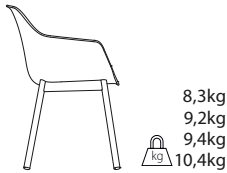

Measure: Only fabric seat 0,52ml/ 3 feet. Measure: Only fabric front 0,77ml. Measure: Fully upholstered 1,5ml/ 18 feet. For projects, please contact the factory.

## ACCESSORIES

## DRAWING

## SPECIFICATION

## REF.

## €uros



**PRICE INCREASE FOR FELT** (per chair)

**AC086** 10

# Lur Office

Pensi Design Studio

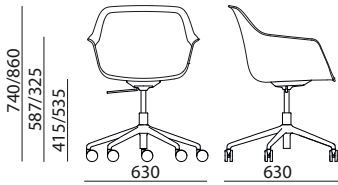

630X630X580 mm 1 unit

Chair with arms, powder coated or polished aluminium 5 arms swivelling base with castors. Gas cylinder elevation. Seat-back-arms in one piece of polypropylene and fibreglass.

Supplementary upholstery only on seat, front upholstery or fully upholstered. Option soft or hard castors.

## DRAWING

## SPECIFICATION

## REF.

## €uros

### Lur Office

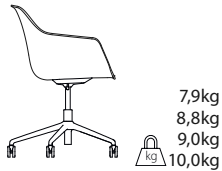

**NON UPHOLSTERED** Polypropylene

**LR28/P** 385

**SEAT UPHOLSTERED** Group D

**LR28/D** 450

**SEAT UPHOLSTERED** Group C & COF

**LR28/C** 457

**SEAT UPHOLSTERED** Group B & Valencia

**LR28/B** 476

**SEAT UPHOLSTERED** Group A & COL

**LR28/A** 502

**SEAT UPHOLSTERED** Soft leather

**LR28/L** 508

**FRONT UPHOLSTERED** Group D

**LR29/D** 641

**FRONT UPHOLSTERED** Group C & COF

**LR29/C** 659

**FRONT UPHOLSTERED** Group B & Valencia

**LR29/B** 690

**FRONT UPHOLSTERED** Group A

**LR29/A** 745

**FULLY UPHOLSTERED** Group D

**LR30/D** 645

**FULLY UPHOLSTERED** Group C & COF

**LR30/C** 689

**FULLY UPHOLSTERED** Group B & Valencia

**LR30/B** 758

**FULLY UPHOLSTERED** Group A & COL

**LR30/A** 857

**FULLY UPHOLSTERED** Soft leather

**LR30/L** 964

**NOTE: ESPECIFY SOFT CASTORS OR HARD CASTORS. IF THERE IS NO SPECIFICATION, HARD CASTORS WILL BE SENT.**  
Measure: Only fabric seat 0,52ml/ 3 feet. Measure: Only fabric front 0,77ml. Measure: Fully upholstered 1,5ml/ 18 feet.  
For projects, please contact the factory.

---

# Klasik

Gabriel Teixidó



Klasik is a wrap-around chair design, born as a new contemporary icon, where craftsmanship and wood meet technology to offer a wide range of finishes and solutions.

Its warmth, elegance and comfort reflect a timeless and classic personality, ideal for any room and circumstance. Thanks to its material and versatility, this chair can be decked out in casual style or given a more formal appearance, always bringing a unique touch to every atmosphere within a same space.

A moulded wooden body lends the chair its beauty and ergonomics, strongly marking its personality and character. It also offers the option of an upholstered seat pad for greater comfort. The possibility of combining different bases make Klasik a complete and flexible family, creating a perfect collection for hospitality and corporate use, and for spaces in the home.

# Klasik 4 Legs

Gabriel Teixidó

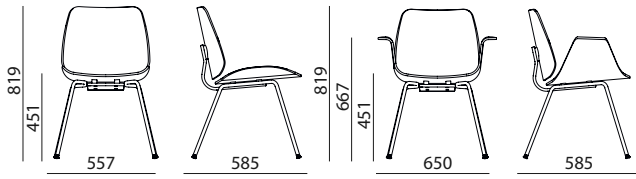

470X410X610 mm 1 unit

Chair with or without arms, frame made of steel tube Ø18mm powder coated or chromed with price increase, polypropylene glides, felt glides with price increase.

Seat and back in oak or walnut with option seat pad upholstered or seat and back pads upholstered.

## DRAWING

## SPECIFICATION

REF. Euros

REF. Euros



7,0kg  
7,9kg  
8,8kg

### Without Arms

- NON UPHOLSTERED** Wood
- SEAT UPHOLSTERED** Group D
- SEAT UPHOLSTERED** Group C & COF
- SEAT UPHOLSTERED** Group B & Valencia
- SEAT UPHOLSTERED** Group A & COL
- SEAT UPHOLSTERED** Soft leather
- SEAT & BACK UPHOLSTERED** Group D
- SEAT & BACK UPHOLSTERED** Group C & COF
- SEAT & BACK UPHOLSTERED** Group B & Valencia
- SEAT & BACK UPHOLSTERED** Group A & COL
- SEAT & BACK UPHOLSTERED** Soft leather
- PRICE INCREASE POLISHED CHROMED**

Oak

Walnut

<b>KL01/W</b>	524	<b>KL05/W</b>	572
<b>KL01/D</b>	595	<b>KL05/D</b>	643
<b>KL01/C</b>	602	<b>KL05/C</b>	648
<b>KL01/B</b>	613	<b>KL05/B</b>	661
<b>KL01/A</b>	630	<b>KL05/A</b>	679
<b>KL01/L</b>	638	<b>KL05/L</b>	684
<b>KL02/D</b>	674	<b>KL06/D</b>	719
<b>KL02/C</b>	689	<b>KL06/C</b>	735
<b>KL02/B</b>	707	<b>KL06/B</b>	752
<b>KL02/A</b>	742	<b>KL06/A</b>	790
<b>KL02/L</b>	760	<b>KL06/L</b>	806
	51		51



7,7kg  
8,6kg  
9,5kg

### With Arms

- NON UPHOLSTERED** Wood
- SEAT UPHOLSTERED** Group D
- SEAT UPHOLSTERED** Group C & COF
- SEAT UPHOLSTERED** Group B & Valencia
- SEAT UPHOLSTERED** Group A & COL
- SEAT UPHOLSTERED** Soft leather
- SEAT & BACK UPHOLSTERED** Group D
- SEAT & BACK UPHOLSTERED** Group C & COF
- SEAT & BACK UPHOLSTERED** Group B & Valencia
- SEAT & BACK UPHOLSTERED** Group A & COL
- SEAT & BACK UPHOLSTERED** Soft leather
- PRICE INCREASE POLISHED CHROMED**

Oak

Walnut

<b>KL03/W</b>	684	<b>KL07/W</b>	745
<b>KL03/D</b>	757	<b>KL07/D</b>	816
<b>KL03/C</b>	762	<b>KL07/C</b>	823
<b>KL03/B</b>	775	<b>KL07/B</b>	834
<b>KL03/A</b>	793	<b>KL07/A</b>	851
<b>KL03/L</b>	798	<b>KL07/L</b>	859
<b>KL04/D</b>	834	<b>KL08/D</b>	895
<b>KL04/C</b>	849	<b>KL08/C</b>	907
<b>KL04/B</b>	867	<b>KL08/B</b>	928
<b>KL04/A</b>	902	<b>KL08/A</b>	963
<b>KL04/L</b>	920	<b>KL08/L</b>	981
	51		51

Measure: Only fabric seat 0.51ml/leather 3 feet. Measure: Seat and back fabric 0.51/leather 6 feet. For projects, please contact the factory.

## ACCESSORIES

### DRAWING

### SPECIFICATION

REF.

Euros



**PRICE INCREASE FOR FELT** (per chair)

**ACK1**

10

# Klasik Sled

Gabriel Teixidó

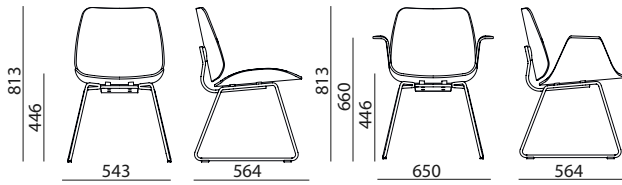

470X410X610 mm 1 unit

Chair with or without arms, frame made of steel tube powder coated or chromed with price increase and with translucent glides.

Seat and back in oak or walnut with option seat pad upholstered or seat and back pads upholstered.

Option translucent glides with felt with price increase.

## DRAWING

## SPECIFICATION

REF. Euros

REF. Euros



7,1kg  
8,0kg  
8,9kg

### Without Arms

**NON UPHOLSTERED** Wood

**SEAT UPHOLSTERED** Group D

**SEAT UPHOLSTERED** Group C & COF

**SEAT UPHOLSTERED** Group B & Valencia

**SEAT UPHOLSTERED** Group A & COL

**SEAT UPHOLSTERED** Soft leather

**SEAT & BACK UPHOLSTERED** Group D

**SEAT & BACK UPHOLSTERED** Group C & COF

**SEAT & BACK UPHOLSTERED** Group B & Valencia

**SEAT & BACK UPHOLSTERED** Group A & COL

**SEAT & BACK UPHOLSTERED** Soft leather

**PRICE INCREASE POLISHED CHROMED**

Oak

Walnut

<b>KL09/W</b>	623	<b>KL13/W</b>	671
<b>KL09/D</b>	694	<b>KL13/D</b>	742
<b>KL09/C</b>	702	<b>KL13/C</b>	747
<b>KL09/B</b>	712	<b>KL13/B</b>	760
<b>KL09/A</b>	729	<b>KL13/A</b>	778
<b>KL09/L</b>	737	<b>KL13/L</b>	783
<b>KL10/D</b>	770	<b>KL14/D</b>	818
<b>KL10/C</b>	785	<b>KL14/C</b>	834
<b>KL10/B</b>	803	<b>KL14/B</b>	851
<b>KL10/A</b>	841	<b>KL14/A</b>	887
<b>KL10/L</b>	859	<b>KL14/L</b>	905
	51		51



7,8kg  
8,7kg  
9,6kg

### With Arms

**NON UPHOLSTERED** Wood

**SEAT UPHOLSTERED** Group D

**SEAT UPHOLSTERED** Group C & COF

**SEAT UPHOLSTERED** Group B & Valencia

**SEAT UPHOLSTERED** Group A & COL

**SEAT UPHOLSTERED** Soft leather

**SEAT & BACK UPHOLSTERED** Group D

**SEAT & BACK UPHOLSTERED** Group C & COF

**SEAT & BACK UPHOLSTERED** Group B & Valencia

**SEAT & BACK UPHOLSTERED** Group A & COL

**SEAT & BACK UPHOLSTERED** Soft leather

**PRICE INCREASE POLISHED CHROMED**

Oak

Walnut

<b>KL11/W</b>	778	<b>KL15/W</b>	839
<b>KL11/D</b>	849	<b>KL15/D</b>	912
<b>KL11/C</b>	856	<b>KL15/C</b>	917
<b>KL11/B</b>	867	<b>KL15/B</b>	930
<b>KL11/A</b>	884	<b>KL15/A</b>	948
<b>KL11/L</b>	892	<b>KL15/L</b>	953
<b>KL12/D</b>	928	<b>KL16/D</b>	989
<b>KL12/C</b>	940	<b>KL16/C</b>	1.004
<b>KL12/B</b>	958	<b>KL16/B</b>	1.022
<b>KL12/A</b>	996	<b>KL16/A</b>	1.057
<b>KL12/L</b>	1.014	<b>KL16/L</b>	1.075
	51		51

NOTE: THE FIRST PRICES ARE FOR THE CHAIR WITHOUT GLIDES. THE GLIDES HAVE A PRICE INCREASE.

Measure: Only fabric seat 0.51ml/leather 3 feet. Measure: Seat and back fabric 0.51/leather 6 feet. For projects, please contact the factory.

## ACCESSORIES

### DRAWING

### SPECIFICATION

REF.

Euros



**PRICE INCREASE FOR FELT** (per chair)

**AC041**

13



# Klasik Wood Legs

Gabriel Teixidó

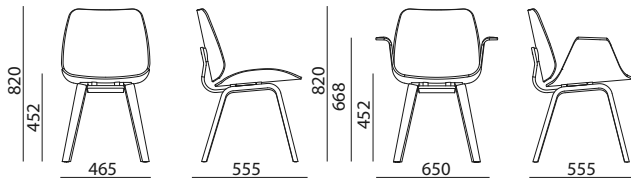

470X410X610 mm 1 unit

Chair with or without arms, 4 legs wood frame in oak or walnut with polypropylene glides, felt glides with price increase.

Seat and back in oak or walnut with option seat pad upholstered or seat and back pads upholstered.

## DRAWING

## SPECIFICATION

REF. Euros

REF. Euros



7,0kg  
7,9kg  
8,8kg

### Without Arms

**NON UPHOLSTERED** Wood

**SEAT UPHOLSTERED** Group D

**SEAT UPHOLSTERED** Group C & COF

**SEAT UPHOLSTERED** Group B & Valencia

**SEAT UPHOLSTERED** Group A & COL

**SEAT UPHOLSTERED** Soft leather

**SEAT & BACK UPHOLSTERED** Group D

**SEAT & BACK UPHOLSTERED** Group C & COF

**SEAT & BACK UPHOLSTERED** Group B & Valencia

**SEAT & BACK UPHOLSTERED** Group A & COL

**SEAT & BACK UPHOLSTERED** Soft leather

Oak

Walnut

<b>KL33/W</b>	707	<b>KL37/W</b>	752
<b>KL33/D</b>	778	<b>KL37/D</b>	826
<b>KL33/C</b>	783	<b>KL37/C</b>	831
<b>KL33/B</b>	796	<b>KL37/B</b>	844
<b>KL33/A</b>	813	<b>KL37/A</b>	862
<b>KL33/L</b>	818	<b>KL37/L</b>	867
<b>KL34/D</b>	854	<b>KL38/D</b>	902
<b>KL34/C</b>	869	<b>KL38/C</b>	917
<b>KL34/B</b>	887	<b>KL38/B</b>	935
<b>KL34/A</b>	923	<b>KL38/A</b>	971
<b>KL34/L</b>	940	<b>KL38/L</b>	989



7,0kg  
7,9kg  
8,8kg

### With Arms

**NON UPHOLSTERED** Wood

**SEAT UPHOLSTERED** Group D

**SEAT UPHOLSTERED** Group C & COF

**SEAT UPHOLSTERED** Group B & Valencia

**SEAT UPHOLSTERED** Group A & COL

**SEAT UPHOLSTERED** Soft leather

**SEAT & BACK UPHOLSTERED** Group D

**SEAT & BACK UPHOLSTERED** Group C & COF

**SEAT & BACK UPHOLSTERED** Group B & Valencia

**SEAT & BACK UPHOLSTERED** Group A & COL

**SEAT & BACK UPHOLSTERED** Soft leather

Oak

Walnut

<b>KL35/W</b>	867	<b>KL39/W</b>	928
<b>KL35/D</b>	938	<b>KL39/D</b>	999
<b>KL35/C</b>	945	<b>KL39/C</b>	1.004
<b>KL35/B</b>	956	<b>KL39/B</b>	1.016
<b>KL35/A</b>	973	<b>KL39/A</b>	1.034
<b>KL35/L</b>	981	<b>KL39/L</b>	1.039
<b>KL36/D</b>	1.014	<b>KL40/D</b>	1.075
<b>KL36/C</b>	1.029	<b>KL40/C</b>	1.090
<b>KL36/B</b>	1.047	<b>KL40/B</b>	1.108
<b>KL36/A</b>	1.085	<b>KL40/A</b>	1.143
<b>KL36/L</b>	1.100	<b>KL40/L</b>	1.161

Measure: Only fabric seat 0.51ml/leather 3 feet. Measure: Seat and back fabric 0.51/leather 6 feet. For projects, please contact the factory.

## ACCESSORIES

## DRAWING

## SPECIFICATION

REF.

Euros



**PRICE INCREASE FOR FELT** (per chair)

**ACM1**

12

# Klasik Swivel

Gabriel Teixidó

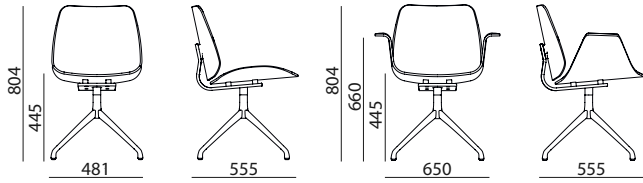

470X410X610 mm 1 unit

Chair with or without arms, swivel powder coated aluminum 4 arm base with fixed height, polished frame with price increase.

Seat and back in oak or walnut with option seat pad upholstered or seat and back pads upholstered.

Option polypropylene glides, felt glides with price increase.

## DRAWING

## SPECIFICATION

REF. Euros

REF. Euros



8,5kg  
9,4kg  
10,3kg

### Without Arms

**NON UPHOLSTERED** Wood

**SEAT UPHOLSTERED** Group D

**SEAT UPHOLSTERED** Group C & COF

**SEAT UPHOLSTERED** Group B & Valencia

**SEAT UPHOLSTERED** Group A & COL

**SEAT UPHOLSTERED** Soft leather

**SEAT & BACK UPHOLSTERED** Group D

**SEAT & BACK UPHOLSTERED** Group C & COF

**SEAT & BACK UPHOLSTERED** Group B & Valencia

**SEAT & BACK UPHOLSTERED** Group A & COL

**SEAT & BACK UPHOLSTERED** Soft leather

**PRICE INCREASE POLISHED BASE P-225**

Oak

Walnut

<b>KL17/W</b>	846	<b>KL21/W</b>	892
<b>KL17/D</b>	917	<b>KL21/D</b>	963
<b>KL17/C</b>	923	<b>KL21/C</b>	971
<b>KL17/B</b>	935	<b>KL21/B</b>	981
<b>KL17/A</b>	953	<b>KL21/A</b>	999
<b>KL07/L</b>	958	<b>KL21/L</b>	1.006
<b>KL18/D</b>	994	<b>KL22/D</b>	1.039
<b>KL18/C</b>	1.009	<b>KL22/C</b>	1.055
<b>KL18/B</b>	1.027	<b>KL22/B</b>	1.072
<b>KL18/A</b>	1.065	<b>KL22/A</b>	1.110
<b>KL18/L</b>	1.080	<b>KL22/L</b>	1.126
	59		59



9,3kg  
10,2kg  
11,1kg

### With Arms

**NON UPHOLSTERED** Wood

**SEAT UPHOLSTERED** Group D

**SEAT UPHOLSTERED** Group C & COF

**SEAT UPHOLSTERED** Group B & Valencia

**SEAT UPHOLSTERED** Group A & COL

**SEAT UPHOLSTERED** Soft leather

**SEAT & BACK UPHOLSTERED** Group D

**SEAT & BACK UPHOLSTERED** Group C & COF

**SEAT & BACK UPHOLSTERED** Group B & Valencia

**SEAT & BACK UPHOLSTERED** Group A & COL

**SEAT & BACK UPHOLSTERED** Soft leather

**PRICE INCREASE POLISHED BASE P-225**

Oak

Walnut

<b>KL19/W</b>	1.001	<b>KL23/W</b>	1.060
<b>KL19/D</b>	1.072	<b>KL23/D</b>	1.133
<b>KL19/C</b>	1.080	<b>KL23/C</b>	1.138
<b>KL19/B</b>	1.090	<b>KL23/B</b>	1.151
<b>KL19/A</b>	1.108	<b>KL23/A</b>	1.169
<b>KL19/L</b>	1.116	<b>KL23/L</b>	1.174
<b>KL20/D</b>	1.151	<b>KL24/D</b>	1.210
<b>KL20/C</b>	1.164	<b>KL24/C</b>	1.225
<b>KL20/B</b>	1.182	<b>KL24/B</b>	1.243
<b>KL20/A</b>	1.220	<b>KL24/A</b>	1.278
<b>KL20/L</b>	1.237	<b>KL24/L</b>	1.296
	59		59

Measure: Only fabric seat 0.51ml/leather 3 feet. Measure: Seat and back fabric 0.51/leather 6 feet. For projects, please contact the factory.

## ACCESSORIES

## DRAWING

## SPECIFICATION

REF.

Euros



**PRICE INCREASE FOR FELT** (per chair)

**ACP1**

14

# Klasik Swivel with Castors

Gabriel Teixidó

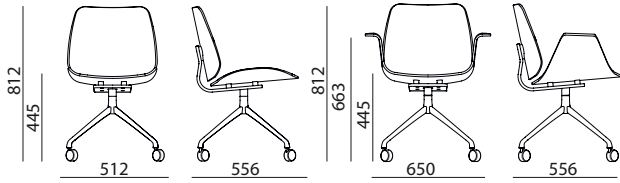

470X410X610 mm 1 unit

Chair with or without arms, swivel powder coated aluminum 4 arm base with fixed height and castors, polished frame with price increase.

Seat and back in oak or walnut with option seat pad upholstered or seat and back pads upholstered.

Option for hard or soft castors.

## DRAWING

## SPECIFICATION

REF. Euros

REF. Euros

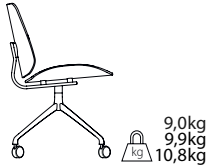

### Without Arms

- NON UPHOLSTERED** Wood
- SEAT UPHOLSTERED** Group D
- SEAT UPHOLSTERED** Group C & COF
- SEAT UPHOLSTERED** Group B & Valencia
- SEAT UPHOLSTERED** Group A & COL
- SEAT UPHOLSTERED** Soft leather
- SEAT & BACK UPHOLSTERED** Group D
- SEAT & BACK UPHOLSTERED** Group C & COF
- SEAT & BACK UPHOLSTERED** Group B & Valencia
- SEAT & BACK UPHOLSTERED** Group A & COL
- SEAT & BACK UPHOLSTERED** Soft leather
- PRICE INCREASE POLISHED BASE P-225**

9,0kg  
9,9kg  
10,8kg

	Oak	Walnut
<b>KL25/W</b>	798	<b>KL29/W</b> 846
<b>KL25/D</b>	869	<b>KL29/D</b> 917
<b>KL25/C</b>	877	<b>KL29/C</b> 923
<b>KL25/B</b>	887	<b>KL29/B</b> 935
<b>KL25/A</b>	905	<b>KL29/A</b> 953
<b>KL25/L</b>	912	<b>KL29/L</b> 958
<b>KL26/D</b>	945	<b>KL30/D</b> 994
<b>KL26/C</b>	961	<b>KL30/C</b> 1.009
<b>KL26/B</b>	978	<b>KL30/B</b> 1.027
<b>KL26/A</b>	1.016	<b>KL30/A</b> 1.065
<b>KL26/L</b>	1.032	<b>KL30/L</b> 1.080
	24	24

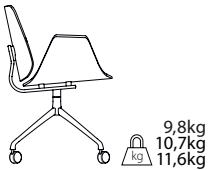

### With Arms

- NON UPHOLSTERED** Wood
- SEAT UPHOLSTERED** Group D
- SEAT UPHOLSTERED** Group C & COF
- SEAT UPHOLSTERED** Group B & Valencia
- SEAT UPHOLSTERED** Group A & COL
- SEAT UPHOLSTERED** Soft leather
- SEAT & BACK UPHOLSTERED** Group D
- SEAT & BACK UPHOLSTERED** Group C & COF
- SEAT & BACK UPHOLSTERED** Group B & Valencia
- SEAT & BACK UPHOLSTERED** Group A & COL
- SEAT & BACK UPHOLSTERED** Soft leather
- PRICE INCREASE POLISHED BASE P-225**

9,8kg  
10,7kg  
11,6kg

	Oak	Walnut
<b>KL27/W</b>	953	<b>KL31/W</b> 1.014
<b>KL27/D</b>	1.024	<b>KL31/D</b> 1.085
<b>KL27/C</b>	1.032	<b>KL31/C</b> 1.093
<b>KL27/B</b>	1.042	<b>KL31/B</b> 1.103
<b>KL27/A</b>	1.060	<b>KL31/A</b> 1.121
<b>KL27/L</b>	1.067	<b>KL31/L</b> 1.128
<b>KL28/D</b>	1.100	<b>KL32/D</b> 1.161
<b>KL28/C</b>	1.116	<b>KL32/C</b> 1.177
<b>KL28/B</b>	1.133	<b>KL32/B</b> 1.194
<b>KL28/A</b>	1.171	<b>KL32/A</b> 1.232
<b>KL28/L</b>	1.187	<b>KL32/L</b> 1.248
	24	24

NOTE: SPECIFY SOFT CASTORS OR HARD CASTORS. IF THERE IS NO SPECIFICATION, HARD CASTORS WILL BE SENT.  
Measure: Only fabric seat 0.51ml/leather 3 feet. Measure: Seat and back fabric 0.51/leather 6 feet. For projects, please contact the factory.

---

# Kabi

Pensi Design Studio



Kabi means “nest” in our Basque language. Just sit on this chair and you’ll see why it gets its name. It’s that place that cuddles you, protects you and makes you feel good. It doesn’t take much to make you feel this comfortable. That’s the key to the small pleasures. And that’s the key to Kabi: maximum sensations with minimum resources.

Kabi is a complete range of chairs designed around a Polypropylene shell. A subtly flexible back allows each user to sit comfortably, to create their nest, to feel at home. Total well-being with a timeless image fully customizable with fabric or leather upholstery. The colours customize the seat, the structure and the legs.

Kabi is highly versatile and functions well for widely differing spaces and uses. You may find your nest in a restaurant or bar, perhaps as the basic chair with no armrests. It can also come with a swivelling aluminium base or with multilaminated wooden legs, ideal for offices or hotels. The bases with or without castors and the two heights multiply the possibilities of their use.

Although Kabi has discreet elegance as its essence, it can also stand out for its colour. We have a Kabi for every space and every person. We can help you to create your own Kabi; we adapt to your needs.

# Kabi 4 Legs



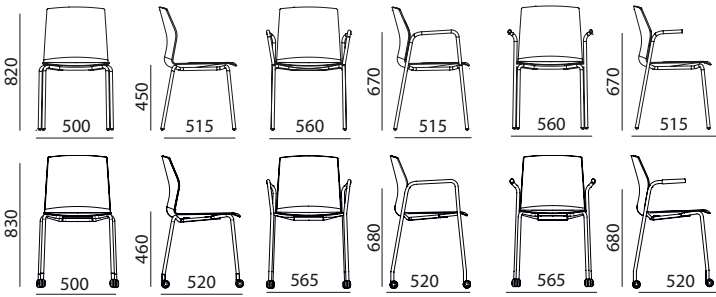



Pensi Design Studio



Stackable chair without or with arms (open and closed) and with the option of adding a desk tray.

Structure made of powder coated steel tube of Ø16mm for chair without arms and Ø20mm tube structure for chair with arms (open and closed) and for all versions with castors; option of hard or soft castors. Option for chromed finish with a price increase. Seat and back in one piece of Polypropylene.

Front upholstery only on seat or fully upholstered. With the additional option for stacking bumper to protect the seat pad upholstery when stacked. Polypropylene glides, option for felt with a price increase.

Without castors  610x730x1080mm  4 units  10 units  Expedition in 5 working days (Max. 50 units)  
 With castors  610x730x1080mm  4 units  6 units

## DRAWING

## SPECIFICATION

REF. Euros

REF. Euros

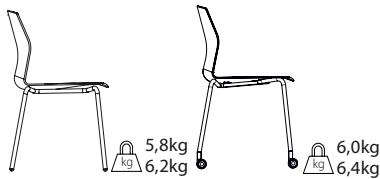

### Without Arms

- NON UPHOLSTERED** Polypropylene 
- SEAT UPHOLSTERED** Group D
- SEAT UPHOLSTERED** Group C & COF
- SEAT UPHOLSTERED** Group B & Valencia
- SEAT UPHOLSTERED** Group A & COL
- SEAT UPHOLSTERED** Soft leather
- FULLY UPHOLSTERED** Group D
- FULLY UPHOLSTERED** Group C & COF
- FULLY UPHOLSTERED** Group B & Valencia
- FULLY UPHOLSTERED** Group A & COL
- FULLY UPHOLSTERED** Soft leather
- CHROME SUPPLEMENT**

	Without castors	With castors (*)
<b>KB01/P</b>	161	<b>KBR1/P</b> 213
<b>KB01/D</b>	241	<b>KBR1/D</b> 296
<b>KB01/C</b>	246	<b>KBR1/C</b> 300
<b>KB01/B</b>	257	<b>KBR1/B</b> 312
<b>KB01/A</b>	275	<b>KBR1/A</b> 328
<b>KB01/L</b>	321	<b>KBR1/L</b> 374
<b>KB04/D</b>	262	<b>KBR4/D</b> 317
<b>KB04/C</b>	282	<b>KBR4/C</b> 335
<b>KB04/B</b>	307	<b>KBR4/B</b> 360
<b>KB04/A</b>	371	<b>KBR4/A</b> 424
<b>KB04/L</b>	511	<b>KBR4/L</b> 564
	46	46

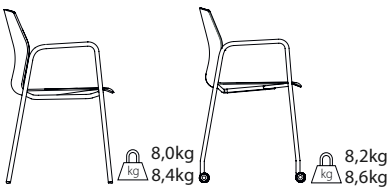

### With Arms Closed

- NON UPHOLSTERED** Polypropylene
- SEAT UPHOLSTERED** Group D
- SEAT UPHOLSTERED** Group C & COF
- SEAT UPHOLSTERED** Group B & Valencia
- SEAT UPHOLSTERED** Group A & COL
- SEAT UPHOLSTERED** Soft leather
- FULLY UPHOLSTERED** Group D
- FULLY UPHOLSTERED** Group C & COF
- FULLY UPHOLSTERED** Group B & Valencia
- FULLY UPHOLSTERED** Group A & COL
- FULLY UPHOLSTERED** Soft leather
- CHROME SUPPLEMENT**

	Without castors	With castors (*)
<b>KB03/P</b>	211	<b>KBR3/P</b> 266
<b>KB03/D</b>	291	<b>KBR3/D</b> 346
<b>KB03/C</b>	298	<b>KBR3/C</b> 351
<b>KB03/B</b>	310	<b>KBR3/B</b> 365
<b>KB03/A</b>	326	<b>KBR3/A</b> 381
<b>KB03/L</b>	371	<b>KBR3/L</b> 426
<b>KB06/D</b>	314	<b>KBR6/D</b> 367
<b>KB06/C</b>	333	<b>KBR6/C</b> 388
<b>KB06/B</b>	358	<b>KBR6/B</b> 413
<b>KB06/A</b>	422	<b>KBR6/A</b> 477
<b>KB06/L</b>	562	<b>KBR6/L</b> 617
	74	74

(\*) NOTE: THE VERSIONS WITH CASTORS ARE MADE OF Ø20mm TUBE. SPECIFY HARD OR SOFT CASTORS. IF NOT SPECIFIED, HARD CASTORS WILL BE SENT.  
 Measure: Only seat 0,55m/ 3 feet. Measure: Fully upholstered 0,86m/15 feet. For projects, please contact the factory.

# Kabi 4 Legs

Pensi Design Studio

DRAWING	SPECIFICATION	REF.	€uros	REF.	€uros	
	<p><u>With Arms Open</u></p> <p><b>NON UPHOLSTERED</b> Polypropylene</p> <p><b>SEAT UPHOLSTERED</b> Group D</p> <p><b>SEAT UPHOLSTERED</b> Group C &amp; COF</p> <p><b>SEAT UPHOLSTERED</b> Group B &amp; Valencia</p> <p><b>SEAT UPHOLSTERED</b> Group A &amp; COL</p> <p><b>SEAT UPHOLSTERED</b> Soft leather</p> <p><b>FULLY UPHOLSTERED</b> Group D</p> <p><b>FULLY UPHOLSTERED</b> Group C &amp; COF</p> <p><b>FULLY UPHOLSTERED</b> Group B &amp; Valencia</p> <p><b>FULLY UPHOLSTERED</b> Group A &amp; COL</p> <p><b>FULLY UPHOLSTERED</b> Soft leather</p> <p><b>CHROME SUPPLEMENT</b></p>			Without castors	With castors	
			<b>KB02/P</b>	234	<b>KBR2/P</b>	289
			<b>KB02/D</b>	317	<b>KBR2/D</b>	369
			<b>KB02/C</b>	321	<b>KBR2/C</b>	374
			<b>KB02/B</b>	333	<b>KBR2/B</b>	385
			<b>KB02/A</b>	349	<b>KBR2/A</b>	404
			<b>KB02/L</b>	394	<b>KBR2/L</b>	449
			<b>KB05/D</b>	335	<b>KBR5/D</b>	390
			<b>KB05/C</b>	355	<b>KBR5/C</b>	410
			<b>KB05/B</b>	381	<b>KBR5/B</b>	436
			<b>KB05/A</b>	445	<b>KBR5/A</b>	500
			<b>KB05/L</b>	584	<b>KBR5/L</b>	639
				74		74

(\*) NOTE: THE VERSIONS WITH CASTORS ARE MADE OF Ø20mm TUBE. SPECIFY HARD OR SOFT CASTORS. IF NOT SPECIFIED, HARD CASTORS WILL BE SENT.

Measure: Only seat 0,55m/ 3 feet. Measure: Fully upholstered 0,86m/15 feet. For projects, please contact the factory.



## ACCESSORIES

DRAWING	SPECIFICATION	REF.	€uros
	<p><b>PRICE INCREASE FOR FELT</b> (per chair)</p>	<b>AC015</b>	10
	<p><b>STACKING BUMPER FOR UPHOLSTERED VERSIONS</b> Black or white (per chair)</p>	<b>AC018</b>	26
	<p><b>PRICE INCREASE CHAIR PREPARED FOR DESK TRAY</b> (per chair)</p>	<b>AC010</b>	19
	<p><b>DESK TRAY FOR CHAIR WITHOUT OR WITH ARM</b> Right (compact black or white)</p>	<b>AC011</b>	122
	<p><b>DESK TRAY FOR CHAIR WITHOUT OR WITH ARM</b> Left (compact black or white)</p>	<b>AC012</b>	122
	<p><b>TRANSPORT AND STORAGE TROLLEY</b> (powder coated) 14 units</p>	<b>AC016</b>	367
	<p><b>TRANSPORT TROLLEY</b> (powder coated) 6-8 units</p>	<b>AC017</b>	802
	<p><b>LINKING DEVICE</b></p>	<b>AC019</b>	51

# Kabi Non-Stackable

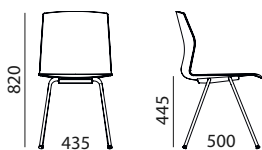
Pensi Design Studio



 680x560x840mm  2 units

Non-stackable chair without arms. Ø16mm powder coated steel tube structure, with chrome option with supplement.

Seat-backrest in one piece of 70% Polypropylene + 30% F.G. Supplementary upholstery only on seat or fully upholstered.

Polypropylene glides, option for felt with a price increase.

## DRAWING

## SPECIFICATION

## REF.

## €uros

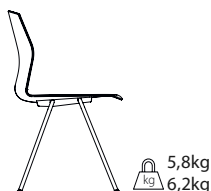

### Without Arms

**NON UPHOLSTERED** Polypropylene

**KB58/P** 177

**SEAT UPHOLSTERED** Group D

**KB58/D** 259

**SEAT UPHOLSTERED** Group C & COF

**KB58/C** 264

**SEAT UPHOLSTERED** Group B & Valencia

**KB58/B** 275

**SEAT UPHOLSTERED** Group A & COL

**KB58/A** 294

**SEAT UPHOLSTERED** Soft leather

**KB58/L** 339

**FULLY UPHOLSTERED** Group D

**KB59/D** 280

**FULLY UPHOLSTERED** Group C & COF

**KB59/C** 300

**FULLY UPHOLSTERED** Group B & Valencia

**KB59/B** 326

**FULLY UPHOLSTERED** Group A & COL

**KB59/A** 390

**FULLY UPHOLSTERED** Soft leather

**KB59/L** 529

**CHROME SUPPLEMENT**

46

Measure: Only seat 0,55ml/ 3 feet. Measure: Fully upholstered 0,86ml/15 feet. For projects, please contact the factory.

## ACCESSORIES

## DRAWING

## SPECIFICATION

## REF.

## €uros





**PRICE INCREASE FOR FELT** (per chair)

**AC015** 10

# Kabi Wood Legs

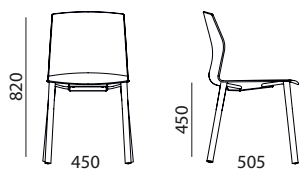
Pensi Design Studio



 680x560x840mm  2 units

Non-stackable chair without arms Four legs frame of natural stained wood.

Seat-backrest in one piece of 70% Polypropylene + 30% F.G. Supplementary upholstery only on seat or fully upholstered.

Polypropylene glides, option for felt with a price increase.

DRAWING	SPECIFICATION	REF.	€uros
	<b>Kabi Wood Legs</b>		
	<b>NON UPHOLSTERED</b> Polypropylene	<b>KBM1/P</b>	303
	<b>SEAT UPHOLSTERED</b> Group D	<b>KBM1/D</b>	385
	<b>SEAT UPHOLSTERED</b> Group C & COF	<b>KBM1/C</b>	390
	<b>SEAT UPHOLSTERED</b> Group B & Valencia	<b>KBM1/B</b>	401
	<b>SEAT UPHOLSTERED</b> Group A & COL	<b>KBM1/A</b>	420
	<b>SEAT UPHOLSTERED</b> Soft leather	<b>KBM1/L</b>	463
	<b>FULLY UPHOLSTERED</b> Group D	<b>KBM4/D</b>	406
	<b>FULLY UPHOLSTERED</b> Group C & COF	<b>KBM4/C</b>	426
	<b>FULLY UPHOLSTERED</b> Group B & Valencia	<b>KBM4/B</b>	452
<b>FULLY UPHOLSTERED</b> Group A & COL	<b>KBM4/A</b>	516	
<b>FULLY UPHOLSTERED</b> Soft leather	<b>KBM4/L</b>	655	

NOTE: FOR OTHER COLOURS CHECK WITH FACTORY MINIMUM BATCH AND TERM.

Measure: Only seat 0,55ml/ 3 feet. Measure: Fully upholstered 0,86ml/15 feet. For projects, please contact the factory.

## ACCESSORIES

DRAWING	SPECIFICATION	REF.	€uros
	<b>PRICE INCREASE FOR FELT</b> (per chair)	<b>ACM1</b>	12



# Kabi Sled

Pensi Design Studio

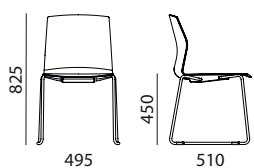

 610x730x1080mm

 4 units

 10 units

Stackable chair without arms and with option of desk tray with supplement.

Frame made of steel tube of Ø14mm powder coated. Seat and back in one piece of Polypropylene. Front upholstery only on seat or fully upholstered.

Translucent glides included, with felt option with price increase.

## DRAWING

## SPECIFICATION

## REF.

## €uros

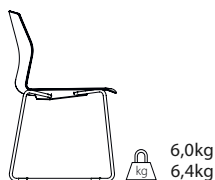

### Without Arms

**NON UPHOLSTERED** Polypropylene

**KB60/P** 179

**SEAT UPHOLSTERED** Group D

**KB60/D** 262

**SEAT UPHOLSTERED** Group C & COF

**KB60/C** 266

**SEAT UPHOLSTERED** Group B & Valencia

**KB60/B** 278

**SEAT UPHOLSTERED** Group A & COL

**KB60/A** 296

**SEAT UPHOLSTERED** Soft leather

**KB60/L** 342

**FULLY UPHOLSTERED** Group D

**KB61/D** 282

**FULLY UPHOLSTERED** Group C & COF

**KB61/C** 303

**FULLY UPHOLSTERED** Group B & Valencia

**KB61/B** 328

**FULLY UPHOLSTERED** Group A & COL

**KB61/A** 392

**FULLY UPHOLSTERED** Soft leather

**KB61/L** 532

**CHROME SUPPLEMENT**

35

Measure: Only seat 0,55m/ 3 feet. Measure: Fully upholstered 0,86m/15 feet. For projects, please contact the factory.

## ACCESSORIES

## DRAWING

## SPECIFICATION

## REF.

## €uros



**PRICE INCREASE FOR FELT** (per chair)

**AC041** 13

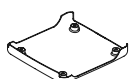

**STACKING BUMPER FOR UPHOLSTERED VERSIONS**  
Black or white.

**AC018** 26





**LINKING DEVICE**

**AC026** 51

# Kabi Sled

Pensi Design Studio

## ACCESSORIES

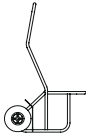
DRAWING	SPECIFICATION	REF.	Euros
	<b>PRICE INCREASE CHAIR PREPARED FOR DESK TRAY</b> (per chair)	<b>AC020</b>	20
	<b>DESK TRAY FOR CHAIR WITHOUT ARMS RIGHT</b> (compact black or white)	<b>AC021</b>	122
	<b>DESK TRAY FOR CHAIR WITHOUT ARMS LEFT</b> (compact black or white)	<b>AC022</b>	122
	<b>TRANSPORT AND STORAGE TROLLEY</b> (powder coated) 14 units	<b>AC016</b>	367
	<b>TRANSPORT TROLLEY</b> (powder coated) 6-8 units	<b>AC017</b>	802

# Kabi High Chair

Pensi Design Studio

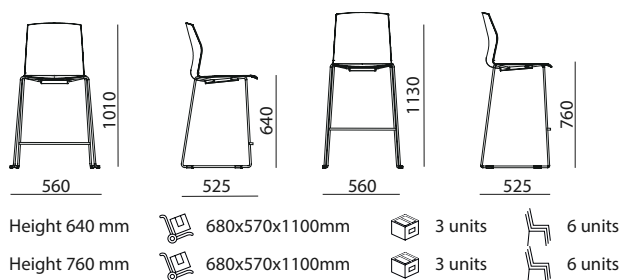

Stackable high chair without arms, frame made of solid powder coated steel wire of Ø12mm. Option for chromed finish.

Seat and back in one piece of 70% Polypropylene + 30% F.G. Supplementary upholstery only on seat or fully upholstered.

Polypropylene glides, felt glides with price increase.

## DRAWING

## SPECIFICATION

## REF.

## €uros



### Height 640mm

- NON UPHOLSTERED** Polypropylene
- SEAT UPHOLSTERED** Group D
- SEAT UPHOLSTERED** Group C & COF
- SEAT UPHOLSTERED** Group B & Valencia
- SEAT UPHOLSTERED** Group A & COL
- SEAT UPHOLSTERED** Soft leather
- FULLY UPHOLSTERED** Group D
- FULLY UPHOLSTERED** Group C & COF
- FULLY UPHOLSTERED** Group B & Valencia
- FULLY UPHOLSTERED** Group A & COL
- FULLY UPHOLSTERED** Soft leather
- CHROME SUPPLEMENT**

<b>KB11/P</b>	291
<b>KB11/D</b>	374
<b>KB11/C</b>	378
<b>KB11/B</b>	390
<b>KB11/A</b>	406
<b>KB11/L</b>	452
<b>KB13/D</b>	394
<b>KB13/C</b>	413
<b>KB13/B</b>	438
<b>KB13/A</b>	502
<b>KB13/L</b>	642
	58

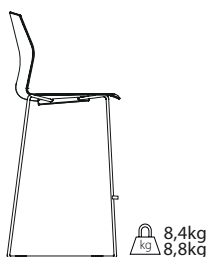

### Height 760mm

- NON UPHOLSTERED** Polypropylene
- SEAT UPHOLSTERED** Group D
- SEAT UPHOLSTERED** Group C & COF
- SEAT UPHOLSTERED** Group B & Valencia
- SEAT UPHOLSTERED** Group A & COL
- SEAT UPHOLSTERED** Soft leather
- FULLY UPHOLSTERED** Group D
- FULLY UPHOLSTERED** Group C & COF
- FULLY UPHOLSTERED** Group B & Valencia
- FULLY UPHOLSTERED** Group A & COL
- FULLY UPHOLSTERED** Soft leather
- CHROME SUPPLEMENT**

<b>KB12/P</b>	300
<b>KB12/D</b>	383
<b>KB12/C</b>	388
<b>KB12/B</b>	399
<b>KB12/A</b>	417
<b>KB12/L</b>	461
<b>KB14/D</b>	404
<b>KB14/C</b>	424
<b>KB14/B</b>	449
<b>KB14/A</b>	511
<b>KB14/L</b>	653
	58

Measure: Only seat 0,55ml/ 3 feet. Measure: Fully upholstered 0,86ml/15 feet. For projects, please contact the factory.

## ACCESSORIES

### DRAWING

### SPECIFICATION

### REF.

### €uros



**PRICE INCREASE FOR FELT** (per chair)

**AC025** 21

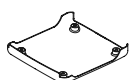





**STACKING BUMPER FOR UPHOLSTERED VERSIONS**  
Black or white (per chair)

**AC018** 26

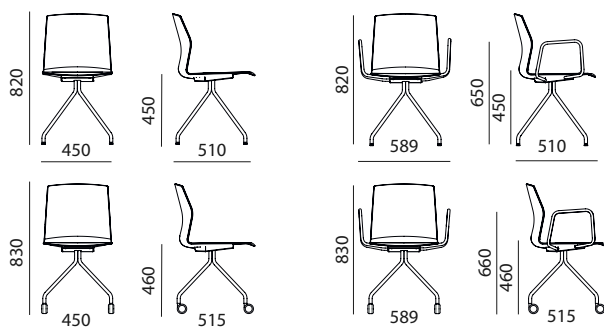
# Kabi Pyramid Tube

Pensi Design Studio



Without castors  590x670x1150mm  2 unit  
 With castors  590x670x1150mm  2 unit

Pyramidal chair without swivel, with or without arms. Pyramidal structure with 4 arms base in steel tube of Ø20mm painted. Optional tube arms powder coated or chromed steel tube arms with price increase. Seat and back in one piece of 70% Polypropylene + 30% F.G.

Supplementary upholstery only on seat or fully upholstered. Option for felt glides, soft or hard castors.

## DRAWING

## SPECIFICATION

## REF.

## €uros

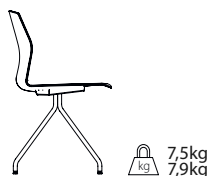

### Without Arms

**NON UPHOLSTERED** Polypropylene

**KB62/P** 273

**SEAT UPHOLSTERED** Group D

**KB62/D** 353

**SEAT UPHOLSTERED** Group C & COF

**KB62/C** 358

**SEAT UPHOLSTERED** Group B & Valencia

**KB62/B** 371

**SEAT UPHOLSTERED** Group A & COL

**KB62/A** 388

**SEAT UPHOLSTERED** Soft leather

**KB62/L** 433

**FULLY UPHOLSTERED** Group D

**KB63/D** 374

**FULLY UPHOLSTERED** Group C & COF

**KB63/C** 394

**FULLY UPHOLSTERED** Group B & Valencia

**KB63/B** 420

**FULLY UPHOLSTERED** Group A & COL

**KB63/A** 484

**FULLY UPHOLSTERED** Soft leather

**KB63/L** 623

Measure: Only seat 0,55ml/ 3 feet. Measure: Fully upholstered 0,86ml/15 feet. For projects, please contact the factory.

## ACCESSORIES

## DRAWING

## SPECIFICATION

## REF.

## €uros



**PRICE INCREASE FOR FELT** (per chair)

**AC015** 10



 + 0,5kg

**PRICE INCREASE FOR CASTORS** (per chair)

**AC030** 23

NOTE: SPECIFY HARD OR SOFT CASTORS. IF NOT SPECIFIED, HARD CASTORS WILL BE SENT.



 + 2,0kg

**PRICE INCREASE CLOSED ARMS POWDER COATED** (per chair)

**AC031** 92



 + 2,0kg



**PRICE INCREASE CLOSED ARMS CHROMED** (per chair)

**AC032** 142

# Kabi Swivel

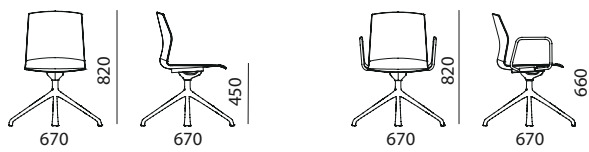
Pensi Design Studio



 590x670x1150mm  2 units

Chair without or with close arms and swivel base.

Swivel powder coated, polished aluminium 4 arm base. Optional powder coated, chromed steel tube closed armsh with price increase. Seat and back in one piece of 70% Polypropylene + 30% F.G.

Supplementary upholstery only on seat or fully upholstered. Option for felt glides, soft or hard castors.

## DRAWING

## SPECIFICATION

## REF.

## €uros

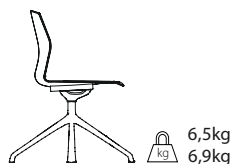

### Without Arms

**NON UPHOLSTERED** Polypropylene

**KB15/P** 371

**SEAT UPHOLSTERED** Group D

**KB15/D** 452

**SEAT UPHOLSTERED** Group C & COF

**KB15/C** 456

**SEAT UPHOLSTERED** Group B & Valencia

**KB15/B** 470

**SEAT UPHOLSTERED** Group A & COL

**KB15/A** 486

**SEAT UPHOLSTERED** Soft leather

**KB15/L** 532

**FULLY UPHOLSTERED** Group D

**KB16/D** 472

**FULLY UPHOLSTERED** Group C & COF

**KB16/C** 493

**FULLY UPHOLSTERED** Group B & Valencia

**KB16/B** 518

**FULLY UPHOLSTERED** Group A & COL

**KB16/A** 582

**FULLY UPHOLSTERED** Soft leather

**KB16/L** 722

Measure: Only seat 0,55ml/ 3 feet. Measure: Fully upholstered 0,86ml/15 feet. For projects, please contact the factory.

## ACCESSORIES

## DRAWING

## SPECIFICATION

## REF.

## €uros



**PRICE INCREASE FOR FELT** (per chair)

**AC039** 19



 + 0,5kg

**PRICE INCREASE FOR CASTORS** (per chair)

**AC030** 23

NOTE: SPECIFY HARD OR SOFT CASTORS. IF NOT SPECIFIED, HARD CASTORS WILL BE SENT.



 + 2,0kg

**PRICE INCREASE CLOSED ARMS POWDER COATED** (per chair)

**AC031** 92



 + 2,0kg

**PRICE INCREASE CLOSED ARMS CHROMED** (per chair)

**AC032** 142

# Kabi Office

Pensi Design Studio

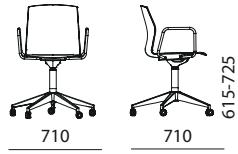
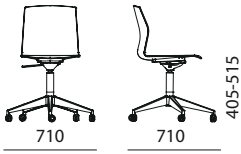

Chair with or without arms, height adjustable and with castors. Base in black or white polyamide with the option for polished aluminium, powder coated finish. Gas cylinder. Seat and back in one piece of 70% Polypropylene + 30% F.G.

Supplementary upholstery only on seat or fully upholstered. Option soft or hard castors.

630x630x580mm 1 unit

DRAWING

SPECIFICATION

REF.

€uros



## Without Arms

**NON UPHOLSTERED** Polypropylene

**KB17/P** 339

**SEAT UPHOLSTERED** Group D

**KB17/D** 422

**SEAT UPHOLSTERED** Group C & COF

**KB17/C** 426

**SEAT UPHOLSTERED** Group B & Valencia

**KB17/B** 438

**SEAT UPHOLSTERED** Group A & COL

**KB17/A** 454

**SEAT UPHOLSTERED** Soft leather

**KB17/L** 500

**FULLY UPHOLSTERED** Group D

**KB18/D** 442

**FULLY UPHOLSTERED** Group C & COF

**KB18/C** 461

**FULLY UPHOLSTERED** Group B & Valencia

**KB18/B** 486

**FULLY UPHOLSTERED** Group A & COL

**KB18/A** 550

**FULLY UPHOLSTERED** Soft leather

**KB18/L** 690

NOTE: SPECIFY HARD OR SOFT CASTORS. IF NOT SPECIFIED, HARD CASTORS WILL BE SENT.

BLACK, WHITE OR GREY POLYAMIDE BASE.

Measure: Only seat 0,55m/3 feet. Measure: Fully upholstered 0,86m/15 feet. For projects, please contact the factory.

## ACCESSORIES

DRAWING

SPECIFICATION

REF.

€uros



**PRICE INCREASE FOR POWDER COATED, POLISHED ALUMINIUM BASE**

**AC033** 92

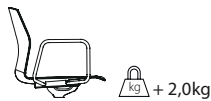

**PRICE INCREASE CLOSED ARMS POWDER COATED**  
(per chair)

**AC031** 92



**PRICE INCREASE FOR CLOSED ARMS CHROMED**  
(per chair)

**AC032** 142

# Kabi Office High Chair

Pensi Design Studio

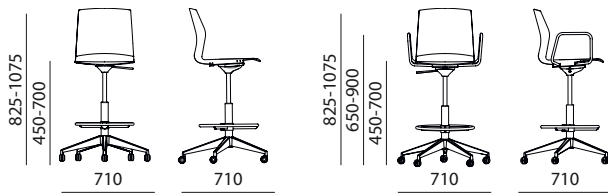

Chair with or without arms, height adjustable and with castors. Base in black or white polyamide with the option for polished aluminium, powder coated finish. Gas cylinder and chrome footrest. Seat and back in one piece of 70% Polypropylene + 30% F.G.

Supplementary upholstery only on seat or fully upholstered. Option soft or hard castors.

630x630x580mm 1 unit

## DRAWING

## SPECIFICATION

## REF.

## €uros



### Without Arms

**NON UPHOLSTERED** Polypropylene

**SEAT UPHOLSTERED** Group D

**SEAT UPHOLSTERED** Group C & COF

**SEAT UPHOLSTERED** Group B & Valencia

**SEAT UPHOLSTERED** Group A & COL

**SEAT UPHOLSTERED** Soft leather

**FULLY UPHOLSTERED** Group D

**FULLY UPHOLSTERED** Group C & COF

**FULLY UPHOLSTERED** Group B & Valencia

**FULLY UPHOLSTERED** Group A & COL

**FULLY UPHOLSTERED** Soft leather

**KB64/P**

445

**KB64/D**

527

**KB64/C**

532

**KB64/B**

543

**KB64/A**

559

**KB64/L**

605

**KB65/D**

548

**KB65/C**

566

**KB65/B**

591

**KB65/A**

655

**KB65/L**

795

NOTE: SPECIFY HARD OR SOFT CASTORS. IF NOT SPECIFIED, HARD CASTORS WILL BE SENT.

BLACK, WHITE OR GREY POLYAMIDE BASE.

Measure: Only seat 0,55ml/3 feet. Measure: Fully upholstered 0,86ml/15 feet. For projects, please contact the factory.

## ACCESSORIES

## DRAWING

## SPECIFICATION

## REF.

## €uros



**PRICE INCREASE FOR POWDER COATED, POLISHED ALUMINIUM BASE**

**AC033**

92



**PRICE INCREASE CLOSED ARMS POWDER COATED**  
(per chair)

**AC031**

92



**PRICE INCREASE FOR CLOSED ARMS CHROMED**  
(per chair)

**AC032**

142

# Kabi Office with Desk Tray

Pensi Design Studio



 630x630x580

 1 unit

Office chair with 5 star base in black or white polyamide with the option for polished aluminium, powder coated finish with castors. Gas cylinder. Seat and back in one piece of 70% Polypropylene + 30% F.G.

Supplementary upholstery only on seat or fully upholstered. Option soft or hard castors.

Rotating desk tray in white or black compact.

## DRAWING

## SPECIFICATION

## REF.

## €uros



### Kabi Office with Desk Tray

**NON UPHOLSTERED** Polypropylene

**KB30/P** 555

**SEAT UPHOLSTERED** Group D

**KB30/D** 637

**SEAT UPHOLSTERED** Group C & COF

**KB30/C** 642

**SEAT UPHOLSTERED** Group B & Valencia

**KB30/B** 653

**SEAT UPHOLSTERED** Group A & COL

**KB30/A** 669

**SEAT UPHOLSTERED** Soft leather

**KB30/L** 715

**FULLY UPHOLSTERED** Group D

**KB31/D** 658

**FULLY UPHOLSTERED** Group C & COF

**KB31/C** 678

**FULLY UPHOLSTERED** Group B & Valencia

**KB31/B** 704

**FULLY UPHOLSTERED** Group A & COL

**KB31/A** 765

**FULLY UPHOLSTERED** Soft leather

**KB31/L** 907

NOTE: SPECIFY HARD OR SOFT CASTORS. IF NOT SPECIFIED, HARD CASTORS WILL BE SENT. BLACK, WHITE POLYAMIDE BASE.

Measure: Only seat 0,55m/3 feet. Measure: Fully upholstered 0,86m/15 feet. For projects, please contact the factory.

## ACCESSORIES

## DRAWING

## SPECIFICATION

## REF.

## €uros



**PRICE INCREASE FOR POWDER COATED, POLISHED ALUMINIUM BASE**

**AC033** 92



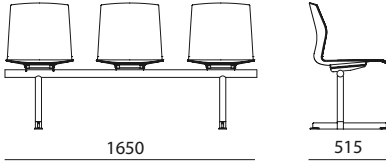

# Kabi Beam

Pensi Design Studio



Beam made of metal structure in round tube of Ø50x3mm powder coated, free standing legs made of tube of Ø40x3mm and 40x10mm steel rim with height adjustable glides. All powder coated.

Seat and back in one piece of 70% Polypropylene + 30% F.G. Supplementary upholstery only on seat or fully upholstered.

- 2 seats  550x480x580mm + 1380x210x560mm
- 3 seats  550x480x580mm + 1580x210x560mm
- 4 seats  550x480x580mm + 2100x210x560mm

## DRAWING

## SPECIFICATION

## REF.

## Euros



### Two Seats

**NON UPHOLSTERED** Polypropylene

**KB19/P** 820

**SEAT UPHOLSTERED** Group D

**KB19/D** 985

**SEAT UPHOLSTERED** Group C & COF

**KB19/C** 994

**SEAT UPHOLSTERED** Group B & Valencia

**KB19/B** 1.017

**SEAT UPHOLSTERED** Group A & COL

**KB19/A** 1.052

**SEAT UPHOLSTERED** Soft leather

**KB19/L** 1.143

**FULLY UPHOLSTERED** Group D

**KB22/D** 1.024

**FULLY UPHOLSTERED** Group C & COF

**KB22/C** 1.065

**FULLY UPHOLSTERED** Group B & Valencia

**KB22/B** 1.116

**FULLY UPHOLSTERED** Group A & COL

**KB22/A** 1.244

**FULLY UPHOLSTERED** Soft leather

**KB22/L** 1.523

### Three Seats

**NON UPHOLSTERED** Polypropylene

**KB20/P** 985

**SEAT UPHOLSTERED** Group D

**KB20/D** 1.230

**SEAT UPHOLSTERED** Group C & COF

**KB20/C** 1.244

**SEAT UPHOLSTERED** Group B & Valencia

**KB20/B** 1.281

**SEAT UPHOLSTERED** Group A & COL

**KB20/A** 1.331

**SEAT UPHOLSTERED** Soft leather

**KB20/L** 1.466

**FULLY UPHOLSTERED** Group D

**KB23/D** 1.292

**FULLY UPHOLSTERED** Group C & COF

**KB23/C** 1.352

**FULLY UPHOLSTERED** Group B & Valencia

**KB23/B** 1.427

**FULLY UPHOLSTERED** Group A & COL

**KB23/A** 1.617

**FULLY UPHOLSTERED** Soft leather

**KB23/L** 2.039

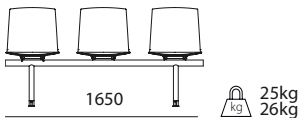



Measure: Only seat 0,55m/3 feet. Measure: Fully upholstered 0,86m/15 feet. For projects, please contact the factory.

# Kabi Beam

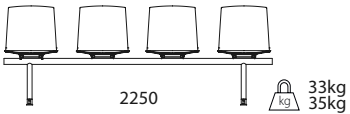
Pensi Design Studio

DRAWING	SPECIFICATION	REF.	Euros
	<p><u>Four Seats</u></p> <p><b>NON UPHOLSTERED</b> Polypropylene</p> <p><b>SEAT UPHOLSTERED</b> Group D</p> <p><b>SEAT UPHOLSTERED</b> Group C &amp; COF</p> <p><b>SEAT UPHOLSTERED</b> Group B &amp; Valencia</p> <p><b>SEAT UPHOLSTERED</b> Group A &amp; COL</p> <p><b>SEAT UPHOLSTERED</b> Soft leather</p> <p><b>FULLY UPHOLSTERED</b> Group D</p> <p><b>FULLY UPHOLSTERED</b> Group C &amp; COF</p> <p><b>FULLY UPHOLSTERED</b> Group B &amp; Valencia</p> <p><b>FULLY UPHOLSTERED</b> Group A &amp; COL</p> <p><b>FULLY UPHOLSTERED</b> Soft leather</p>	<p><b>KB21/P</b></p> <p><b>KB21/D</b></p> <p><b>KB21/C</b></p> <p><b>KB21/B</b></p> <p><b>KB21/A</b></p> <p><b>KB21/L</b></p> <p><b>KB24/D</b></p> <p><b>KB24/C</b></p> <p><b>KB24/B</b></p> <p><b>KB24/A</b></p> <p><b>KB24/L</b></p>	<p>1.148</p> <p>1.475</p> <p>1.494</p> <p>1.542</p> <p>1.608</p> <p>1.791</p> <p>1.555</p> <p>1.638</p> <p>1.739</p> <p>1.993</p> <p>2.552</p>
	<p>Measure: Only seat 0,55m/3 feet. Measure: Fully upholstered 0,86m/15 feet. For projects, please contact the factory.</p>		

## ACCESSORIES

DRAWING	SPECIFICATION	REF.	Euros
	<p><b>PRICE INCREASE CLOSED ARMS POWDER COATED</b> (per one seat)</p>	<b>AC031</b>	92
	<p><b>PRICE INCREASE CLOSED ARMS CHROMED</b> (per one seat)</p>	<b>AC032</b>	142
	<p><b>LINKING DEVICE BETWEEN BEAMS WITHOUT ARMS</b></p>	<b>AC035</b>	104
	<p><b>LINKING DEVICE BETWEEN BEAMS WITH ARMS</b></p>	<b>AC036</b>	104
	<p><b>PRICE INCREASE TABLE</b> Compact white or black 13mm (*)</p> <p>(*) PLEASE SPECIFY THE POSITION OF THE SEAT.</p>	<b>AC037</b>	266

---

# *Kabi Kids*

Pensi Design Studio



Kabi means “nest” in our Basque language. Just sit on this chair and you’ll see why it gets its name. It’s that place that cuddles you, protects you and makes you feel good. It doesn’t take much to make you feel this comfortable. That’s the key to the small pleasures. And that’s the key to Kabi: maximum sensations with minimum resources.

The new Kabi Kids collection serves to expand the Kabi programme. With more compact seating which nonetheless maintains the characteristic comfortable, single-body design. The family presents a 4 legs structure, with four different heights and all of them stackable.

# Kabi Kids

Pensi Design Studio

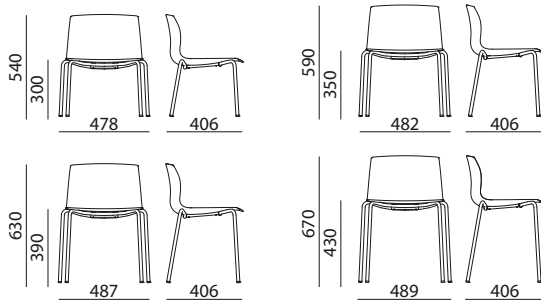

Size 2	670x570x760mm	4 units	10 units	Size 4	670x570x860mm	4 units	10 units
Size 3	670x570x760mm	4 units	10 units	Size 5	670x570x860mm	4 units	10 units

Stackable children's chair available in 4 heights. Frame made of steel of Ø16mm powder coated.

Seat and back in one piece of polypropylene 80% + 20% F.G.

Polypropylene glides, felt glides with price increase.

## DRAWING

## SPECIFICATION

## REF.

## €uros

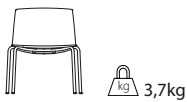

### Size 2 (3-4 children)

**NON UPHOLSTERED** Polypropylene  
Seat height 300mm

**KB80/D**

145

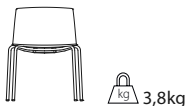

### Size 3 (5-7 children)

**NON UPHOLSTERED** Polypropylene  
Seat height 350mm

**KB81/D**

145

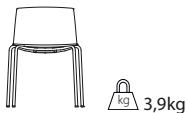

### Size 4 (8-9 children)

**NON UPHOLSTERED** Polypropylene  
Seat height 390mm

**KB82/D**

145

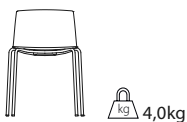

### Size 5 (10-12 children)

**NON UPHOLSTERED** Polypropylene  
Seat height 430mm

**KB83/D**

145

## ACCESSORIES

## DRAWING

## SPECIFICATION

## REF.

## €uros



**PRICE INCREASE FOR FELT** (per chair)

**ACT1**

10

---

# *Kabi Stool*

Pensi Design Studio



The new Kabi Stool collection serves to expand the Kabi programme. With more compact seating which nonetheless maintains the characteristic comfortable, single-body design, offering different base options for a range of spaces. It is also available in two heights: a higher barstool and a medium-height stool for counters, in both private and public settings.

The product family features four different bases, including a 4-legged stacking option. All these variants combine with the Kabi single-body structure, in polypropylene or with fabric upholstery, and an endless array of finishes and colours. All of which goes to create an extensive and consistent collection, to resolve the different needs of the Hospitality and Contract market.

# Kabi Stool 4 Legs

Pensi Design Studio

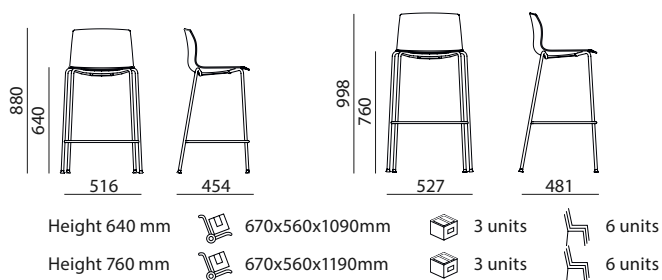

Stackable stool available in 2 heights. Frame made of steel of Ø16mm powder coated.

Seat and back in one piece of polypropylene 80% + 20% F.G.

Polypropylene glides, felt glides with price increase.

## DRAWING

## SPECIFICATION

## REF.

## €uros



### Height 640mm

- NON UPHOLSTERED** Polypropylene
- SEAT UPHOLSTERED** Group D
- SEAT UPHOLSTERED** Group C & COF
- SEAT UPHOLSTERED** Group B & Valencia
- SEAT UPHOLSTERED** Group A & COL
- SEAT UPHOLSTERED** Soft leather
- FULLY UPHOLSTERED** Group D
- FULLY UPHOLSTERED** Group C & COF
- FULLY UPHOLSTERED** Group B & Valencia
- FULLY UPHOLSTERED** Group A & COL
- FULLY UPHOLSTERED** Soft leather

<b>KB50/P</b>	211
<b>KB70/D</b>	264
<b>KB70/C</b>	271
<b>KB70/B</b>	289
<b>KB70/A</b>	317
<b>KB70/L</b>	330
<b>KB50/D</b>	307
<b>KB50/C</b>	328
<b>KB50/B</b>	351
<b>KB50/A</b>	410
<b>KB50/L</b>	541

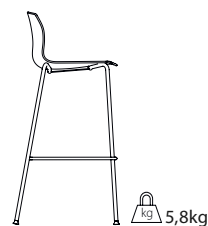

### Height 760mm

- NON UPHOLSTERED** Polypropylene
- SEAT UPHOLSTERED** Group D
- SEAT UPHOLSTERED** Group C & COF
- SEAT UPHOLSTERED** Group B & Valencia
- SEAT UPHOLSTERED** Group A & COL
- SEAT UPHOLSTERED** Soft leather
- FULLY UPHOLSTERED** Group D
- FULLY UPHOLSTERED** Group C & COF
- FULLY UPHOLSTERED** Group B & Valencia
- FULLY UPHOLSTERED** Group A & COL
- FULLY UPHOLSTERED** Soft leather

<b>KB51/P</b>	218
<b>KB71/D</b>	268
<b>KB71/C</b>	275
<b>KB71/B</b>	294
<b>KB71/A</b>	321
<b>KB71/L</b>	337
<b>KB51/D</b>	314
<b>KB51/C</b>	333
<b>KB51/B</b>	355
<b>KB51/A</b>	415
<b>KB51/L</b>	546

Measure: fabric 0,60ml/leather 12 feet. For projects, please contact the factory.

## ACCESSORIES

## DRAWING

## SPECIFICATION

## REF.

## €uros







**PRICE INCREASE FOR FELT** (per chair)

<b>ACT1</b>	10
-------------	----

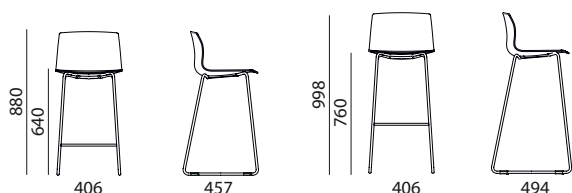
# Kabi Stool Sled

Pensi Design Studio



Height 640 mm  540x540x970mm  1 unit  
 Height 760 mm  540x540x1090mm  1 unit

Sled frame stool available in 2 heights. Frame made of steel of Ø14mm powder coated and with translucent glides.

Seat and back in one piece of polypropylene 80% + 20% F.G.

Option translucent glides with felt with price increase.

## DRAWING

## SPECIFICATION

## REF.

## €uros



### Height 640mm

- NON UPHOLSTERED** Polypropylene
- SEAT UPHOLSTERED** Group D
- SEAT UPHOLSTERED** Group C & COF
- SEAT UPHOLSTERED** Group B & Valencia
- SEAT UPHOLSTERED** Group A & COL
- SEAT UPHOLSTERED** Soft leather
- FULLY UPHOLSTERED** Group D
- FULLY UPHOLSTERED** Group C & COF
- FULLY UPHOLSTERED** Group B & Valencia
- FULLY UPHOLSTERED** Group A & COL
- FULLY UPHOLSTERED** Soft leather

<b>KB52/P</b>	204
<b>KB72/D</b>	255
<b>KB72/C</b>	264
<b>KB72/B</b>	280
<b>KB72/A</b>	307
<b>KB72/L</b>	323
<b>KB52/D</b>	300
<b>KB52/C</b>	321
<b>KB52/B</b>	344
<b>KB52/A</b>	404
<b>KB52/L</b>	534

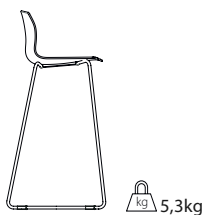

### Height 760mm

- NON UPHOLSTERED** Polypropylene
- SEAT UPHOLSTERED** Group D
- SEAT UPHOLSTERED** Group C & COF
- SEAT UPHOLSTERED** Group B & Valencia
- SEAT UPHOLSTERED** Group A & COL
- SEAT UPHOLSTERED** Soft leather
- FULLY UPHOLSTERED** Group D
- FULLY UPHOLSTERED** Group C & COF
- FULLY UPHOLSTERED** Group B & Valencia
- FULLY UPHOLSTERED** Group A & COL
- FULLY UPHOLSTERED** Soft leather

<b>KB53/P</b>	213
<b>KB73/D</b>	264
<b>KB73/C</b>	271
<b>KB73/B</b>	289
<b>KB73/A</b>	317
<b>KB73/L</b>	333
<b>KB53/D</b>	310
<b>KB53/C</b>	328
<b>KB53/B</b>	351
<b>KB53/A</b>	410
<b>KB53/L</b>	541

Measure: fabric 0,60ml/leather 12 feet. For projects, please contact the factory.

## ACCESSORIES

## DRAWING

## SPECIFICATION

## REF.

## €uros



**PRICE INCREASE FOR FELT** (per chair)

**AC041**

13

# Kabi Stool Pyramid

Pensi Design Studio

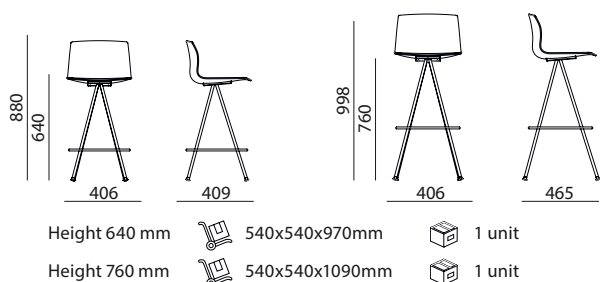

Pyramid fixed frame stool available in 2 heights. Frame made of steel tube Ø16mm with footrest powder coated.

Seat and back in one piece of polypropylene 80% + 20% F.G.

Polypropylene glides, option for felt with a price increase.

## DRAWING

## SPECIFICATION

## REF.

## €uros



### Height 640mm

- NON UPHOLSTERED** Polypropylene
- SEAT UPHOLSTERED** Group D
- SEAT UPHOLSTERED** Group C & COF
- SEAT UPHOLSTERED** Group B & Valencia
- SEAT UPHOLSTERED** Group A & COL
- SEAT UPHOLSTERED** Soft leather
- FULLY UPHOLSTERED** Group D
- FULLY UPHOLSTERED** Group C & COF
- FULLY UPHOLSTERED** Group B & Valencia
- FULLY UPHOLSTERED** Group A & COL
- FULLY UPHOLSTERED** Soft leather

<b>KB54/P</b>	220
<b>KB74/D</b>	271
<b>KB74/C</b>	278
<b>KB74/B</b>	296
<b>KB74/A</b>	323
<b>KB74/L</b>	339
<b>KB54/D</b>	317
<b>KB54/C</b>	337
<b>KB54/B</b>	360
<b>KB54/A</b>	420
<b>KB54/L</b>	550



### Height 760mm

- NON UPHOLSTERED** Polypropylene
- SEAT UPHOLSTERED** Group D
- SEAT UPHOLSTERED** Group C & COF
- SEAT UPHOLSTERED** Group B & Valencia
- SEAT UPHOLSTERED** Group A & COL
- SEAT UPHOLSTERED** Soft leather
- FULLY UPHOLSTERED** Group D
- FULLY UPHOLSTERED** Group C & COF
- FULLY UPHOLSTERED** Group B & Valencia
- FULLY UPHOLSTERED** Group A & COL
- FULLY UPHOLSTERED** Soft leather

<b>KB55/P</b>	225
<b>KB75/D</b>	278
<b>KB75/C</b>	284
<b>KB75/B</b>	303
<b>KB75/A</b>	330
<b>KB75/L</b>	346
<b>KB55/D</b>	321
<b>KB55/C</b>	339
<b>KB55/B</b>	362
<b>KB55/A</b>	422
<b>KB55/L</b>	552

Measure: fabric 0,60ml/leather 12 feet. For projects, please contact the factory.

## ACCESSORIES

## DRAWING

## SPECIFICATION

## REF.

## €uros



**PRICE INCREASE FOR FELT** (per chair)



<b>AC015</b>	10
--------------	----



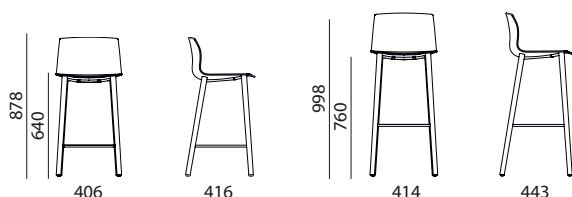

# Kabi Stool Wood Legs

Pensi Design Studio



Height 640 mm  540x540x970mm  1 unit

Height 760 mm  540x540x1090mm  1 unit

Stool with four beech wood legs non-stackable available in 2 heights. Frame made of steel tube and natural stained wood legs with chromed footrest. For other stained colours, please contact the factory.

Seat and back in one piece of polypropylene 80% + 20% F.G.

Polypropylene glides, option for felt with a price increase.

## DRAWING

## SPECIFICATION

## REF.

## €uros

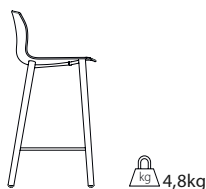

### Height 640mm

**NON UPHOLSTERED** Polypropylene

**KB56/P** 378

**SEAT UPHOLSTERED** Group D

**KB76/D** 429

**SEAT UPHOLSTERED** Group C & COF

**KB76/C** 436

**SEAT UPHOLSTERED** Group B & Valencia

**KB76/B** 454

**SEAT UPHOLSTERED** Group A & COL

**KB76/A** 481

**SEAT UPHOLSTERED** Soft leather

**KB76/L** 497

**FULLY UPHOLSTERED** Group D

**KB56/D** 475

**FULLY UPHOLSTERED** Group C & COF

**KB56/C** 495

**FULLY UPHOLSTERED** Group B & Valencia

**KB56/B** 518

**FULLY UPHOLSTERED** Group A & COL

**KB56/A** 578

**FULLY UPHOLSTERED** Soft leather

**KB56/L** 708

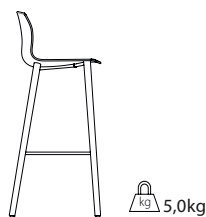

### Height 760mm

**NON UPHOLSTERED** Polypropylene

**KB57/P** 383

**SEAT UPHOLSTERED** Group D

**KB77/D** 433

**SEAT UPHOLSTERED** Group C & COF

**KB77/C** 442

**SEAT UPHOLSTERED** Group B & Valencia

**KB77/B** 458

**SEAT UPHOLSTERED** Group A & COL

**KB77/A** 486

**SEAT UPHOLSTERED** Soft leather

**KB77/L** 502

**FULLY UPHOLSTERED** Group D

**KB57/D** 479

**FULLY UPHOLSTERED** Group C & COF

**KB57/C** 500

**FULLY UPHOLSTERED** Group B & Valencia

**KB57/B** 523

**FULLY UPHOLSTERED** Group A & COL

**KB57/A** 582

**FULLY UPHOLSTERED** Soft leather

**KB57/L** 713

NOTE: FOR OTHER STAINED COLOURS, ASK THE FACTORY FOR A MINIMUM LOT AND A SUPPLEMENT IN PRICE. Measure: fabric 0,60ml/leather 12 feet. For projects, please contact the factory.

## ACCESSORIES

## DRAWING

## SPECIFICATION

## REF.

## €uros



**PRICE INCREASE FOR FELT** (per chair)

**ACM1**

12

---

# *Kabi Armchair*

Pensi Design Studio



Kabi Armchair is an armchair that is born from its more technical aspect due to its resistance to become a cozy armchair with upholstered arms without losing its essence. Like the Kabi collection, it comes in all its variants, with office base, sled, pyramid, wood and 4 legs with a variety of upholstery options providing a multitude of combinations.

# Kabi Armchair

Pensi Design Studio

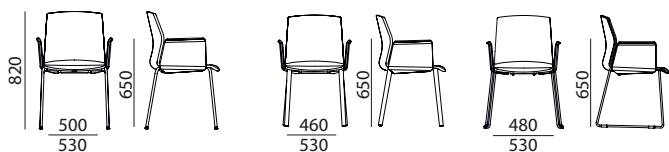

Kabi 4 Legs		590x670x1150mm		2 units
Kabi Wood Legs		590x670x1150mm		2 units
Kabi Sled		590x670x1150mm		2 units

Non-stackable armchair with upholstered arms. Versions; 4 painted or chromed Ø16mm tube legs with supplement, wooden legs, painted or chromed Ø14mm steel sled with supplement.

Seat and back in one piece of 70% Polypropylene + 30% F.G. Fully upholstered with curved plywood arms, upholstered in fabric or soft leather.

## DRAWING

## SPECIFICATION

## REF.

## €uros

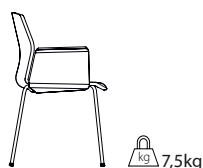

### Kabi 4 Legs

- FULLY UPHOLSTERED** Group D
- FULLY UPHOLSTERED** Group C & COF
- FULLY UPHOLSTERED** Group B & Valencia
- FULLY UPHOLSTERED** Group A & COL
- FULLY UPHOLSTERED** Soft leather
- FELT SUPPLEMENT**
- CHROME SUPPLEMENT**

<b>KB35/D</b>	420
<b>KB35/C</b>	463
<b>KB35/B</b>	529
<b>KB35/A</b>	626
<b>KB35/L</b>	779
<b>AC015</b>	10
	46

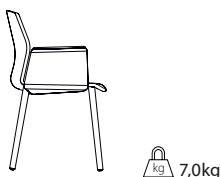

### Kabi Wood Legs

- FULLY UPHOLSTERED** Group D
- FULLY UPHOLSTERED** Group C & COF
- FULLY UPHOLSTERED** Group B & Valencia
- FULLY UPHOLSTERED** Group A & COL
- FULLY UPHOLSTERED** Soft leather
- FELT SUPPLEMENT**

<b>KB36/D</b>	566
<b>KB36/C</b>	612
<b>KB36/B</b>	676
<b>KB36/A</b>	772
<b>KB36/L</b>	926
<b>ACM1</b>	12

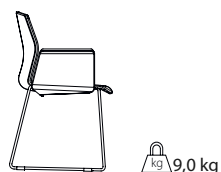

### Kabi Sled





- FULLY UPHOLSTERED** Group D
- FULLY UPHOLSTERED** Group C & COF
- FULLY UPHOLSTERED** Group B & Valencia
- FULLY UPHOLSTERED** Group A & COL
- FULLY UPHOLSTERED** Soft leather
- FELT SUPPLEMENT**
- CHROME SUPPLEMENT**

<b>KB37/D</b>	442
<b>KB37/C</b>	486
<b>KB37/B</b>	552
<b>KB37/A</b>	649
<b>KB37/L</b>	802
<b>AC041</b>	13
	37

# Kabi Armchair

Pensi Design Studio



Kabi Pyramid  590x670x1150mm  2 units  
 Kabi Office  630x630x580mm  1 unit

Non-stackable armchair with upholstered arms. Versions; pyramidal with base of 4 legs of injected aluminium, painted or polished with option of castors and base office with 5 supports in polyamide, polished or painted aluminium with castors and height-adjustable.

Seat and back in one piece of 70% Polypropylene + 30% F.G. Fully upholstered with curved plywood arms, upholstered in fabric or soft leather.

## DRAWING

## SPECIFICATION

## REF.

## €uros

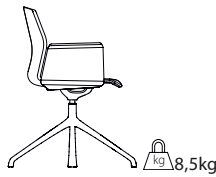

### Kabi Swivel

**FULLY UPHOLSTERED** Group D

**KB38/D** 642

**FULLY UPHOLSTERED** Group C & COF

**KB38/C** 687

**FULLY UPHOLSTERED** Group B & Valencia

**KB38/B** 752

**FULLY UPHOLSTERED** Group A & COL

**KB38/A** 848

**FULLY UPHOLSTERED** Soft leather

**KB38/L** 1.001

**FELT SUPPLEMENT**

**AC039** 19

**CASTORS SUPPLEMENT**

**AC030** 23

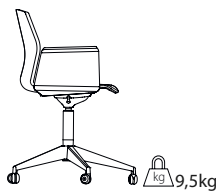

### Kabi Office

**FULLY UPHOLSTERED** Group D

**KB39/D** 635

**FULLY UPHOLSTERED** Group C & COF

**KB39/C** 681

**FULLY UPHOLSTERED** Group B & Valencia

**KB39/B** 745

**FULLY UPHOLSTERED** Group A & COL

**KB39/A** 841

**FULLY UPHOLSTERED** Soft leather

**KB39/L** 994

**PAINTED OR POLISHED ALUMINUM BASE SUPPLEMENT**

**AC033** 92

NOTE: SPECIFY HARD OR SOFT CASTORS. IF NOT SPECIFIED, HARD CASTORS WILL BE SENT. BLACK, WHITE OR GREY POLYAMIDE BASE.

Measure: Arms upholstered 1,40/ 22 feet. For projects, please contact the factory.

---

# Gorka

Pensi Design Studio



Gorka has been and is the essence of Akaba: our best seller. Designed by Jorge Pensi, this is a chair capable of creating an atmosphere in all kinds of interior decoration projects. A chair of high design, ergonomic and customizable. Perfect for contract, office and home use, Gorka is an ideal model for projects requiring an ergonomic chair of high design. In its structure, gentle lines subtly combine, framed by the aluminium of its sides and legs. Classic elegance, timeless design.

Gorka comes in 3 versions adapted to the needs of each space: Gorka, Gorka XL and Gorka Lounge.

# Gorka Polyamide

Pensi Design Studio

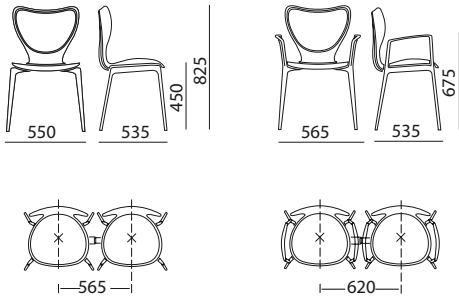

610x730x1080mm 4 units 10 units

Stackable chair, without or with arms, or with only one arm and desk tray.

Frame made of injected aluminium powder coated. Option for polished, chromed with price increase. Seat and back in one piece of polyamide-6.

## DRAWING

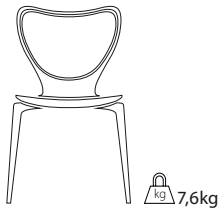

### Without Arms

- NON UPHOLSTERED** Polyamide
- SEAT & BACK UPHOLSTERED** Group D
- SEAT & BACK UPHOLSTERED** Group C & COF
- SEAT & BACK UPHOLSTERED** Group B & Valencia
- SEAT & BACK UPHOLSTERED** Group A & COL
- SEAT & BACK UPHOLSTERED** Soft leather
- POLISHED ALUMINUM SUPPLEMENT**

**REF.**    **€uros**                      **REF.**    **€uros**

Without linking device                      With linking device

<b>261/P</b>	303	<b>331/P</b>	376
<b>261/D</b>	404	<b>331/D</b>	477
<b>261/C</b>	415	<b>331/C</b>	488
<b>261/G</b>	433	<b>331/G</b>	504
<b>261/A</b>	484	<b>331/A</b>	555
<b>261/L</b>	589	<b>331/L</b>	662
	92		92

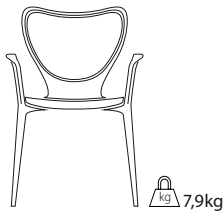

### With Arms

- NON UPHOLSTERED** Polyamide
- SEAT & BACK UPHOLSTERED** Group D
- SEAT & BACK UPHOLSTERED** Group C & COF
- SEAT & BACK UPHOLSTERED** Group B & Valencia
- SEAT & BACK UPHOLSTERED** Group A & COL
- SEAT & BACK UPHOLSTERED** Soft leather
- POLISHED ALUMINUM SUPPLEMENT**

Without linking device                      With linking device





<b>262/P</b>	344	<b>332/P</b>	417
<b>262/D</b>	445	<b>332/D</b>	518
<b>262/C</b>	456	<b>332/C</b>	529
<b>262/G</b>	475	<b>332/G</b>	548
<b>262/A</b>	525	<b>332/A</b>	598
<b>262/L</b>	630	<b>332/L</b>	704
	131		131

Measure: Seat and back 0,54 ml/10 feet. For projects, please contact the factory.

# Gorka Polyamide

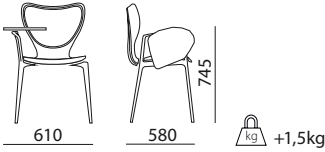
Pensi Design Studio

## ACCESSORIES

DRAWING	SPECIFICATION	REF.	Euros
	<b>DESK TRAY RIGHT</b> (compact black or white) <b>DESK TRAY LEFT</b> (compact black or white)	<b>263/D</b> <b>263/I</b>	145 145
	ATTENTION TO ADD THE DESK TRAY IT IS NECESSARY TO ASSEMBLE ONE ARM.		
	<b>TRANSPORT AND STORAGE TROLLEY</b> (powder coated) 14 units	<b>AC016</b>	367
	<b>DOCUMENT CONTAINER</b> (chromed)	<b>266/A</b>	74
	<b>PRICE INCREASE FOR FELT</b> (per chair)	<b>270/A</b>	14



# Gorka Wood

Pensi Design Studio

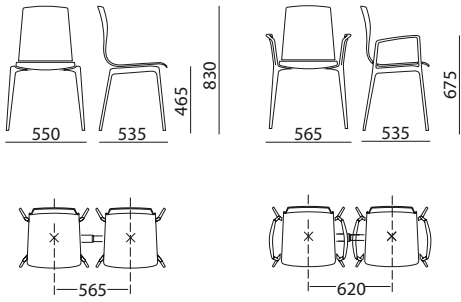

610x730x1080mm 4 units 10 units

Stackable chair, without or with arms, or with only one arm and desk tray.

Frame made of injected aluminium powder coated. Option for polished, chromed with price increase. Seat and back in one piece of beech veneer varnished, laminate or upholstered or fully upholstered.

## DRAWING

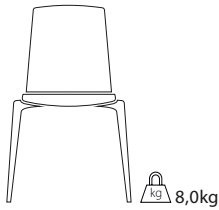

## SPECIFICATION

### Without Arms

- NON UPHOLSTERED** Wood
- FULLY UPHOLSTERED** Group D
- FULLY UPHOLSTERED** Group C & COF
- FULLY UPHOLSTERED** Group B & Valencia
- FULLY UPHOLSTERED** Group A & COL
- FULLY UPHOLSTERED** Hide
- FULLY UPHOLSTERED** Soft leather
- POLISHED ALUMINUM SUPPLEMENT**

**REF.**    **€uros**                      **REF.**    **€uros**

	Without linking device	With linking device
<b>256/M</b>	365	<b>346/M</b> 438
<b>256/D</b>	406	<b>346/D</b> 481
<b>256/Z</b>	429	<b>346/Z</b> 502
<b>256/X</b>	452	<b>346/X</b> 525
<b>256/W</b>	502	<b>346/W</b> 575
<b>256/H</b>	548	<b>346/H</b> 621
<b>256/S</b>	633	<b>346/S</b> 706
	92	92

### With Arms

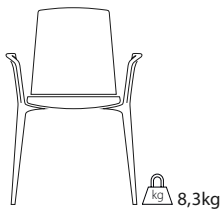

- NON UPHOLSTERED** Wood
- FULLY UPHOLSTERED** Group D
- FULLY UPHOLSTERED** Group C & COF
- FULLY UPHOLSTERED** Group B & Valencia
- FULLY UPHOLSTERED** Group A & COL
- FULLY UPHOLSTERED** Hide
- FULLY UPHOLSTERED** Soft leather
- POLISHED ALUMINUM SUPPLEMENT**

	Without linking device	With linking device
<b>257/M</b>	406	<b>347/M</b> 479
<b>257/D</b>	449	<b>347/D</b> 520
<b>257/Z</b>	472	<b>347/Z</b> 543
<b>257/X</b>	495	<b>347/X</b> 566
<b>257/W</b>	546	<b>347/W</b> 617
<b>257/H</b>	591	<b>347/H</b> 662
<b>257/S</b>	676	<b>347/S</b> 747
	131	131





Measure: Fully upholstered 0,87 ml/15 feet. For projects, please contact the factory.

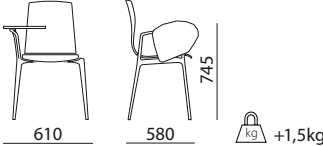

# Gorka Wood

Pensi Design Studio

## ACCESSORIES

DRAWING	SPECIFICATION	REF.	Euros
	<b>DESK TRAY RIGHT</b> (compact black or white)	<b>263/D</b>	145
	<b>DESK TRAY LEFT</b> (compact black or white)	<b>263/I</b>	145
	ATTENTION TO ADD THE DESK TRAY IT IS NECESSARY TO ASSEMBLE ONE ARM.		
	<b>TRANSPORT AND STORAGE TROLLEY</b> (powder coated) 14 units	<b>AC016</b>	367
	<b>DOCUMENT CONTAINER</b> (chromed)	<b>266/A</b>	74
	<b>PRICE INCREASE FOR FELT</b> (per chair)	<b>270/A</b>	14

# Gorka XL Wood

Pensi Design Studio

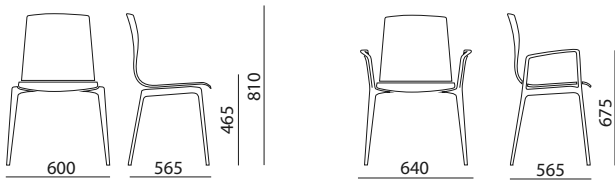

610x730x1080mm 3 units 10 units

Stackable chair with or without arms.

Frame made of injected aluminium powder coated. Option for polished with price increase. Seat and back in one piece of beech veneer varnished, laminate or upholstered. Supplementary front upholstery on seat and back.

## DRAWING

## SPECIFICATION

## REF.

## €uros

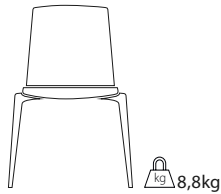

### Without Arms

- NON UPHOLSTERED** Wood
- FULLY UPHOLSTERED** Group D
- FULLY UPHOLSTERED** Group C & COF
- FULLY UPHOLSTERED** Group B & Valencia
- FULLY UPHOLSTERED** Group A & COL
- FULLY UPHOLSTERED** Hide
- FULLY UPHOLSTERED** Soft leather
- POLISHED ALUMINUM SUPPLEMENT**

<b>215/M</b>	429
<b>215/D</b>	481
<b>215/Z</b>	502
<b>215/X</b>	539
<b>215/W</b>	600
<b>215/H</b>	667
<b>215/S</b>	768
	99

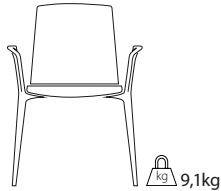

### With Arms

- NON UPHOLSTERED** Wood
- FULLY UPHOLSTERED** Group D
- FULLY UPHOLSTERED** Group C & COF
- FULLY UPHOLSTERED** Group B & Valencia
- FULLY UPHOLSTERED** Group A & COL
- FULLY UPHOLSTERED** Hide
- FULLY UPHOLSTERED** Soft leather
- POLISHED ALUMINUM SUPPLEMENT**

<b>216/M</b>	472
<b>216/D</b>	523
<b>216/Z</b>	543
<b>216/X</b>	580
<b>216/W</b>	642
<b>216/H</b>	701
<b>216/S</b>	811
	133

Measure: Fully upholstered 0,92 ml/18 feet. For projects, please contact the factory.

## ACCESSORIES

## DRAWING

## SPECIFICATION

## REF.

## €uros



- PRICE INCREASE FOR FELT** (per chair)

<b>270/A</b>	14
--------------	----

# Gorka XL Swivel

Pensi Design Studio

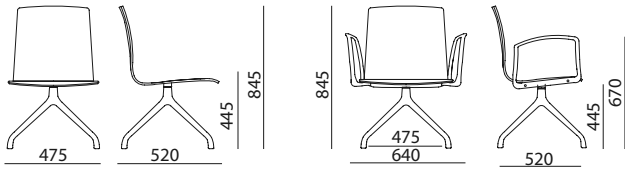

610x730x1080mm unit

Chair with or without arms. Swivel frame made of polished, powder coated injected aluminium.

Aluminium arms powder coated, polished. Seat and back in one piece of beech veneer varnished or upholstered.

## DRAWING

## SPECIFICATION

## REF.

## €uros

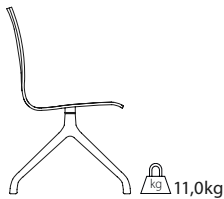

### Without Arms

**NON UPHOLSTERED** Wood

**026/M** 438

**FULLY UPHOLSTERED** Group D

**026/D** 491

**FULLY UPHOLSTERED** Group C & COF

**026/Z** 513

**FULLY UPHOLSTERED** Group B & Valencia

**026/X** 548

**FULLY UPHOLSTERED** Group A & COL

**026/W** 610

**FULLY UPHOLSTERED** Hide

**026/H** 678

**FULLY UPHOLSTERED** Soft leather

**026/S** 777

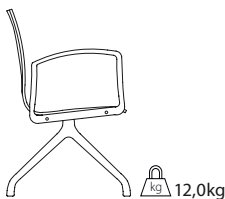

### With Arms

**NON UPHOLSTERED** Wood

**027/M** 633

**FULLY UPHOLSTERED** Group D

**027/D** 683

**FULLY UPHOLSTERED** Group C & COF

**027/Z** 708

**FULLY UPHOLSTERED** Group B & Valencia

**027/X** 742

**FULLY UPHOLSTERED** Group A & COL

**027/W** 804

**FULLY UPHOLSTERED** Hide

**027/H** 871

**FULLY UPHOLSTERED** Soft leather

**027/S** 971

**POLISHED ALUMINIUM ARMS SUPPLEMENT**

83

Measure: Fully upholstered 0,92 ml/18 feet. For projects, please contact the factory.

## ACCESSORIES

## DRAWING

## SPECIFICATION

## REF.

## €uros



**PRICE INCREASE FOR FELT** (per chair)

**AC039** 19



**CASTORS SUPPLEMENT** (per chair)

**AC030** 23

# Gorka Wire Lounge

Pensi Design Studio

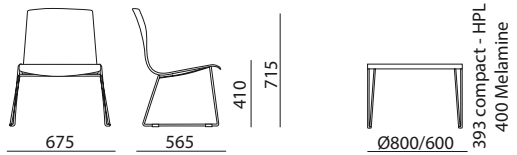

Chair without arms. Frame made of powder coated steel tube of diameter Ø12mm. Option chromed with price increase. Seat and back in one piece of veneer beechwood varnished or upholstered in fabric soft leather hide.

Table frame of wire diameter Ø12mm powder coated. Option chromed with price increase. Table top in compact - HPL or melamine.

810x690x945mm 3 units

## DRAWING

## SPECIFICATION

## REF.

## €uros

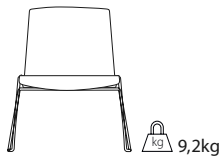

### Gorka Wire Lounge

**NON UPHOLSTERED** Wood

**400/M** 388

**FULLY UPHOLSTERED** Group D

**400/D** 452

**FULLY UPHOLSTERED** Group C & COF

**400/Z** 477

**FULLY UPHOLSTERED** Group B & Valencia

**400/X** 497

**FULLY UPHOLSTERED** Group A & COL

**400/W** 562

**FULLY UPHOLSTERED** Hide

**400/H** 626

**FULLY UPHOLSTERED** Soft leather

**400/S** 726

**CHROME SUPPLEMENT**

33

## DRAWING

## MEASURES mm

## REF.

## €uros

## REF.

## €uros

## €uros



### Round Table

H 399/400mm 11-15kg  
Ø800mm

Melamine 20mm

Compact - HPL

Chrome supplement

**402/M** 266

**402/K** 484

31

### Square Table

H 399/400mm 11-15kg  
600x600mm

Melamine 20mm

Compact - HPL

Chrome supplement

**403/M** 200

**403/K** 333

35

---

# Branka

Pensi Design Studio



A versatile chair, easy and strong, made to withstand everyday contract wear and use. Meet Branka, meaning “bow” in Basque. Ships have always set sail from our territory with their bow pointing towards the immensity of the seas, strong and inexorable, unstoppable by any obstacles. This tribute to our marine past and present, to the bravery and hardiness of our “arrantzales” (fishermen and women), is represented in Branka.

A chair capable of meeting any challenges thrown at it: with tremendously strong joints, and with a resistance and durability that can withstand (almost) anything. And yet also easy to assemble, easy to manufacture and easy to upholster. A chair with our complete DNA which, immediately it was created, comfortably entered the Akaba catalogue, with elegance and reliability.

# Branka Polypropylene

Pensi Design Studio

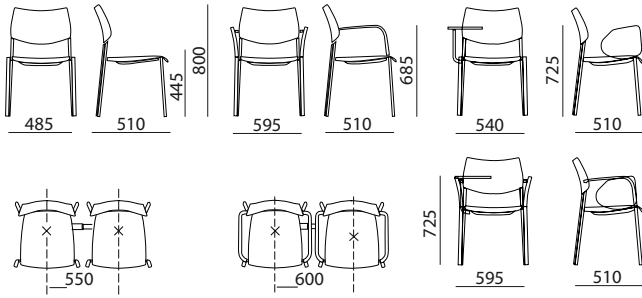

610x730x1080mm 4 units 10 units

Stackable chair with or without arms in Polyamide or painted aluminium.

Structure in steel powder coated, with option for chromed/polish with price increase. Seat and back in polypropylene non-upholstered or upholstered.

## DRAWING

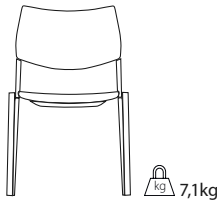

### Without Arms

- NON UPHOLSTERED** Polypropylene
- SEAT & BACK UPHOLSTERED** Group D
- SEAT & BACK UPHOLSTERED** Group C & COF
- SEAT & BACK UPHOLSTERED** Group B & Valencia
- SEAT & BACK UPHOLSTERED** Grupo A
- SEAT & BACK UPHOLSTERED** Hide
- CHROME/POLISH SUPPLEMENT**

## REF.    Euros    REF.    Euros

Without linking device		With linking device	
<b>780/P</b>	191	<b>781/P</b>	234
<b>780/D</b>	319	<b>781/D</b>	362
<b>780/C</b>	342	<b>781/C</b>	385
<b>780/B</b>	371	<b>781/B</b>	417
<b>780/A</b>	422	<b>781/A</b>	465
<b>780/H</b>	532	<b>781/H</b>	575
	53		53

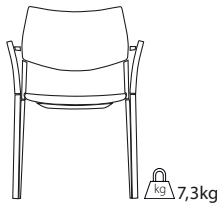

### With Arms Polyamide

- NON UPHOLSTERED** Polypropylene
- SEAT & BACK UPHOLSTERED** Group D
- SEAT & BACK UPHOLSTERED** Group C & COF
- SEAT & BACK UPHOLSTERED** Group B & Valencia
- SEAT & BACK UPHOLSTERED** Grupo A
- SEAT & BACK UPHOLSTERED** Hide
- CHROME/POLISH SUPPLEMENT**

Without linking device		With linking device	
<b>782/P</b>	243	<b>783/P</b>	289
<b>782/D</b>	371	<b>783/D</b>	417
<b>782/C</b>	394	<b>783/C</b>	440
<b>782/B</b>	424	<b>783/B</b>	470
<b>782/A</b>	477	<b>783/A</b>	523
<b>782/H</b>	582	<b>783/H</b>	630
	53		53

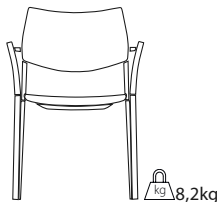

### With Arms Aluminium Powder coated

- NON UPHOLSTERED** Polypropylene
- SEAT & BACK UPHOLSTERED** Group D
- SEAT & BACK UPHOLSTERED** Group C & COF
- SEAT & BACK UPHOLSTERED** Group B & Valencia
- SEAT & BACK UPHOLSTERED** Grupo A
- SEAT & BACK UPHOLSTERED** Hide
- CHROME/POLISH SUPPLEMENT**





Without linking device		With linking device	
<b>784/P</b>	273	<b>785/P</b>	317
<b>784/D</b>	401	<b>785/D</b>	447
<b>784/C</b>	424	<b>785/C</b>	470
<b>784/B</b>	454	<b>785/B</b>	502
<b>784/A</b>	504	<b>785/A</b>	552
<b>784/H</b>	614	<b>785/H</b>	660
	83		83

Measure: Seat and back 0,66 ml/12 feet. For projects, please contact the factory.

# Branka Polypropylene

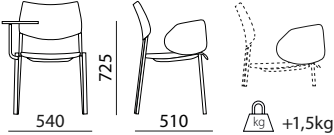
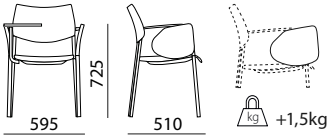
Pensi Design Studio

## ACCESSORIES

DRAWING	SPECIFICATION	REF.	Euros
	<p><b>PRICE INCREASE CHAIR PREPARED FOR DESK TRAY</b> (per chair)</p> <p><b>DESK TRAY FOR CHAIR WITHOUT ARMS RIGHT</b> (compact black or white)</p> <p><b>DESK TRAY FOR CHAIR WITHOUT ARMS LEFT</b> (compact black or white)</p>	<p><b>367/Q</b></p> <p><b>367/D</b></p> <p><b>367/I</b></p>	<p>28</p> <p>122</p> <p>122</p>
	<p><b>PRICE INCREASE CHAIR PREPARED FOR DESK TRAY</b> (per chair)</p> <p><b>DESK TRAY FOR CHAIR WITH ARMS RIGHT</b> (compact black or white)</p> <p><b>DESK TRAY FOR CHAIR WITH ARMS LEFT</b> (compact black or white)</p>	<p><b>367/Q</b></p> <p><b>790/D</b></p> <p><b>790/I</b></p>	<p>28</p> <p>122</p> <p>122</p>
	<p><b>PRICE INCREASE FOR FELT</b> (per chair)</p>	<p><b>795/A</b></p>	<p>14</p>
 	<p><b>TRANSPORT AND STORAGE TROLLEY</b> 760x930mm (powder coated) 14 units</p>	<p><b>796/A</b></p>	<p>456</p>

# Branka Wood

Pensi Design Studio

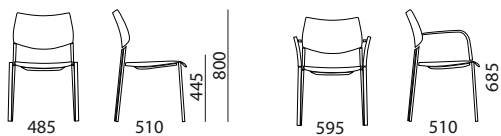

610x730x1080mm 4 units 10 units

Stackable chair with or without arms of aluminium powder coated o polish.

Structure in steel powder coated. Option chromed or polished with price increase.

Seat and back in wood with or without upholstery.

## DRAWING

## SPECIFICATION

REF. Euros REF. Euros

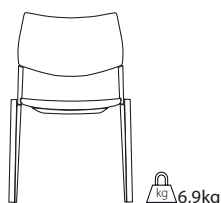

### Without Arms

- NON UPHOLSTERED** Wood
- SEAT UPHOLSTERED** Group D
- SEAT UPHOLSTERED** Group C & COF
- SEAT UPHOLSTERED** Group B & Valencia
- SEAT UPHOLSTERED** Grupo A
- SEAT UPHOLSTERED** Hide
- CHROME/POLISH SUPPLEMENT**

	Without linking device	With linking device
<b>991/M</b>	371	<b>992/M</b> 417
<b>991/D</b>	390	<b>992/D</b> 436
<b>991/Q</b>	404	<b>992/Q</b> 449
<b>991/N</b>	424	<b>992/N</b> 472
<b>991/O</b>	461	<b>992/O</b> 507
<b>991/R</b>	481	<b>992/R</b> 529
	53	53

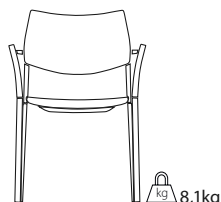

### With Arms Aluminium Powder coated

- NON UPHOLSTERED** Wood
- SEAT UPHOLSTERED** Group D
- SEAT UPHOLSTERED** Group C & COF
- SEAT UPHOLSTERED** Group B & Valencia
- SEAT UPHOLSTERED** Grupo A
- SEAT UPHOLSTERED** Hide
- CHROME/POLISH SUPPLEMENT**

	Without linking device	With linking device
<b>993/M</b>	456	<b>994/M</b> 502
<b>993/D</b>	477	<b>994/D</b> 523
<b>993/Q</b>	491	<b>994/Q</b> 539
<b>993/N</b>	511	<b>994/N</b> 557
<b>993/O</b>	548	<b>994/O</b> 596
<b>993/R</b>	568	<b>994/R</b> 619
	83	83



Measure: Only seat 0,64 ml/11 feet. For projects, please contact the factory.



# Branka Wood

Pensi Design Studio

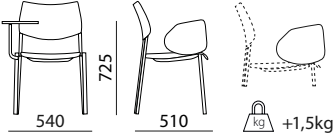
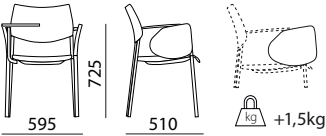
## ACCESSORIES

DRAWING	SPECIFICATION	REF.	Euros
	<p><b>PRICE INCREASE CHAIR PREPARED FOR DESK TRAY</b> (per chair)</p> <p><b>DESK TRAY FOR CHAIR WITHOUT ARMS RIGHT</b> (compact black or white)</p> <p><b>DESK TRAY FOR CHAIR WITHOUT ARMS LEFT</b> (compact black or white)</p>	<p><b>367/Q</b></p> <p><b>367/D</b></p> <p><b>367/I</b></p>	<p>28</p> <p>122</p> <p>122</p>
	<p><b>PRICE INCREASE CHAIR PREPARED FOR DESK TRAY</b> (per chair)</p> <p><b>DESK TRAY FOR CHAIR WITH ARMS RIGHT</b> (compact black or white)</p> <p><b>DESK TRAY FOR CHAIR WITH ARMS LEFT</b> (compact black or white)</p>	<p><b>367/Q</b></p> <p><b>790/D</b></p> <p><b>790/I</b></p>	<p>28</p> <p>122</p> <p>122</p>
	<p><b>PRICE INCREASE FOR FELT</b> (per chair)</p>	<p><b>795/A</b></p>	<p>14</p>
	<p><b>TRANSPORT AND STORAGE TROLLEY</b> 760x930mm (powder coated) 14 units</p>	<p><b>796/A</b></p>	<p>456</p>

---

# Ados

Miguel Ángel Ciganda



We agree: big events must be equipped with furniture capable of providing comfort to exceptional individuals. Of accommodating them... and of attracting them to meeting points.

Ados, from the Basque for being "in agreement", is a line of chairs designed to provide comfort during long talks. Supported by curved lines which, while lending stability, seem to bring those sitting in them closer to one another, encouraging their eyes to meet, their complicity.

This design also maximizes the concept of stackability. Ados is perfect for large projects (multi-purpose rooms, auditoriums and conventions), as well as for medium-sized projects (training and meeting rooms, canteen...).

# Ados

Miguel Ángel Ciganda

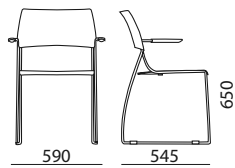
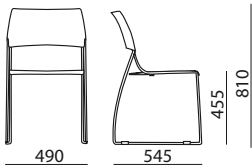

 610x730x1080mm

 4 units

 20 units

Stackable chair with or without arms, frame made of solid wire Ø12mm powder coated or chromed with price increase.

Seat and back in polypropylene. Option supplementary upholstery on the seat and backrest in the front.

Polypropylene glides with felt with price increase.

## DRAWING

## SPECIFICATION

## REF.

€uros

## REF.

€uros

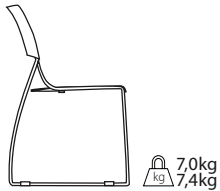

### Without Arms

- NON UPHOLSTERED** Polypropylene
- SEAT UPHOLSTERED** Group D
- SEAT UPHOLSTERED** Group C & COF
- SEAT UPHOLSTERED** Group B & Valencia
- SEAT UPHOLSTERED** Grupo A
- SEAT UPHOLSTERED** Soft leather
- SEAT & BACK UPHOLSTERED** Group D
- SEAT & BACK UPHOLSTERED** Group C & COF
- SEAT & BACK UPHOLSTERED** Group B & Valencia
- SEAT & BACK UPHOLSTERED** Grupo A
- SEAT & BACK UPHOLSTERED** Soft leather

	Powder coated frame	Chromed frame
<b>971/P</b>	220	<b>972/P</b> 255
<b>971/S</b>	307	<b>972/S</b> 342
<b>971/Q</b>	314	<b>972/Q</b> 346
<b>971/N</b>	333	<b>972/N</b> 367
<b>971/O</b>	346	<b>972/O</b> 381
<b>971/R</b>	376	<b>972/R</b> 410
<b>971/D</b>	342	<b>972/D</b> 376
<b>971/C</b>	355	<b>972/C</b> 388
<b>971/B</b>	383	<b>972/B</b> 415
<b>971/A</b>	413	<b>972/A</b> 445
<b>971/L</b>	493	<b>972/L</b> 525

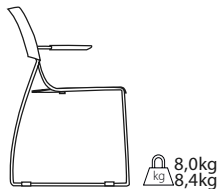

### With Arms





- NON UPHOLSTERED** Polypropylene
- SEAT UPHOLSTERED** Group D
- SEAT UPHOLSTERED** Group C & COF
- SEAT UPHOLSTERED** Group B & Valencia
- SEAT UPHOLSTERED** Grupo A
- SEAT UPHOLSTERED** Soft leather
- SEAT & BACK UPHOLSTERED** Group D
- SEAT & BACK UPHOLSTERED** Group C & COF
- SEAT & BACK UPHOLSTERED** Group B & Valencia
- SEAT & BACK UPHOLSTERED** Grupo A
- SEAT & BACK UPHOLSTERED** Soft leather

	Powder coated frame	Chromed frame
<b>973/P</b>	262	<b>974/P</b> 296
<b>973/S</b>	349	<b>974/S</b> 381
<b>973/Q</b>	355	<b>974/Q</b> 388
<b>973/N</b>	374	<b>974/N</b> 406
<b>973/O</b>	388	<b>974/O</b> 422
<b>973/R</b>	417	<b>974/R</b> 449
<b>973/D</b>	383	<b>974/D</b> 415
<b>973/C</b>	394	<b>974/C</b> 426
<b>973/B</b>	422	<b>974/B</b> 454
<b>973/A</b>	452	<b>974/A</b> 486
<b>973/L</b>	534	<b>974/L</b> 566

# Ados

Miguel Ángel Ciganda

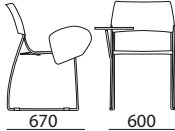
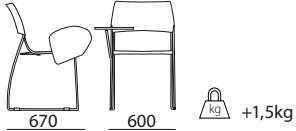
## ACCESSORIES

DRAWING	SPECIFICATION	REF.	Euros
	<b>LINKING DEVICE</b>	<b>967/A</b>	26
	<b>TRANSPORT AND STORAGE TROLLEY</b> (powder coated) 25 units	<b>968/A</b>	404
	<b>DESK TRAY RIGTH</b> (compact black or white)	<b>368/D</b>	142
	<b>DESK TRAY LEFT</b> (compact black or white)	<b>368/I</b>	142
	<b>PRICE INCREASE FOR FELT</b> (per chair)	<b>979/A</b>	17

---

# Muga & Muga-2

Pensi Design Studio



Expressiveness, sharpness and precision. The harmony between the high quality components and exceptional design results in an elegant and tremendously operative ensemble. The Muga office chair, initially designed for executive offices, is the living image of the change in corporate culture taking place in recent years. Muga creates an office environment inviting both creativity and team work.

Muga offers three back heights (low, medium and high) as well as different possibilities for its bases, backs and arms. Because every executive would rather be comfortable if they are to give the best of themselves.

Muga-2 is an operative office chair, ideal for those work environments striving to become spaces for meetings and creativity. The new corporate culture finds its design and functionality in this Muga-2.

With arms (in different materials and shapes, including the option of an adjustable arm) or without; with myriad upholstery options and a wide variety of bases... Muga-2 can be fully customized, but always combining design, effectiveness and usability.



# Muga

Pensi Design Studio

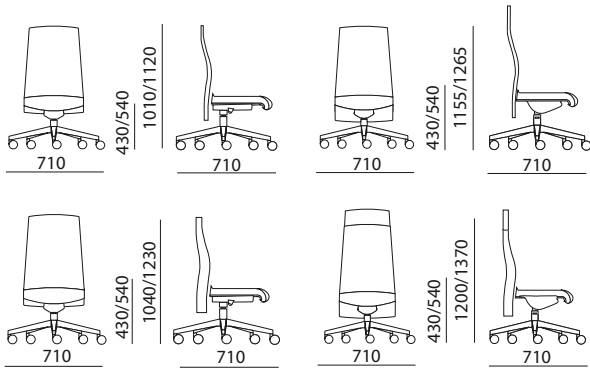

680x560x840mm 1 unit

Office chair with 5 support base in painted or polished aluminum, gas cylinder elevation, synchro mechanism, seat with depth adjustment option and upholstered back.

Option of fixed polished or painted aluminum arms, or 2D or 3D adjustable arms.

## DRAWING

## SPECIFICATION

**REF.** €uros

**REF.** €uros

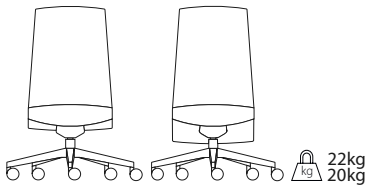

### Medium Back

- FULLY UPHOLSTERED** Group D
- FULLY UPHOLSTERED** Group C & COF
- FULLY UPHOLSTERED** Group B & Valencia
- FULLY UPHOLSTERED** Group A & COL
- FULLY UPHOLSTERED** Soft leather

### DEPTH SEAT ADJUSTMENT SUPPLEMENT

Measure: Fixed back 1,6m/22 feet. Measure: Adjustable back 1,7/24 feet. For projects, please contact the factory.

#### Fixed back

#### Adjustable back

<b>052/D</b>	891	<b>076/D</b>	999
<b>053/C</b>	905	<b>076/C</b>	1.015
<b>054/B</b>	965	<b>077/B</b>	1.084
<b>054/A</b>	1.042	<b>078/A</b>	1.173
<b>055/S</b>	1.306	<b>079/L</b>	1.464
	76		76

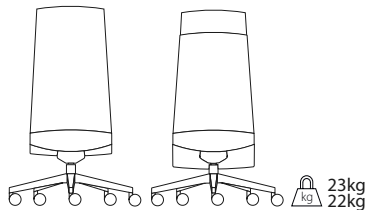

### High Back

- FULLY UPHOLSTERED** Group D
- FULLY UPHOLSTERED** Group C & COF
- FULLY UPHOLSTERED** Group B & Valencia
- FULLY UPHOLSTERED** Group A & COL
- FULLY UPHOLSTERED** Soft leather

### DEPTH SEAT ADJUSTMENT SUPPLEMENT

NOTE: SPECIFY SOFT OR HARD CASTORS OR GLIDES. IF THERE IS NO SPECIFICATION HARD CASTORS WILL BE SENT. BASE IN POLISHED OR PAINTED ALUMINIUM.







Measure: Fixed back 1,7m/24 feet. For projects, please contact the factory.

#### Fixed back

#### Adjustable back

<b>060/D</b>	900	<b>084/D</b>	1.239
<b>060/C</b>	916	<b>084/C</b>	1.258
<b>061/B</b>	983	<b>085/B</b>	1.379
<b>062/A</b>	1.054	<b>086/A</b>	1.473
<b>063/S</b>	1.329	<b>087/L</b>	1.775
	76		76

## ACCESSORIES

DRAWING	SPECIFICATION	REF.	Euros
 635/735 745/845  +2kg	<b>ADJUSTABLE 2D ARMS BLACK</b> (per chair)	<b>AC001</b>	101
	<b>ADJUSTABLE 3D ARMS BLACK</b> (per chair)	<b>AC002</b>	129
 657/767  +2kg	<b>POLISHED OR POWDER COATED ALUMINUM FIXED ARMS</b> (per chair)	<b>AC004</b>	172
	<b>ARMRESTS UPHOLTERED IN SOFT LEATHER FOR FIXED ARMS</b> (per chair)	<b>AC005</b>	99
	<b>FELT GLIDES</b> (per chair)	<b>AC003</b>	30

# Muga-2

Pensi Design Studio

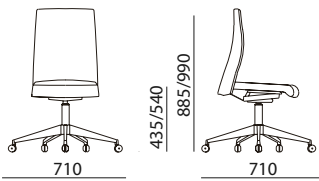

680x560x740mm 1 unit

Office chair with backrest in polypropylene adjustable in height with front upholstery. 5 star base in polyamide or aluminium. Multi-positional synchro mechanism and gas height adjustment and seat with depth adjustment.

Fixed arms offered in polyamide, polished aluminium or powder coated finish with a further option of 2D or 3D adjustable arms

## DRAWING

## SPECIFICATION

## REF.

## €uros

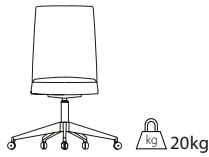

### Muga-2

**SEAT & BACK UPHOLSTERED** Group D

**090/D**

630

**SEAT & BACK UPHOLSTERED** Group C & COF

**090/C**

649

**SEAT & BACK UPHOLSTERED** Group B & Valencia

**090/B**

690

**SEAT & BACK UPHOLSTERED** Group A & COL

**090/A**

738

**SEAT & BACK UPHOLSTERED** Soft leather

**090/L**

850

**POLISHED OR PAINTED ALUMINUM BASE SUPPLEMENT**

**AC033**

92

NOTE: SPECIFY SOFT OR HARD CASTORS OR GLIDES. IF THERE IS NO SPECIFICATION HARD CASTORS WILL BE SENT. BASE IN POLYAMIDE BLACK, WHITE OR GREY.

Measure: 0,77ml/14 feet. For projects, please contact the factory.

## ACCESSORIES

## DRAWING

## SPECIFICATION

## REF.

## €uros



**ADJUSTABLE 2D ARMS BLACK**  
(per chair)

**AC001**

101

**ADJUSTABLE 3D ARMS BLACK**  
(per chair)

**AC002**

129



**FIXED POLYAMIDE ARMS**  
Black, white or grey (per chair)

**AC006**

101

**FIXED ALUMINIUM POLISHED OR POWDER COATED ARMS** (per chair)

**AC004**

172



**ARMRESTS UPHOLSTERED IN SOFT LEATHER FOR FIXED ARMS** (per chair)

**AC005**

99



**FELT GLIDES** (per chair)

**AC003**

30



---

# Hanna

Francesc Rifé



A feminine piece of pure and elegant lines which invites you to nestle down cosily yet which is also cordially open to others. Welcoming, comfortable and sensual; Hanna is perfect for decorating work spaces, places to receive the visits of collaborators and customers... or spaces to be lived in.

Whether inside our homes or out (a hotel lounge or dining room), this chair loves to discover new places and will always welcome you with its arms wide open. Hanna adapts to any atmosphere and context thanks to its different variations.

Its timeless design combines character and harmony with different materials, offering up to five different options of leg type. Aluminium, steel or wood create a versatile ensemble visible in the two available heights that can turn Hanna into an elegant armchair.



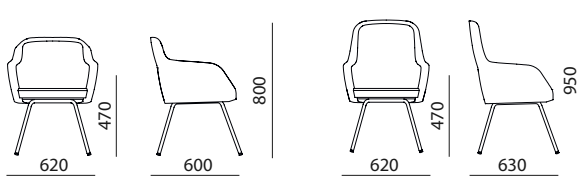

# Hanna 4 Legs

Francesc Rifé



Armchair, made of powder coated steel tube frame of Ø22mm, 4 legs with glides. Option glides with felt with price increase.

Shell in one piece of beech veneer upholstered in fabric or leather. Available in two heights.

Low back	 680x560x840mm	 1 unit
High back	 680x560x940mm	 1 unit

## DRAWING

## SPECIFICATION

## REF.

## €uros

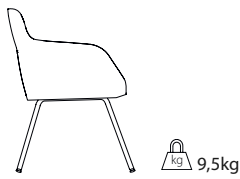

### Low Back

- FULLY UPHOLSTERED** Group D
- FULLY UPHOLSTERED** Group C & COF
- FULLY UPHOLSTERED** Group B & Valencia
- FULLY UPHOLSTERED** Group A & COL
- FULLY UPHOLSTERED** Soft leather

<b>HA10/D</b>	578
<b>HA10/C</b>	649
<b>HA10/B</b>	722
<b>HA10/A</b>	875
<b>HA10/L</b>	1.123

Measure: Low back 2m/36 feet. For projects, please contact the factory.

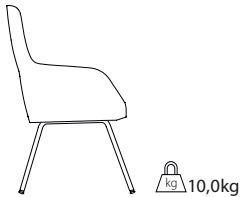

### High Back

- FULLY UPHOLSTERED** Group D
- FULLY UPHOLSTERED** Group C & COF
- FULLY UPHOLSTERED** Group B & Valencia
- FULLY UPHOLSTERED** Group A & COL
- FULLY UPHOLSTERED** Soft leather

<b>HH10/D</b>	653
<b>HH10/C</b>	722
<b>HH10/B</b>	793
<b>HH10/A</b>	974
<b>HH10/L</b>	1.233

Measure: High back 2,30m/38 feet. For projects, please contact the factory.

## ACCESSORIES

## DRAWING

## SPECIFICATION

## REF.

## €uros







**PRICE INCREASE FOR FELT** (per chair)

<b>AC077</b>	10
--------------	----

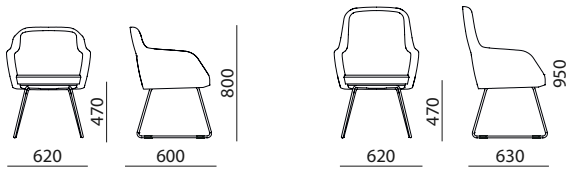
# Hanna Sled

Francesc Rifé



Low back  680x560x840mm  1 unit  
 High back  680x560x940mm  1 unit

Armchair, made of powder coated steel tube frame of Ø14mm and with translucent glides.

Shell available in two heights. Shell in one piece of beech veneer upholstered in fabric or leather.

Option translucent glides with felt with price increase.

## DRAWING

## SPECIFICATION

## REF.

## €uros

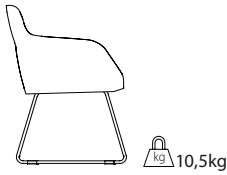

### Low Back

**FULLY UPHOLSTERED** Group D  
**FULLY UPHOLSTERED** Group C & COF  
**FULLY UPHOLSTERED** Group B & Valencia  
**FULLY UPHOLSTERED** Group A & COL  
**FULLY UPHOLSTERED** Soft leather

<b>HA11/D</b>	605
<b>HA11/C</b>	676
<b>HA11/B</b>	749
<b>HA11/A</b>	905
<b>HA11/L</b>	1.150

**ATTENTION THE FIRTS PRICES ARE FOR THE SEAT WITHOUT GLIDES. THE GLIDES HAVE A PRICE INCREASE.**  
 Measure: Low back 2m/36 feet. For projects, please contact the factory.

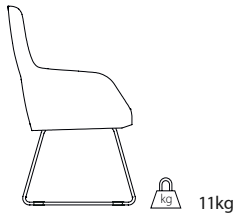

### High Back

**FULLY UPHOLSTERED** Group D  
**FULLY UPHOLSTERED** Group C & COF  
**FULLY UPHOLSTERED** Group B & Valencia  
**FULLY UPHOLSTERED** Group A & COL  
**FULLY UPHOLSTERED** Soft leather

<b>HH11/D</b>	685
<b>HH11/C</b>	752
<b>HH11/B</b>	825
<b>HH11/A</b>	1.006
<b>HH11/L</b>	1.265

**ATTENTION THE FIRTS PRICES ARE FOR THE SEAT WITHOUT GLIDES. THE GLIDES HAVE A PRICE INCREASE.**  
 Measure: High back 2,30m/38 feet. For projects, please contact the factory.

## ACCESSORIES

## DRAWING

## SPECIFICATION

## REF.

## €uros







**PRICE INCREASE FOR FELT** (per chair)

<b>AC041</b>	13
--------------	----

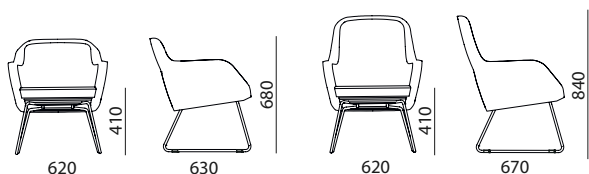
# Hanna Sled Lounge

Francesc Rifé



Low back  680x560x740mm  1 unit  
 High back  680x560x840mm  1 unit

Lounge armchair, made of powder coated steel tube frame of Ø14mm and with translucent glides.

Shell available in two heights. Shell in one piece of beech veneer upholstered in fabric or leather.

Option translucent glides with felt with price increase.

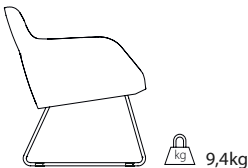
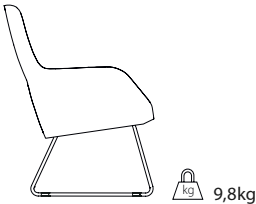
DRAWING	SPECIFICATION	REF.	€uros	
 <p>9,4kg</p>	<p><b>Low Back</b></p> <p><b>FULLY UPHOLSTERED</b> Group D</p> <p><b>FULLY UPHOLSTERED</b> Group C &amp; COF</p> <p><b>FULLY UPHOLSTERED</b> Group B &amp; Valencia</p> <p><b>FULLY UPHOLSTERED</b> Group A &amp; COL</p> <p><b>FULLY UPHOLSTERED</b> Soft leather</p>	<p><b>HA12/D</b></p> <p><b>HA12/C</b></p> <p><b>HA12/B</b></p> <p><b>HA12/A</b></p> <p><b>HA12/L</b></p>	<p>605</p> <p>676</p> <p>749</p> <p>905</p> <p>1.150</p>	
	<p><b>ATTENTION THE FIRTS PRICES ARE FOR THE SEAT WITHOUT GLIDES. THE GLIDES HAVE A PRICE INCREASE.</b>                      Measure: Low back 2ml/36 feet. For projects, please contact the factory.</p>			
	 <p>9,8kg</p>	<p><b>High Back</b></p> <p><b>FULLY UPHOLSTERED</b> Group D</p> <p><b>FULLY UPHOLSTERED</b> Group C &amp; COF</p> <p><b>FULLY UPHOLSTERED</b> Group B &amp; Valencia</p> <p><b>FULLY UPHOLSTERED</b> Group A &amp; COL</p> <p><b>FULLY UPHOLSTERED</b> Soft leather</p>	<p><b>HH12/D</b></p> <p><b>HH12/C</b></p> <p><b>HH12/B</b></p> <p><b>HH12/A</b></p> <p><b>HH12/L</b></p>	<p>685</p> <p>752</p> <p>825</p> <p>1.006</p> <p>1.265</p>
		<p><b>ATTENTION THE FIRTS PRICES ARE FOR THE SEAT WITHOUT GLIDES. THE GLIDES HAVE A PRICE INCREASE.</b>                      Measure: High back 2,30ml/38 feet. For projects, please contact the factory.</p>		

## ACCESSORIES

DRAWING	SPECIFICATION	REF.	€uros
	<p><b>PRICE INCREASE FOR FELT</b> (per chair)</p>	<p><b>AC041</b></p>	<p>13</p>



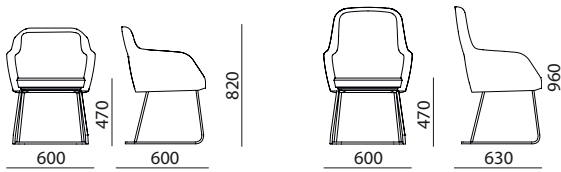

# Hanna Cantilevered

Francesc Rifé



Armchair, made of powder coated steel frame.

Shell in one piece of beech veneer upholstered in fabric or leather. Available in two heights.

Low back  680x560x840mm  1 unit  
 High back  680x560x940mm  1 unit

## DRAWING

## SPECIFICATION

## REF.

## €uros

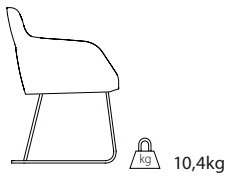

### Low Back

**FULLY UPHOLSTERED** Group D  
**FULLY UPHOLSTERED** Group C & COF  
**FULLY UPHOLSTERED** Group B & Valencia  
**FULLY UPHOLSTERED** Group A & COL  
**FULLY UPHOLSTERED** Soft leather

<b>HA18/D</b>	667
<b>HA18/C</b>	738
<b>HA18/B</b>	811
<b>HA18/A</b>	967
<b>HA18/L</b>	1.212

Measure: Low back 2m/36 feet. For projects, please contact the factory.

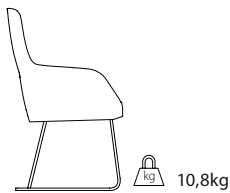

### High Back

**FULLY UPHOLSTERED** Group D  
**FULLY UPHOLSTERED** Group C & COF  
**FULLY UPHOLSTERED** Group B & Valencia  
**FULLY UPHOLSTERED** Group A & COL  
**FULLY UPHOLSTERED** Soft leather

<b>HH18/D</b>	742
<b>HH18/C</b>	811
<b>HH18/B</b>	884
<b>HH18/A</b>	1.063
<b>HH18/L</b>	1.322

Measure: High back 2,30m/38 feet. For projects, please contact the factory.



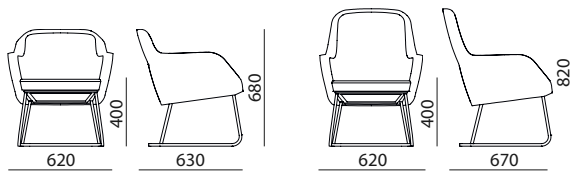

# Hanna Cantilevered Lounge

Francesc Rifé



Lounge armchair, made of powder coated steel frame.

Shell in one piece of beech veneer upholstered in fabric or leather. Available in two heights.

Low back	 680x560x740mm	 1 unit
High back	 680x560x840mm	 1 unit

## DRAWING

## SPECIFICATION

## REF.

## €uros

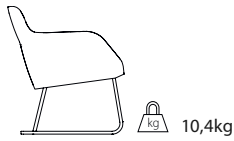

### Low Back

<b>FULLY UPHOLSTERED</b> Group D
<b>FULLY UPHOLSTERED</b> Group C & COF
<b>FULLY UPHOLSTERED</b> Group B & Valencia
<b>FULLY UPHOLSTERED</b> Group A & COL
<b>FULLY UPHOLSTERED</b> Soft leather

<b>HA19/D</b>	667
<b>HA19/C</b>	738
<b>HA19/B</b>	811
<b>HA19/A</b>	967
<b>HA19/L</b>	1.212

Measure: Low back 2m/36 feet. For projects, please contact the factory.

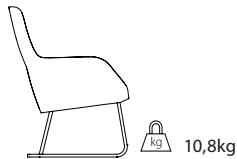

### High Back

<b>FULLY UPHOLSTERED</b> Group D
<b>FULLY UPHOLSTERED</b> Group C & COF
<b>FULLY UPHOLSTERED</b> Group B & Valencia
<b>FULLY UPHOLSTERED</b> Group A & COL
<b>FULLY UPHOLSTERED</b> Soft leather





<b>HH19/D</b>	742
<b>HH19/C</b>	811
<b>HH19/B</b>	884
<b>HH19/A</b>	1.063
<b>HH19/L</b>	1.322

Measure: High back 2,30m/38 feet. For projects, please contact the factory.

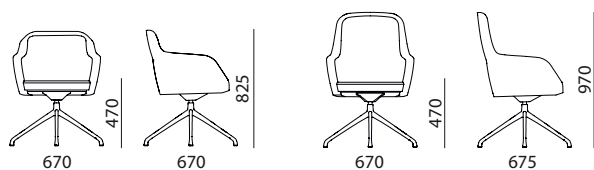
# Hanna Swivel

Francesc Rifé



Low back  680x560x840mm  1 unit  
 High back  680x560x940mm  1 unit

Armchair, made of polished or powder coated injected aluminium swivel base.

Shell available in two heights. Shell in one piece of beech veneer upholstered in fabric or leather.

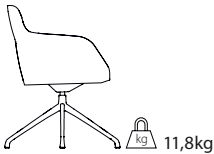
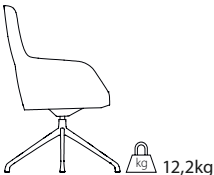
DRAWING	SPECIFICATION	REF.	Euros	
 11,8kg	<u>Low Back</u> <b>FULLY UPHOLSTERED</b> Group D <b>FULLY UPHOLSTERED</b> Group C & COF <b>FULLY UPHOLSTERED</b> Group B & Valencia <b>FULLY UPHOLSTERED</b> Group A & COL <b>FULLY UPHOLSTERED</b> Soft leather	<b>HA17/D</b> <b>HA17/C</b> <b>HA17/B</b> <b>HA17/A</b> <b>HA17/L</b>	722 793 866 1.022 1.267	
	Measure: Low back 2m/36 feet. For projects, please contact the factory.			
	 12,2kg	<u>High Back</u> <b>FULLY UPHOLSTERED</b> Group D <b>FULLY UPHOLSTERED</b> Group C & COF <b>FULLY UPHOLSTERED</b> Group B & Valencia <b>FULLY UPHOLSTERED</b> Group A & COL <b>FULLY UPHOLSTERED</b> Soft leather	<b>HH17/D</b> <b>HH17/C</b> <b>HH17/B</b> <b>HH17/A</b> <b>HH17/L</b>	788 855 928 1.107 1.368
		Measure: High back 2,30m/38 feet. For projects, please contact the factory.		





## ACCESSORIES

DRAWING	SPECIFICATION	REF.	Euros
	<b>PRICE INCREASE FOR FELT</b> (per chair)	<b>ACP1</b>	14

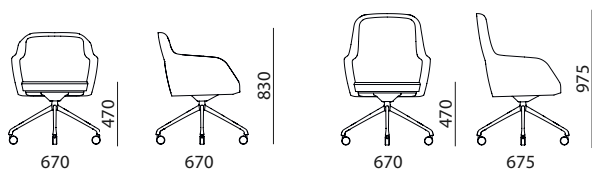
# Hanna Swivel with Castors

Francesc Rifé



Low back  680x560x840mm  1 unit  
 High back  680x560x940mm  1 unit

Armchair, made of polished or powder coated injected aluminium swivel base with castors soft or hard.

Shell available in two heights. Shell in one piece of beech veneer upholstered in fabric or leather.

## DRAWING

## SPECIFICATION

## REF.

## €uros

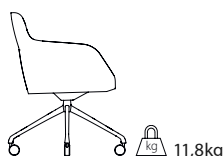

### Low Back

**FULLY UPHOLSTERED** Group D  
**FULLY UPHOLSTERED** Group C & COF  
**FULLY UPHOLSTERED** Group B & Valencia  
**FULLY UPHOLSTERED** Group A & COL  
**FULLY UPHOLSTERED** Soft leather

<b>HA22/D</b>	678
<b>HA22/C</b>	749
<b>HA22/B</b>	825
<b>HA22/A</b>	978
<b>HA22/L</b>	1.223

Measure: Low back 2m/36 feet. For projects, please contact the factory.

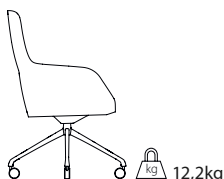

### High Back

**FULLY UPHOLSTERED** Group D  
**FULLY UPHOLSTERED** Group C & COF  
**FULLY UPHOLSTERED** Group B & Valencia  
**FULLY UPHOLSTERED** Group A & COL  
**FULLY UPHOLSTERED** Soft leather

<b>HH22/D</b>	745
<b>HH22/C</b>	811
<b>HH22/B</b>	884
<b>HH22/A</b>	1.065
<b>HH22/L</b>	1.324





**NOTE: SPECIFY SOFT OR HARD CASTORS. IF THERE IS NO SPECIFICATION HARD CASTORS WILL BE SENT.**  
 Measure: High back 2,30m/38 feet. For projects, please contact the factory.

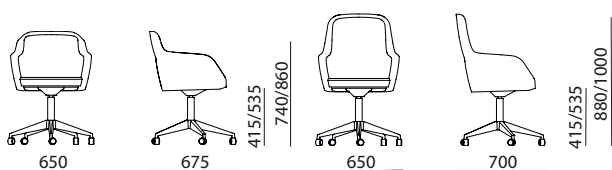

# Hanna Office

Francesc Rifé



Low back  630x630x580mm  1 unit  
 High back  680x560x610mm  1 unit

Office armchair fully upholstered. Base of 5 legs in polyamide available in 3 colours or polished or painted aluminum with supplement and gas cylinder elevation and tilt mechanism.

Shell available in two heights. Shell in one piece of beech veneer upholstered in fabric or leather.

## DRAWING

## SPECIFICATION

## REF.

## €uros



### Low Back

**FULLY UPHOLSTERED** Group D

**HA23/D** 653

**FULLY UPHOLSTERED** Group C & COF

**HA23/C** 724

**FULLY UPHOLSTERED** Group B & Valencia

**HA23/B** 797

**FULLY UPHOLSTERED** Group A & COL

**HA23/A** 953

**FULLY UPHOLSTERED** Soft leather

**HA23/L** 1.198

**PAINTED OR POLISHED ALUMINUM BASE SUPPLEMENT**

**AC033** 92

Measure: Low back 2m/36 feet. For projects, please contact the factory.

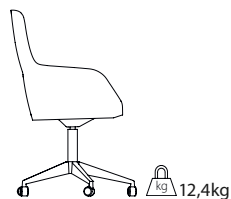

### High Back

**FULLY UPHOLSTERED** Group D

**HH23/D** 738

**FULLY UPHOLSTERED** Group C & COF

**HH23/C** 807

**FULLY UPHOLSTERED** Group B & Valencia

**HH23/B** 880

**FULLY UPHOLSTERED** Group A & COL

**HH23/A** 1.058

**FULLY UPHOLSTERED** Soft leather

**HH23/L** 1.317

**PAINTED OR POLISHED ALUMINUM BASE SUPPLEMENT**

**AC033** 92





NOTE: SPECIFY SOFT OR HARD CASTORS. IF THERE IS NO SPECIFICATION HARD CASTORS WILL BE SENT. BLACK, WHITE OR GREY POLYAMIDE BASE.

Measure: High back 2,30m/38 feet. For projects, please contact the factory.

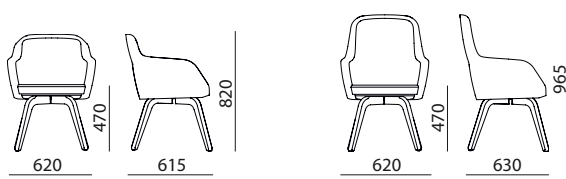
# Hanna Wood

Francesc Rifé



Low back  680x560x840mm  1 unit  
 High back  680x560x940mm  1 unit

Armchair, frame made of birch plywood 30mm thickness mat natural or black varnished.

Shell available in two heights. Shell in one piece of beech veneer upholstered in fabric or leather.

## DRAWING

## SPECIFICATION

## REF.

## €uros

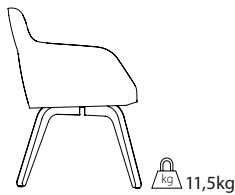

### Low Back

**FULLY UPHOLSTERED** Group D  
**FULLY UPHOLSTERED** Group C & COF  
**FULLY UPHOLSTERED** Group B & Valencia  
**FULLY UPHOLSTERED** Group A & COL  
**FULLY UPHOLSTERED** Soft leather

HA15/D	761
HA15/C	809
HA15/B	871
HA15/A	1.026
HA15/L	1.274

Measure: Low back 2m/36 feet. For projects, please contact the factory.

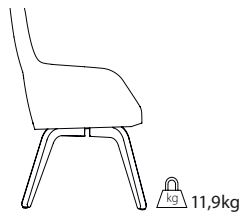

### High Back

**FULLY UPHOLSTERED** Group D  
**FULLY UPHOLSTERED** Group C & COF  
**FULLY UPHOLSTERED** Group B & Valencia  
**FULLY UPHOLSTERED** Group A & COL  
**FULLY UPHOLSTERED** Soft leather

HH15/D	827
HH15/C	873
HH15/B	933
HH15/A	1.113
HH15/L	1.374





**NOTE: OPTION WOOD BASE WITH MAT NATURAL OR BLACK VARNISHED.**

Measure: High back 2,30m/38 feet. For projects, please contact the factory.

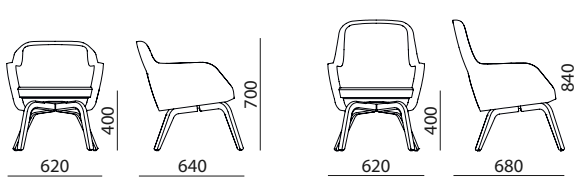
# Hanna Wood Lounge

Francesc Rifé



Low back  680x560x740mm  1 unit  
 High back  680x560x840mm  1 unit

Lounge armchair, frame made of birch plywood 30mm thickness mat natural or black varnished.

Shell available in two heights. Shell in one piece of beech veneer upholstered in fabric or leather.

## DRAWING

## SPECIFICATION

## REF.

## €uros

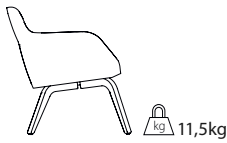

### Low Back

**FULLY UPHOLSTERED** Group D  
**FULLY UPHOLSTERED** Group C & COF  
**FULLY UPHOLSTERED** Group B & Valencia  
**FULLY UPHOLSTERED** Group A & COL  
**FULLY UPHOLSTERED** Soft leather

<b>HA16/D</b>	859
<b>HA16/C</b>	910
<b>HA16/B</b>	971
<b>HA16/A</b>	1.127
<b>HA16/L</b>	1.374

Measure: Low back 2m/36 feet. For projects, please contact the factory.

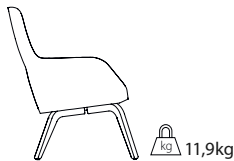

### High Back

**FULLY UPHOLSTERED** Group D  
**FULLY UPHOLSTERED** Group C & COF  
**FULLY UPHOLSTERED** Group B & Valencia  
**FULLY UPHOLSTERED** Group A & COL  
**FULLY UPHOLSTERED** Soft leather

<b>HH16/D</b>	960
<b>HH16/C</b>	1.008
<b>HH16/B</b>	1.068
<b>HH16/A</b>	1.249
<b>HH16/L</b>	1.507

**NOTE: OPTION WOOD BASE WITH MAT NATURAL OR BLACK VARNISHED.**

Measure: High back 2,30m/38 feet. For projects, please contact the factory.

# Hanna Table

Francesc Rifé

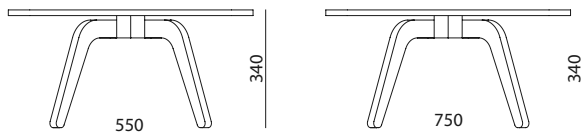



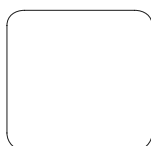

Table of 550x550mm and 750x750mm, table top of melamine or wood, and frame made of birch plywood 30mm thickness mat natural or black varnished.

Table top 550x550mm  630x630x580mm  unit  
Table top 750x750mm  810x690x945mm  unit

## DRAWING



## MEASURES mm

### Hanna Table

H 340mm  
550 x 550mm  7,5kg

H 340mm  
750 x 750mm  8,5kg

**REF.**    **€uros**

**REF.**    **€uros**

Melamine 20mm

Wood 20mm

**019/M**    456

**019/J**    573

**019/K**    491

**019/L**    777

NOTE: OPTION WOOD BASE IN MAT NATURAL OR BLACK.  
OTHER TABLE MEASUREMENTS AVAILABLE. PLEASE CHECK AVAILABILITY.

---

# Xoko & Gune

Iratzoki Lizaso



A collection of stools for sharing thoughts and ideas in collaborative environments. With generous seat dimensions, Xoko is at the same time both symmetrical and asymmetrical. Its unique shape envelops the user. Its design makes it possible to sit in different directions, yet retain comfort.

The Xoko stools program livens up spaces and helps to foster conversations and the sharing of ideas. In open areas, it offers different configurations where you can just sit and connect with the physical space.





As for the Gune tables, its rounded corners that define a kind contour. The cross-shaped base and rounded vertices enhance the character of the Gune table program. The possibility of a double countertops brings another dimension to the table and functions as an auxiliary surface, thus allowing more space.

Gune is a program of tables with multiple configuration possibilities to form casual spaces, both work and leisure. Gune tables are available in 5 heights to combine with stools and chairs in both working and lounge spaces. There is a simple column option as well as an elongated version with two columns.

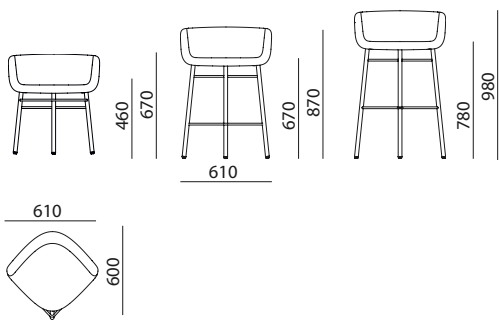
# Xoko

Iratzoki Lizaso



Height 460/670mm  680x570x970mm  1 unit  
 Height 780mm  680x570x1100mm  1 unit

Stool program for collaborative spaces, 4 legs frame on steel tube of Ø20mm and 3 heights, powder coated.

Seat in one piece, injected in polyurethane and fully upholstered.

Option glides with felt with supplement.

## DRAWING

## SPECIFICATION

## REF.

## Euros



### Height 460mm

- FULLY UPHOLSTERED** Group D
- FULLY UPHOLSTERED** Group C & COF
- FULLY UPHOLSTERED** Group B & Valencia
- FULLY UPHOLSTERED** Group A & COL
- FULLY UPHOLSTERED** Soft leather

<b>XK08/D</b>	468
<b>XK08/C</b>	497
<b>XK08/B</b>	559
<b>XK08/A</b>	610
<b>XK08/L</b>	694

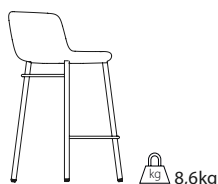

### Height 670mm

- FULLY UPHOLSTERED** Group D
- FULLY UPHOLSTERED** Group C & COF
- FULLY UPHOLSTERED** Group B & Valencia
- FULLY UPHOLSTERED** Group A & COL
- FULLY UPHOLSTERED** Soft leather

<b>XK01/D</b>	484
<b>XK01/C</b>	511
<b>XK01/B</b>	575
<b>XK01/A</b>	626
<b>XK01/L</b>	710

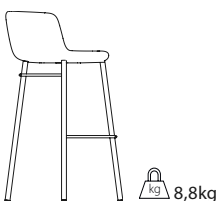

### Height 780mm

- FULLY UPHOLSTERED** Group D
- FULLY UPHOLSTERED** Group C & COF
- FULLY UPHOLSTERED** Group B & Valencia
- FULLY UPHOLSTERED** Group A & COL
- FULLY UPHOLSTERED** Soft leather

<b>XK02/D</b>	497
<b>XK02/C</b>	525
<b>XK02/B</b>	589
<b>XK02/A</b>	639
<b>XK02/L</b>	724

Measure: 1,2ml/16 feet. For projects, please contact the factory.

## ACCESSORIES

## DRAWING

## SPECIFICATION

## REF.

## Euros



**PRICE INCREASE FOR FELT** (per chair)

<b>ACX01</b>	10
--------------	----

# Xoko Collaborative

Iratzoki Lizaso

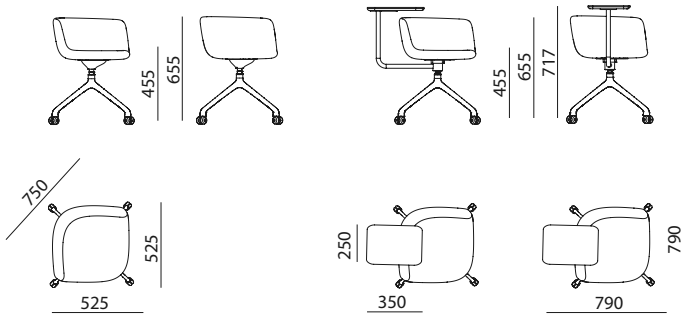

680x540x740mm 1 unit

Xoko collaborative with swivel base in aluminium powder coated or polished, and with soft or hard castors.

Desk tray as an option with 360° movement in 20mm plywood laminated 20mm with chamfered edge, 350x250mm.

Seat in one piece, injected in polyurethane fully upholstered.

## DRAWING

## SPECIFICATION

## REF.

## €uros

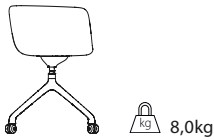

### Without Desk Tray

- FULLY UPHOLSTERED** Group D
- FULLY UPHOLSTERED** Group C & COF
- FULLY UPHOLSTERED** Group B & Valencia
- FULLY UPHOLSTERED** Group A & COL
- FULLY UPHOLSTERED** Soft leather

<b>XK06/D</b>	649
<b>XK06/C</b>	676
<b>XK06/B</b>	742
<b>XK06/A</b>	795
<b>XK06/L</b>	887

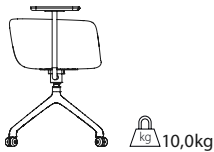

### With Desk Tray 360°

- FULLY UPHOLSTERED** Group D
- FULLY UPHOLSTERED** Group C & COF
- FULLY UPHOLSTERED** Group B & Valencia
- FULLY UPHOLSTERED** Group A & COL
- FULLY UPHOLSTERED** Soft leather

<b>XK07/D</b>	797
<b>XK07/C</b>	827
<b>XK07/B</b>	894
<b>XK07/A</b>	946
<b>XK07/L</b>	1.038

NOTE: SPECIFY SOFT OR HARD CASTORS. IF THERE IS NO SPECIFICATION HARD CASTORS WILL BE SENT.  
DESK TRAY IN PLYWOOD LAMINATED CHAMFERED EDGE.

Measure: 1,2ml/16 feet. For projects, please contact the factory.

# Xoko Central Column

Iratzoki Lizaso

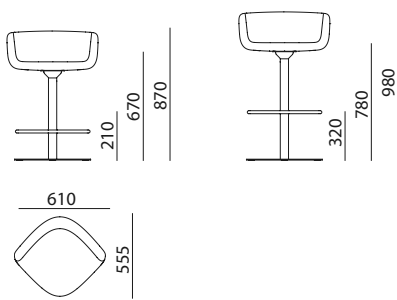

680x570x970mm 1 unit

Swivel stool program for collaborative spaces, structure with central column and fixed height, available in two heights and powder coated.

Seat in one piece, injected in polyurethane and fully upholstered.

DRAWING	SPECIFICATION	REF.	Euros
	<b>Height 670mm</b>		
	<b>FULLY UPHOLSTERED</b> Group D	<b>XK10/D</b>	681
	<b>FULLY UPHOLSTERED</b> Group C & COF	<b>XK10/C</b>	708
	<b>FULLY UPHOLSTERED</b> Group B & Valencia	<b>XK10/B</b>	777
	<b>FULLY UPHOLSTERED</b> Group A & COL	<b>XK10/A</b>	829
	<b>FULLY UPHOLSTERED</b> Soft leather	<b>XK10/L</b>	919
	<b>Height 780mm</b>		
	<b>FULLY UPHOLSTERED</b> Group D	<b>XK11/D</b>	685
	<b>FULLY UPHOLSTERED</b> Group C & COF	<b>XK11/C</b>	713
	<b>FULLY UPHOLSTERED</b> Group B & Valencia	<b>XK11/B</b>	781
	<b>FULLY UPHOLSTERED</b> Group A & COL	<b>XK11/A</b>	834
	<b>FULLY UPHOLSTERED</b> Soft leather	<b>XK11/L</b>	923

Measure: 1,2m/16 feet. For projects, please contact the factory.



# Gune

Iratzoki Lizaso

Table program for collaborative spaces, made of steel base powder coated option.

Table tops in melamine, wood, compact - HPL or plywood laminated. Available in 5 heights. With leveling glides.

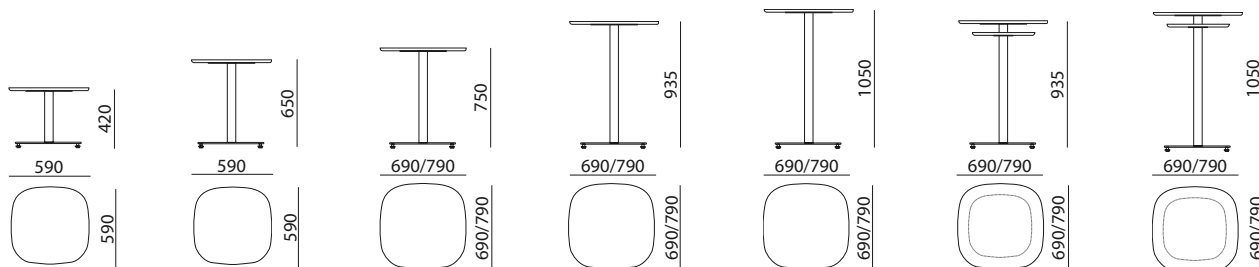

Type of edges per table top:

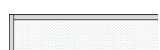

Melamine and wood:  
Straight edges



Compact - HPL:  
Straight edges, black body

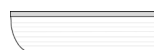

Plywood laminated:  
Rounded edges

DRAWING

MEASURES mm

REF.

€uros

REF.

€uros

REF.

€uros

## ONE TOP

	<u>Central Column</u>
	H 420mm 590x590mm  18,0kg
	H 650mm 590x590mm  18,5kg
	H 750mm 690x690mm  19,0kg
	H 750mm 790x790mm  20,0kg
	H 935mm 690x690mm  22,0kg
	H 935mm 790x790mm  23,0kg
	H 1050mm 690x690mm  22,5kg
	H 1050mm 790x790mm  23,5kg

	Melamine 19mm		Plywood laminated 20mm / Compact - HPL 12mm		Wood 19mm
<b>GU01/M</b>	520	<b>GU01/C</b>	687	<b>GU01/W</b>	742
<b>GU02/M</b>	548	<b>GU02/C</b>	717	<b>GU02/W</b>	768
<b>GU03/M</b>	591	<b>GU03/C</b>	811	<b>GU03/W</b>	873
<b>GU04/M</b>	605	<b>GU04/C</b>	882	<b>GU04/W</b>	960
<b>GU05/M</b>	600	<b>GU05/C</b>	820	<b>GU05/W</b>	887
<b>GU06/M</b>	614	<b>GU06/C</b>	891	<b>GU06/W</b>	969
<b>GU07/M</b>	610	<b>GU07/C</b>	829	<b>GU07/W</b>	891
<b>GU08/M</b>	623	<b>GU08/C</b>	898	<b>GU08/W</b>	976

## DOUBLE TOP

	<u>Central Column</u>
	H 935mm 690x690mm  26,5kg
	H 935mm 790x790mm  27,5kg
	H 1050mm 690x690mm  28,0kg
	H 1050mm 790x790mm  29,0kg

	Melamine 19mm		Plywood laminated 20mm / Compact - HPL 12mm		Wood 19mm
<b>GU09/M</b>	681	<b>GU09/C</b>	1.022	<b>GU09/W</b>	1.166
<b>GU10/M</b>	710	<b>GU10/C</b>	1.162	<b>GU10/W</b>	1.336
<b>GU11/M</b>	690	<b>GU11/C</b>	1.026	<b>GU11/W</b>	1.173
<b>GU12/M</b>	720	<b>GU12/C</b>	1.168	<b>GU12/W</b>	1.345

NOTE: TO CUSTOMIZE THE MEASUREMENTS CONTACT THE FACTORY.

# Gune

Iratzoki Lizaso

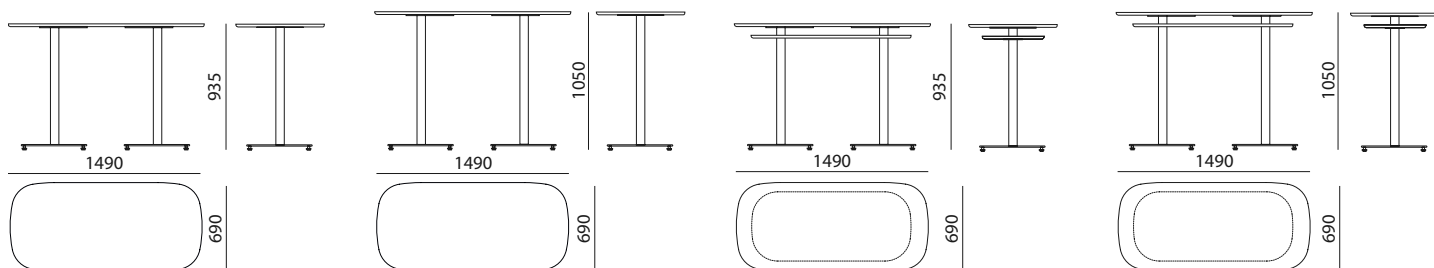

Type of edges per table top:







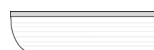

Melamine and wood:  
Straight edges



Compact - HPL:  
Straight edges, black body





Plywood laminated:  
Rounded edges

DRAWING	MEASURES mm	REF.	€uros	REF.	€uros	REF.	€uros
<b>ONE TOP</b>							
	<p><b><u>Double Separated Column</u></b></p> <p>H 935mm 1490x690mm  47,5kg</p> <p>H 1050mm 1490x690mm  48,5kg</p>	Melamine 19mm		Plywood laminated 20mm / Compact - HPL 12mm		Wood 19mm	
		<b>GU17/M</b>	1.145	<b>GU17/C</b>	1.546	<b>GU17/W</b>	1.636
		<b>GU18/M</b>	1.157	<b>GU18/C</b>	1.562	<b>GU18/W</b>	1.649
<b>DOUBLE TOP</b>							
	<p><b><u>Double Separated Column</u></b></p> <p>H 935mm 1490x690mm  55,5kg</p> <p>H 1050mm 1490x690mm  56,5kg</p>	Melamine 19mm		Plywood laminated 20mm / Compact - HPL 12mm		Wood 19mm	
		<b>GU19/M</b>	1.320	<b>GU19/C</b>	1.970	<b>GU19/W</b>	2.178
		<b>GU20/M</b>	1.333	<b>GU20/C</b>	1.981	<b>GU20/W</b>	2.194

NOTE: TO CUSTOMIZE THE MEASUREMENTS CONTACT THE FACTORY.

## ACCESSORIES

DRAWING	SPECIFICATION	REF.	Euros
 0,2kg	<b>USB CHARGER</b> Ø37mm grey colour <small>NOTE: THE POSITION OF THE CHARGER IS ON TOP OF THE COLUMN, AND THE CABLE MANAGEMENT INSIDE THE COLUMN.</small>	<b>AC057</b>	138
	<b>HANGER</b> 2 per column	<b>AC058</b>	21

---

# Ostoa

Ander Lizaso



Ostoa is a collection inspired by the natural and light beauty of a leaf. With charming and soft forms, the programme has been designed for soft-seating zones.

Thanks to its different sizes, materials and upholstery options, Ostoa offers the possibility of creating personalized surroundings. As it happens with the falling leaves in autumn, it allows designing harmonious combinations in an intuitive and unpremeditated way.

# Ostoa Pouf

Ander Lizaso

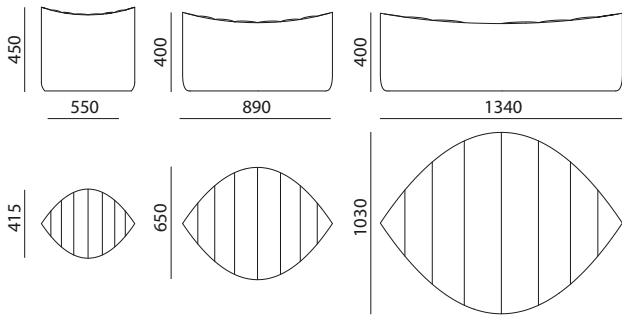



Pouf S	560x460x590mm	1 ud
Pouf M	570x670x770mm	1 ud
Pouf L	1050x1200x770mm	1 ud

Poufs available in 3 different dimensions upholstered in fabric. Glides included, felt glides with price increase.

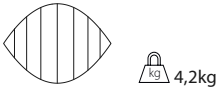
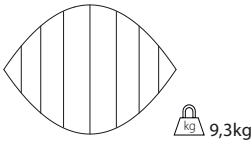
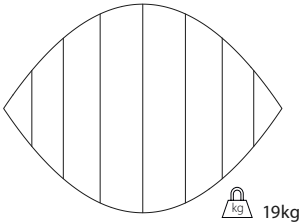
S and M dimension poufs available with handle.

DRAWING	SPECIFICATION	REF.	Euros
	<b>Pouf S</b>		
	<b>FULLY UPHOLSTERED</b> Group D	<b>OS01/D</b>	350
	<b>FULLY UPHOLSTERED</b> Group C & COF	<b>OS01/C</b>	376
	<b>FULLY UPHOLSTERED</b> Group B & Valencia	<b>OS01/B</b>	419
	<b>FULLY UPHOLSTERED</b> Group A	<b>OS01/A</b>	494
	Measure: Fabric 1,20ml. For projects, please contact the factory.		
	<b>Pouf M</b>		
	<b>FULLY UPHOLSTERED</b> Group D	<b>OS02/D</b>	524
	<b>FULLY UPHOLSTERED</b> Group C & COF	<b>OS02/C</b>	566
	<b>FULLY UPHOLSTERED</b> Group B & Valencia	<b>OS02/B</b>	636
	<b>FULLY UPHOLSTERED</b> Group A	<b>OS02/A</b>	760
	Measure: Fabric 1,9ml. For projects, please contact the factory.		
	<b>Pouf L</b>		
	<b>FULLY UPHOLSTERED</b> Group D	<b>OS03/D</b>	1.086
	<b>FULLY UPHOLSTERED</b> Group C & COF	<b>OS03/C</b>	1.161
	<b>FULLY UPHOLSTERED</b> Group B & Valencia	<b>OS03/B</b>	1.286
	<b>FULLY UPHOLSTERED</b> Group A	<b>OS03/A</b>	1.484
	Measure: Fabric 3,3ml. For projects, please contact the factory.		

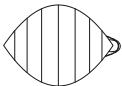
## ACCESSORIES

DRAWING	SPECIFICATION	REF.	Euros
	<b>HANDLE SUPPLEMENT</b> (supplement per pouf) Valid for pouf S and M.	<b>AC087</b>	14
	<b>PRICE INCREASE FOR FELT</b> (supplement per pouf)	<b>AC089</b>	12

# Ostoa Table

Ander Lizaso

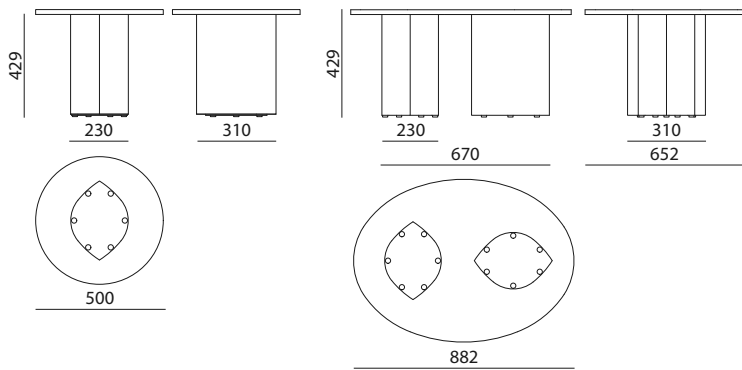

Table available in powder coated steel base or varnished natural oak wood base. Table tops with straight edges in 19mm melamine, 12mm compact - HPL, 19mm varnish wood or 19mm Fenix.

Rounded edges in 20mm plywood laminated.

Central column 520x540x590mm 1 ud  
 Double column 680x570x940mm 1 ud

Type of edges per table top:



Melamine, wood and Black Fenix:  
Straight edges:

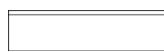

Compact - HPL:  
Straight edges, black body



Plywood laminated:  
Rounded edges

DRAWING

MEASURES mm

REF.

€uros

REF.

€uros

REF.

€uros

REF.

€uros

REF.

€uros

## CENTRAL COLUMN

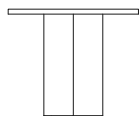

### Powder coated Base

H429mm  
Ø500mm 8,5kg

	Melamine 19mm	Compac - HPL 12mm	Wood 19mm	Plywood laminated 20mm	Black Fenix 20mm
<b>OS10/M</b>	335	<b>OS10/C</b>	366	<b>OS10/W</b>	400
		<b>OS10/E</b>	396	<b>OS10/F</b>	430

## CENTRAL COLUMN

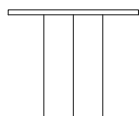

### Oak Wood Base

H429mm  
Ø500mm 8,5kg

	Melamine 19mm	Compac - HPL 12mm	Wood 19mm	Plywood laminated 20mm	Black Fenix 20mm
<b>OS11/M</b>	486	<b>OS11/C</b>	516	<b>OS11/W</b>	550
		<b>OS11/E</b>	546	<b>OS11/F</b>	580

## DOUBLE COLUMN

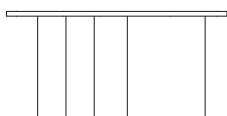

### Powder coated Base

H429mm  
882x652mm 15,6kg

	Melamine 19mm	Compac - HPL 12mm	Wood 19mm	Plywood laminated 20mm	Black Fenix 20mm
<b>OS12/M</b>	570	<b>OS12/C</b>	621	<b>OS12/W</b>	679
		<b>OS12/E</b>	672	<b>OS12/F</b>	731

## DOUBLE COLUMN

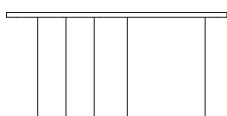

### Oak Wood Base

H429mm  
882x652mm 15,6kg

	Melamine 19mm	Compac - HPL 12mm	Wood 19mm	Plywood laminated 20mm	Black Fenix 20mm
<b>OS13/M</b>	874	<b>OS13/C</b>	928	<b>OS13/W</b>	990
		<b>OS13/E</b>	982	<b>OS13/F</b>	1.044

## ACCESSORIES

DRAWING

SPECIFICATION

REF.

€uros



**PRICE INCREASE FOR FELT** (supplement per table)



**AC092**

8

# Ostoa Armchair

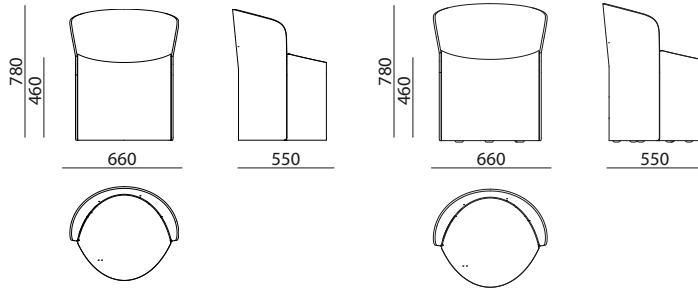
Ander Lizaso



 570X670X870 mm  1 ud

Armchair fully upholstered in fabric. Bentwood structure covered with foam of varying thickness. 19mm thick melamine base. Glides included.

Castors available with price increase.

## DRAWING

## SPECIFICATION

## REF.

## €uros

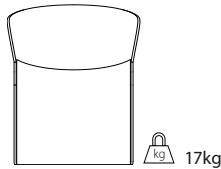

### Without Castors

- FULLY UPHOLSTERED** Group D
- FULLY UPHOLSTERED** Group C & COF
- FULLY UPHOLSTERED** Group B & Valencia
- FULLY UPHOLSTERED** Group A

<b>OS15/D</b>	719
<b>OS15/C</b>	801
<b>OS15/B</b>	944
<b>OS15/A</b>	1.165

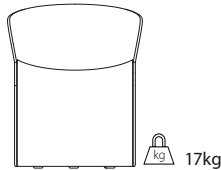

### With Castors

- FULLY UPHOLSTERED** Group D
- FULLY UPHOLSTERED** Group C & COF
- FULLY UPHOLSTERED** Group B & Valencia
- FULLY UPHOLSTERED** Group A

<b>OS16/D</b>	737
<b>OS16/C</b>	832
<b>OS16/B</b>	962
<b>OS16/A</b>	1.184

Measure: Fabric 2,75ml. For projects, please contact the factory.



---

# Topa

Pensi Design Studio



In our language, Topa means gathering with or meeting other people in a same place. That's the idea behind this collection of casual design and pure lines. The Topa collection is based on individual, easy-to-assemble pieces offering myriad layout possibilities.

A selection of armchairs, tables and pouffes serving to create different atmospheres for working or relaxing: offices, waiting areas, open spaces, chill-out or coworking spaces, spaces to meet, eat & take a break... The variety of materials and fabrics applicable to the whole collection helps to create connected atmospheres.



# Topa Pouf

Pensi Design Studio

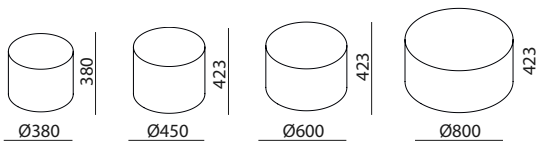

Poufs available in 4 different sizes, upholstered in fabric or soft leather with glides. Option glides with felt with supplement. Castors available with supplement for the pouf of Ø800mm.

Ø380		480x480x490mm		1 unit	Ø600		630x630x490mm		1 unit
Ø450		480x480x490mm		1 unit	Ø800		830x830x490mm		1 unit

## DRAWING

## SPECIFICATION

## REF.

## €uros

### Diameter 380mm



- FULLY UPHOLSTERED** Group D
- FULLY UPHOLSTERED** Group C & COF
- FULLY UPHOLSTERED** Group B & Valencia
- FULLY UPHOLSTERED** Group A & COL
- FULLY UPHOLSTERED** Soft leather

Measure: Ø380 0,84ml/11 feet. For projects, please contact the factory.

<b>TP38/D</b>	276
<b>TP38/C</b>	304
<b>TP38/B</b>	362
<b>TP38/A</b>	400
<b>TP38/L</b>	414

### Diameter 450mm

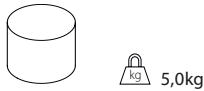

- FULLY UPHOLSTERED** Group D
- FULLY UPHOLSTERED** Group C & COF
- FULLY UPHOLSTERED** Group B & Valencia
- FULLY UPHOLSTERED** Group A & COL
- FULLY UPHOLSTERED** Soft leather

Measure: Ø450 0,84ml/11 feet. For projects, please contact the factory.

<b>TP45/D</b>	322
<b>TP45/C</b>	350
<b>TP45/B</b>	422
<b>TP45/A</b>	478
<b>TP45/L</b>	486

### Diameter 600mm

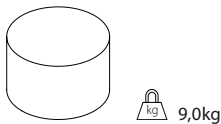

- FULLY UPHOLSTERED** Group D
- FULLY UPHOLSTERED** Group C & COF
- FULLY UPHOLSTERED** Group B & Valencia
- FULLY UPHOLSTERED** Group A & COL
- FULLY UPHOLSTERED** Soft leather

Measure: Ø600 1,30ml/13 feet. For projects, please contact the factory.

<b>TP60/D</b>	408
<b>TP60/C</b>	446
<b>TP60/B</b>	524
<b>TP60/A</b>	582
<b>TP60/L</b>	600

### Diameter 800mm

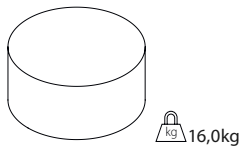

- FULLY UPHOLSTERED** Group D
- FULLY UPHOLSTERED** Group C & COF
- FULLY UPHOLSTERED** Group B & Valencia
- FULLY UPHOLSTERED** Group A & COL
- FULLY UPHOLSTERED** Soft leather

Measure: Ø800 1,62ml/22 feet. For projects, please contact the factory.

<b>TP80/D</b>	578
<b>TP80/C</b>	628
<b>TP80/B</b>	738
<b>TP80/A</b>	826
<b>TP80/L</b>	880

## ACCESSORIES

## DRAWING

## SPECIFICATION

## REF.

## €uros



**PRICE INCREASE FOR FELT** (supplement per pouf)

<b>270/A</b>	14
--------------	----



**PRICE INCREASE FOR CASTORS** Available for pouf of Ø800 (supplement per pouf)

<b>AC027</b>	30
--------------	----

# Topa Table

Pensi Design Studio

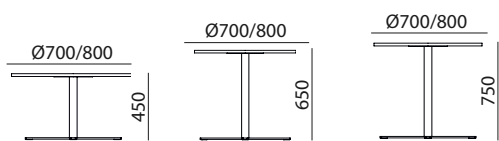

Tables available in 2 diameters and 3 heights. Structure in steel tube Ø500mm and steel base 10mm thick with rubber glides.

Table tops with straight edges in melamine 20mm, compact - HPL 13mm, or varnish wood 20mm. Rounded edges for plywood laminated 20mm.

Type of edges per table top:







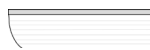

Melamine and wood:  
Straight edges



Compact - HPL:  
Straight edges, black body



Plywood laminated:  
Rounded edges

DRAWING	MEASURES mm	REF.	€uros	REF.	€uros	REF.	€uros	
	<b>Central Column</b>			Melamine 20mm	Plywood laminated 20mm / Compact - HPL 12mm	Wood 20mm		
	H 450mm Ø700mm	 11,5kg	<b>TP01/M</b>	404	<b>TP01/C</b>	544	<b>TP01/W</b>	700
	H 450mm Ø800mm	 12,5kg	<b>TP02/M</b>	414	<b>TP02/C</b>	606	<b>TP02/W</b>	780
	H 650mm Ø700mm	 12,0kg	<b>TP03/M</b>	414	<b>TP03/C</b>	552	<b>TP03/W</b>	708
	H 650mm Ø800mm	 13,0kg	<b>TP04/M</b>	422	<b>TP04/C</b>	612	<b>TP04/W</b>	786
	H 750mm Ø700mm	 12,5kg	<b>TP05/M</b>	422	<b>TP05/C</b>	560	<b>TP05/W</b>	716
H 750mm Ø800mm	 12,5kg	<b>TP06/M</b>	430	<b>TP06/C</b>	622	<b>TP06/W</b>	796	

# Topa

Pensi Design Studio

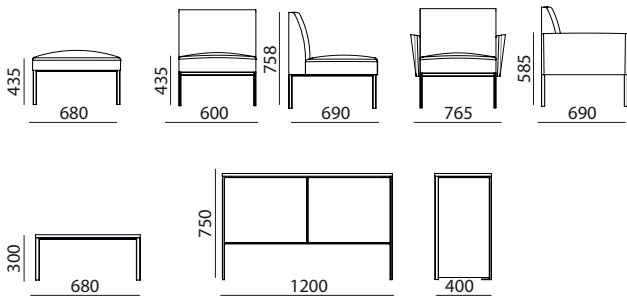

Seats and Sofas



750x750x500mm



1 unit

Sofa made of steel powder coated. Option for only seat, seat and back with or without arms fully upholstered.

Side table with frame made of steel tube powder coated. Table top in melamine, plywood laminated, compact - HPL or wood. Console table with frame made of steel tube powder coated and table top in melamine, plywood laminated or wood.

DRAWING

SPECIFICATION

REF.

€uros

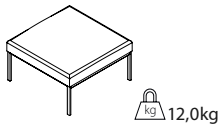

## Seat

- FULLY UPHOLSTERED** Group D
- FULLY UPHOLSTERED** Group C & COF
- FULLY UPHOLSTERED** Group B & Valencia
- FULLY UPHOLSTERED** Group A & COL
- FULLY UPHOLSTERED** Soft leather

<b>TP10/D</b>	494
<b>TP10/C</b>	528
<b>TP10/B</b>	574
<b>TP10/A</b>	650
<b>TP10/L</b>	702

NOTE: THE SEAT IS READY TO JOIN, BUT DOES NOT INCLUDE THE LINKING DEVICE.

Measure: Seat 1,1ml/14 feet. For projects, please contact the factory.

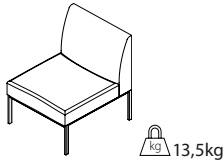

## Sofa Without Arms

- FULLY UPHOLSTERED** Group D
- FULLY UPHOLSTERED** Group C & COF
- FULLY UPHOLSTERED** Group B & Valencia
- FULLY UPHOLSTERED** Group A & COL
- FULLY UPHOLSTERED** Soft leather

<b>TP11/D</b>	804
<b>TP11/C</b>	846
<b>TP11/B</b>	912
<b>TP11/A</b>	1.016
<b>TP11/L</b>	1.196

NOTE: THE SOFA IS READY TO JOIN, BUT DOES NOT INCLUDE THE LINKING DEVICE.

Measure: Sofa without arms 1,5ml/26 feet. For projects, please contact the factory.

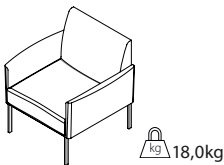

## Sofa With Arms



- FULLY UPHOLSTERED** Group D
- FULLY UPHOLSTERED** Group C & COF
- FULLY UPHOLSTERED** Group B & Valencia
- FULLY UPHOLSTERED** Group A & COL
- FULLY UPHOLSTERED** Soft leather

<b>TP12/D</b>	1.254
<b>TP12/C</b>	1.326
<b>TP12/B</b>	1.440
<b>TP12/A</b>	1.632
<b>TP12/L</b>	2.024

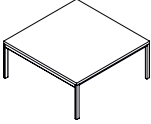
Measure: Sofa with arms 2,7ml/50 feet. For projects, please contact the factory.

DRAWING	MEASURES mm	REF.	€uros	REF.	€uros	REF.	€uros
	<p><b>Side Table</b></p> <p>H 300mm 680x680mm  9,0kg</p>	Melamine 20mm		Plywood laminated 20mm / Compact - HPL 12mm		Wood 20mm	
		<b>TP13/M</b>	256	<b>TP13/C</b>	422	<b>TP13/W</b>	500
NOTE: THE SIDE TABLE IS READY TO JOIN, BUT DOES NOT INCLUDE THE LINKING DEVICE.							
	<p><b>Console Table</b></p> <p>H 750mm 1200x400mm  11,0kg</p>	Melamine 20mm		Plywood laminated 20mm / Compact - HPL 12mm		Wood 20mm	
		<b>TP14/M</b>	472	<b>TP14/C</b>	650	<b>TP14/W</b>	752
NOTE: THE CONSOLE TABLE IS READY TO JOIN, BUT DOES NOT INCLUDE THE LINKING DEVICE.							

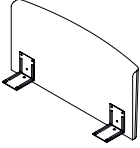
## ACCESSORIES

DRAWING	SPECIFICATION	REF.	€uros
	<b>AMBIDEXTROUS FINAL ARM</b> (supplement per unit) Group D	<b>AC080/D</b>	228
	<b>AMBIDEXTROUS FINAL ARM</b> (supplement per unit) Group C & COF	<b>AC080/C</b>	242
	<b>AMBIDEXTROUS FINAL ARM</b> (supplement per unit) Group B & Valencia	<b>AC080/B</b>	266
	<b>AMBIDEXTROUS FINAL ARM</b> (supplement per unit) Group A & COL	<b>AC080/A</b>	310
	<b>AMBIDEXTROUS FINAL ARM</b> (supplement per unit) Soft leather	<b>AC080/L</b>	418
	<b>LINKING DEVICE</b> Between seat+sofa or sofa+table (includes two pieces per joint)	<b>AC081</b>	26
	<b>ELECTRICAL UNIT</b> White or black 1 schuko+2USB charger	<b>AC082</b>	264

---

# Tknika

Francesc Rifé



Tknika designed by Francesc Rifé, is a new collection of multipurpose tables for the office and home.

A scalable program with multiple applications to meet all the needs of large groups, and that at the same time adapts to create the home office.

# Tknika

Francesc Rifé

## TABLE TOPS

19mm thick table top in melamine with ABS edges, MDF board veneered in natural wood, 20mm black fenix or 12mm compact - HPL.

## WOOD TABLE TOPS

AKABA S.A. will not be responsible for the total uniformity and similarity in the tables that have more than one table top. The nature of this finish, its diversity of veins, tones and shades from one sheet to another, mean that exact uniformity cannot be guaranteed.

## STRUCTURES

Option of legs in painted aluminum, natural beech wood or natural oak.

## JOINTS

Painted aluminum injection joints for direct 90° and 180° legs.

## DISTANCE BETWEEN LEGS (DP)

The distance between legs for the H750mm tables is measured from the height of 450mm.

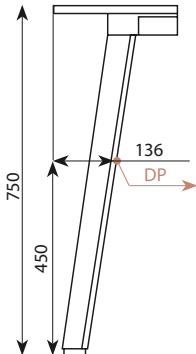

The distance between legs for the H1050mm tables is measured from the height of 750mm.

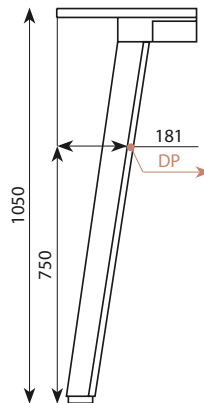

## COLLABORATIVE VERSION (TABLE OVERHANG FOR INTERMEDIATE SUPPORT LEGS)

### TKNIKA COLLABORATIVE H750

Width = / < 1200 distance between the Collaborative legs and the worktop is 228mm.  
Width > 1200 distance between the Collaborative legs and the worktop is 400mm.

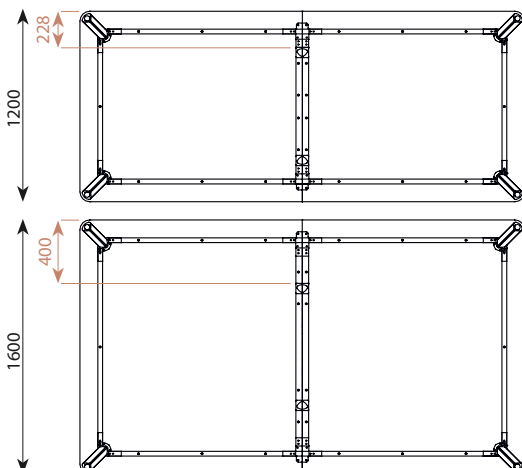





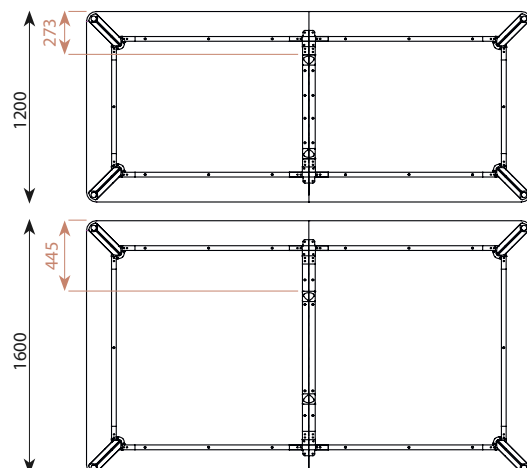



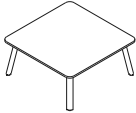

### TKNIKA COLLABORATIVE H1050

Width = / < 1200 distance between the Collaborative legs and the worktop is 273mm.  
Width > 1200 distance between the Collaborative legs and the worktop is 445mm.

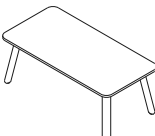

# Tknika Contract-h450











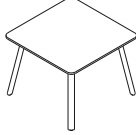

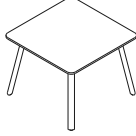



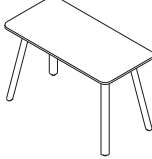

Francesc Rifé

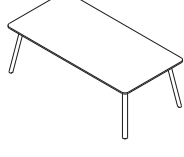
DRAWING	MEASURES mm	REF. Euros	REF. Euros	REF. Euros	REF. Euros	REF. Euros	REF. Euros
	<b>Square</b>	Melamine 19mm	Compact - HPL 12mm (*)	Wood 19mm	Black Fenix 20mm (*)	Beech legs supplement	Oak legs supplement
	900x900mm  13kg	<b>T001/M</b> 710	<b>T001/C</b> 734	<b>T001/W</b> 960	<b>T001/F</b> 1.067	<b>+WL4</b> 72	<b>+OL4</b> 348
	1000x1000mm  17kg	<b>T002/M</b> 729	<b>T002/C</b> 792	<b>T002/W</b> 1.042	<b>T002/F</b> 1.164	<b>+WL4</b> 72	<b>+OL4</b> 348
	1100x1100mm  26kg	<b>T003/M</b> 1.059	<b>T003/C</b> 1.130	<b>T003/W</b> 1.419	<b>T003/F</b> 1.587	<b>+WL4</b> 72	<b>+OL4</b> 348
	<b>Rectangular</b>	Melamine 19mm	Compact - HPL 12mm (*)	Wood 19mm	Black Fenix 20mm (*)	Beech legs supplement	Oak legs supplement
	1200x600mm  10kg	<b>T004/M</b> 705	<b>T004/C</b> 707	<b>T004/W</b> 926	<b>T004/F</b> 1.021	<b>+WL4</b> 72	<b>+OL4</b> 348
	<b>Round</b>	Melamine 19mm	Compact - HPL 12mm (*)	Wood 19mm	Black Fenix 20mm (*)	Beech legs supplement	Oak legs supplement
	Ø900mm  11kg	<b>T005/M</b> 556	<b>T005/C</b> 625	<b>T005/W</b> 741	<b>T005/F</b> 962	<b>+WL3</b> 55	<b>+OL3</b> 261
	Ø1000mm  13kg	<b>T006/M</b> 571	<b>T006/C</b> 680	<b>T006/W</b> 812	<b>T006/F</b> 1.059	<b>+WL3</b> 55	<b>+OL3</b> 261
Ø1100mm  17kg	<b>T007/M</b> 880	<b>T007/C</b> 1.011	<b>T007/W</b> 1.137	<b>T007/F</b> 1.485	<b>+WL3</b> 55	<b>+OL3</b> 261	

(\*) COMPACT - HPL TABLE TOP MAXIMUM SIZE FOR ONE PIECE 2400X1800mm. FENIX TABLE TOP MAXIMUM WIDTH 1200mm.

# Tknika Contract-h750

Francesc Rifé











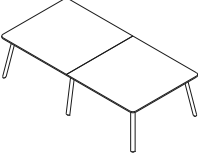







DRAWING	MEASURES mm	REF. Euros	REF. Euros	REF. Euros	REF. Euros	REF. Euros	REF. Euros
	<b>Square</b> <b>Direct Leg</b>	Melamine 19mm	Compact - HPL 12mm (*)	Wood 19mm	Black Fenix 20mm (*)	Beech legs supplement	Oak legs supplement
	900x900mm DP 628/628mm  15kg	<b>T010/M</b> 710	<b>T010/C</b> 734	<b>T010/W</b> 960	<b>T010/F</b> 1.067	<b>+WL4</b> 72	<b>+OL4</b> 348
	1000x1000mm DP 728/728mm  18kg	<b>T011/M</b> 729	<b>T011/C</b> 792	<b>T011/W</b> 1.042	<b>T011/F</b> 1.164	<b>+WL4</b> 72	<b>+OL4</b> 348
	<b>Square</b>	Melamine 19mm	Compact - HPL 12mm (*)	Wood 19mm	Black Fenix 20mm (*)	Beech legs supplement	Oak legs supplement
	1100x1100mm DP 828/828mm  27kg	<b>T012/M</b> 1.059	<b>T012/C</b> 1.130	<b>T012/W</b> 1.419	<b>T012/F</b> 1.587	<b>+WL4</b> 72	<b>+OL4</b> 348
	1200x1200mm DP 928/928mm  30kg	<b>T013/M</b> 1.091	<b>T013/C</b> 1.213	<b>T013/W</b> 1.531	<b>T013/F</b> 1.718	<b>+WL4</b> 72	<b>+OL4</b> 348
	1400x1400mm DP 1128/1128mm  38kg	<b>T014/M</b> 1.249	<b>T014/C</b> 1.446	<b>T014/W</b> 1.866		<b>+WL4</b> 72	<b>+OL4</b> 348
	1600x1600mm DP 1328/1328mm  47kg	<b>T015/M</b> 1.327	<b>T015/C</b> 1.652	<b>T015/W</b> 2.143		<b>+WL4</b> 72	<b>+OL4</b> 348
	1800x1800mm DP 1528/1528mm  57kg	<b>T016/M</b> 1.494	<b>T016/C</b> 1.956	<b>T016/W</b> 2.532		<b>+WL4</b> 72	<b>+OL4</b> 348
	<b>Rectangular</b> <b>Direct Leg</b>	Melamine 19mm	Compact - HPL 12mm (*)	Wood 19mm	Black Fenix 20mm (*)	Beech legs supplement	Oak legs supplement
	1200x600mm DP 928/328mm  14kg	<b>T020/M</b> 705	<b>T020/C</b> 707	<b>T020/W</b> 926	<b>T020/F</b> 1.021	<b>+WL4</b> 72	<b>+OL4</b> 348
	<b>Rectangular</b>	Melamine 19mm	Compact - HPL 12mm (*)	Wood 19mm	Black Fenix 20mm (*)	Beech legs supplement	Oak legs supplement
	1400x700mm DP 1128/428mm  23kg	<b>T021/M</b> 914	<b>T021/C</b> 953	<b>T021/W</b> 1.208	<b>T021/F</b> 1.341	<b>+WL4</b> 72	<b>+OL4</b> 348
	1600x800mm DP 1328/528mm  28kg	<b>T022/M</b> 960	<b>T022/C</b> 1.062	<b>T022/W</b> 1.354	<b>T022/F</b> 1.519	<b>+WL4</b> 72	<b>+OL4</b> 348
	1800x900mm DP 1528/628mm  34kg	<b>T023/M</b> 1.050	<b>T023/C</b> 1.217	<b>T023/W</b> 1.555	<b>T023/F</b> 1.754	<b>+WL4</b> 72	<b>+OL4</b> 348
	2000x1000mm DP 1728/728mm  39kg	<b>T024/M</b> 1.108	<b>T024/C</b> 1.358	<b>T024/W</b> 1.742	<b>T024/F</b> 1.976	<b>+WL4</b> 72	<b>+OL4</b> 348
	2200x1100mm DP 1928/828mm  46kg	<b>T025/M</b> 1.375	<b>T025/C</b> 1.686	<b>T025/W</b> 2.129	<b>T025/F</b> 2.420	<b>+WL4</b> 72	<b>+OL4</b> 348
	2400x1200mm DP 2128/928mm  53kg	<b>T026/M</b> 1.446	<b>T026/C</b> 1.854	<b>T026/W</b> 2.313	<b>T026/F</b> 2.690	<b>+WL4</b> 72	<b>+OL4</b> 348
	2600x1200mm DP 2328/928mm  65kg	<b>T027/M</b> 1.750		<b>T027/W</b> 2.671	<b>T027/F</b> 3.093	<b>+WL4</b> 72	<b>+OL4</b> 348
2800x1200mm DP 2528/928mm  70kg	<b>T028/M</b> 1.796		<b>T028/W</b> 2.797	<b>T028/F</b> 3.246	<b>+WL4</b> 72	<b>+OL4</b> 348	

(\*) COMPACT - HPL TABLE TOP MAXIMUM SIZE FOR ONE PIECE 2400X1800mm. FENIX TABLE TOP MAXIMUM WIDTH 1200mm.

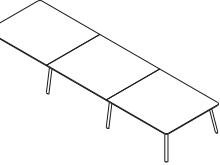

# Tknika Contract-h750















Francesc Rifé

DRAWING	MEASURES mm	REF. Euros	REF. Euros	REF. Euros	REF. Euros	REF. Euros	REF. Euros	
	<b>Rectangular 2 Table Tops</b>	Melamine 19mm	Compact - HPL 12mm (*)	Wood 19mm	Black Fenix 20mm (*)	Beech legs supplement	Oak legs supplement	
	2800x1400mm DP 2x1229/1128mm  74kg	<b>T030/M</b> 2.628	<b>T030/C</b> 3.146	<b>T030/W</b> 3.729		<b>+WL6</b> 108	<b>+OL6</b> 522	
	2800x1600mm DP 2x1229/1328mm  82kg	<b>T031/M</b> 2.727	<b>T031/C</b> 3.387	<b>T031/W</b> 4.015		<b>+WL6</b> 108	<b>+OL6</b> 522	
	3200x1200mm DP 2x1429/928mm  73kg	<b>T032/M</b> 2.404	<b>T032/C</b> 2.916	<b>T032/W</b> 3.395	<b>T032/F</b> 4.234	<b>+WL6</b> 108	<b>+OL6</b> 522	
	3200x1400mm DP 2x1429/1128mm  82kg	<b>T033/M</b> 2.684	<b>T033/C</b> 3.269	<b>T033/W</b> 3.871		<b>+WL6</b> 108	<b>+OL6</b> 522	
	3600x1200mm DP 2x1729/928mm  80kg	<b>T034/M</b> 2.585	<b>T034/C</b> 3.197	<b>T034/W</b> 3.710	<b>T034/F</b> 4.640	<b>+WL6</b> 108	<b>+OL6</b> 522	
	3600x1400mm DP 2x1729/1128mm  91kg	<b>T035/M</b> 2.882	<b>T035/C</b> 3.585	<b>T035/W</b> 4.232		<b>+WL6</b> 108	<b>+OL6</b> 522	
	3600x1600mm DP 2x1729/1328mm  101kg	<b>T036/M</b> 2.991	<b>T036/C</b> 3.862	<b>T036/W</b> 4.568		<b>+WL6</b> 108	<b>+OL6</b> 522	
	3800x1400mm DP 2x1729/1128mm  95kg	<b>T037/M</b> 2.924	<b>T037/C</b> 3.692	<b>T037/W</b> 4.363		<b>+WL6</b> 108	<b>+OL6</b> 522	
	3800x1600mm DP 2x1729/1328mm  105kg	<b>T038/M</b> 3.039	<b>T038/C</b> 3.985	<b>T038/W</b> 4.720		<b>+WL6</b> 108	<b>+OL6</b> 522	
	4000x1400mm DP 2x1829/1128mm  99kg	<b>T039/M</b> 2.967	<b>T039/C</b> 3.801	<b>T039/W</b> 4.496		<b>+WL6</b> 108	<b>+OL6</b> 522	
	4000x1600mm DP 2x1829/1328mm  110kg	<b>T040/M</b> 3.088	<b>T040/C</b> 4.105	<b>T040/W</b> 4.870		<b>+WL6</b> 108	<b>+OL6</b> 522	
	4200x1400mm DP 2x1929/1128mm  103kg	<b>T041/M</b> 3.170	<b>T041/C</b> 4.049	<b>T041/W</b> 4.761		<b>+WL6</b> 108	<b>+OL6</b> 522	
	4200x1600mm DP 2x1929/1328mm  115kg	<b>T042/M</b> 3.293	<b>T042/C</b> 4.368	<b>T042/W</b> 5.154		<b>+WL6</b> 108	<b>+OL6</b> 522	
		<b>Rectangular 3 Table Tops</b>	Melamine 19mm	Compact - HPL 12mm (*)	Wood 19mm	Black Fenix 20mm (*)	Beech legs supplement	Oak legs supplement
		5400x1400mm DP 3x1729/1128mm  134kg	<b>T080/M</b> 4.239	<b>T080/C</b> 5.306	<b>T080/W</b> 6.277		<b>+WL8</b> 144	<b>+OL8</b> 696
		5400x1600mm DP 3x1729/1328mm  150kg	<b>T081/M</b> 4.411	<b>T081/C</b> 5.728	<b>T081/W</b> 6.789		<b>+WL8</b> 144	<b>+OL8</b> 696
6000x1400mm DP 3x1829/1128mm  147kg		<b>T082/M</b> 4.357	<b>T082/C</b> 5.619	<b>T082/W</b> 6.666		<b>+WL8</b> 144	<b>+OL8</b> 696	
6000x1600mm DP 3x1829/1328mm  164kg		<b>T083/M</b> 4.536	<b>T083/C</b> 6.075	<b>T083/W</b> 7.225		<b>+WL8</b> 144	<b>+OL8</b> 696	

(\*) COMPACT - HPL TABLE TOP MAXIMUM SIZE FOR ONE PIECE 2400X1800mm. FENIX TABLE TOP MAXIMUM WIDTH 1200mm.

# Tknika Contract-h750

Francesc Rifé

DRAWING	MEASURES mm	REF.	€uros	REF.	€uros	REF.	€uros	REF.	€uros	REF.	€uros	REF.	€uros	
	<b>Round 3 Legs</b> <b>Direct Leg</b>		Melamine 19mm	Compact - HPL 12mm (*)	Wood 19mm	Black Fenix 20mm (*)	Beech legs supplement	Oak legs supplement						
	Ø900mm DP 543mm	 12kg	<b>T050/M</b>	556	<b>T050/C</b>	625	<b>T050/W</b>	741	<b>T050/F</b>	962	<b>+WL3</b>	55	<b>+OL3</b>	261
	Ø1000mm DP 607mm	 14kg	<b>T051/M</b>	571	<b>T051/C</b>	680	<b>T051/W</b>	812	<b>T051/F</b>	1.059	<b>+WL3</b>	55	<b>+OL3</b>	261
	<b>Round 3 Legs</b>		Melamine 19mm	Compact - HPL 12mm (*)	Wood 19mm	Black Fenix 20mm (*)	Beech legs supplement	Oak legs supplement						
	Ø1100mm DP 670mm	 18kg	<b>T052/M</b>	880	<b>T052/C</b>	1.011	<b>T052/W</b>	1.137	<b>T052/F</b>	1.485	<b>+WL3</b>	55	<b>+OL3</b>	261
	Ø1200mm DP 734mm	 18kg	<b>T053/M</b>	897	<b>T053/C</b>	1.079	<b>T053/W</b>	1.222	<b>T053/F</b>	1.604	<b>+WL3</b>	55	<b>+OL3</b>	261
	Ø1400mm DP 861mm	 18kg	<b>T054/M</b>	1.016	<b>T054/C</b>	1.281	<b>T054/W</b>	1.487			<b>+WL3</b>	55	<b>+OL3</b>	261
	Ø1600mm DP 988mm	 19kg	<b>T055/M</b>	1.059	<b>T055/C</b>	1.458	<b>T055/W</b>	1.703			<b>+WL3</b>	55	<b>+OL3</b>	261
	ATTENTION Ø1600mm IS THE MAXIMUM MEASUREMENT FOR 3 LEGS.													
	<b>Round 4 Legs</b> <b>Direct Leg</b>		Melamine 19mm	Compact - HPL 12mm (*)	Wood 19mm	Black Fenix 20mm (*)	Beech legs supplement	Oak legs supplement						
	Ø1000mm DP 435mm	 15kg	<b>T056/M</b>	668	<b>T056/C</b>	768	<b>T056/W</b>	892	<b>T056/F</b>	1.164	<b>+WL4</b>	72	<b>+OL4</b>	348
	Ø1200mm DP 577mm	 19kg	<b>T057/M</b>	807	<b>T057/C</b>	996	<b>T057/W</b>	1.145	<b>T057/F</b>	1.504	<b>+WL4</b>	72	<b>+OL4</b>	348
	(*) COMPACT - HPL TABLE TOP MAXIMUM SIZE FOR ONE PIECE 2400X1800mm. FENIX TABLE TOP MAXIMUM WIDTH 1200mm.													
	<b>Round 4 Legs</b>		Melamine 19mm	Compact - HPL 12mm (*)	Wood 19mm	Black Fenix 20mm (*)	Beech legs supplement	Oak legs supplement						
	Ø1400mm DP 718mm	 29kg	<b>T058/M</b>	1.108	<b>T058/C</b>	1.366	<b>T058/W</b>	1.565			<b>+WL4</b>	72	<b>+OL4</b>	348
	Ø1600mm DP 860mm	 30kg	<b>T059/M</b>	1.164	<b>T059/C</b>	1.555	<b>T059/W</b>	1.793			<b>+WL4</b>	72	<b>+OL4</b>	348
	Ø1800mm DP 1001mm	 31kg	<b>T060/M</b>	1.281	<b>T060/C</b>	1.813	<b>T060/W</b>	2.097			<b>+WL4</b>	72	<b>+OL4</b>	348
	NOTE: THE MAXIMUM SIZE AVAILABLE WITH 4 LEGS IS Ø2000mm. CONTACT WITH FACTORY FOR PRICE AND AVAILABILITY. (*) COMPACT - HPL TABLE TOP MAXIMUM SIZE FOR ONE PIECE 2400X1800mm. FENIX TABLE TOP MAXIMUM WIDTH 1200mm.													

# Tknika Contract-h1050

Francesc Rifé



DRAWING	MEASURES mm	REF. Euros	REF. Euros	REF. Euros	REF. Euros	REF. Euros	REF. Euros
	<b>Square Direct Leg</b>	Melamine 19mm	Compact - HPL 12mm (*)	Wood 19mm	Black Fenix 20mm (*)	Beech legs supplement	Oak legs supplement
	900x900mm DP 538x538mm	<b>T100/M</b> 785	<b>T100/C</b> 797	<b>T100/W</b> 1.028	<b>T100/F</b> 1.140	<b>+WL4</b> 72	<b>+SL4</b> 470
	1000x1000mm DP 638/638mm	<b>T101/M</b> 799	<b>T101/C</b> 858	<b>T101/W</b> 1.111	<b>T101/F</b> 1.237	<b>+WL4</b> 72	<b>+SL4</b> 470
	<b>Square</b>	Melamine 19mm	Compact - HPL 12mm (*)	Wood 19mm	Black Fenix 20mm (*)	Beech legs supplement	Oak legs supplement
	1100x1100mm DP 738/738mm	<b>T102/M</b> 1.120	<b>T102/C</b> 1.183	<b>T102/W</b> 1.475	<b>T102/F</b> 1.648	<b>+WL4</b> 72	<b>+SL4</b> 470
	1200x1200mm DP 838/838mm	<b>T103/M</b> 1.154	<b>T103/C</b> 1.266	<b>T103/W</b> 1.587	<b>T103/F</b> 1.779	<b>+WL4</b> 72	<b>+SL4</b> 470
	1400x1400mm DP 1038/1038mm	<b>T104/M</b> 1.310	<b>T104/C</b> 1.499	<b>T104/W</b> 1.922		<b>+WL4</b> 72	<b>+SL4</b> 470
	1600x1600mm DP 1238/1238mm	<b>T105/M</b> 1.409	<b>T105/C</b> 1.720	<b>T105/W</b> 2.219		<b>+WL4</b> 72	<b>+SL4</b> 470
	<b>Rectangular</b>	Melamine 19mm	Compact - HPL 12mm (*)	Wood 19mm	Black Fenix 20mm (*)	Beech legs supplement	Oak legs supplement
	1400x700mm DP 1038/338mm	<b>T111/M</b> 974	<b>T111/C</b> 1.004	<b>T111/W</b> 1.261	<b>T111/F</b> 1.405	<b>+WL4</b> 72	<b>+SL4</b> 470
	1600x800mm DP 1238/438mm	<b>T112/M</b> 1.033	<b>T112/C</b> 1.123	<b>T112/W</b> 1.419	<b>T112/F</b> 1.589	<b>+WL4</b> 72	<b>+SL4</b> 470
	1800x900mm DP 1438/538mm	<b>T113/M</b> 1.115	<b>T113/C</b> 1.276	<b>T113/W</b> 1.616	<b>T113/F</b> 1.823	<b>+WL4</b> 72	<b>+SL4</b> 470
	2000x900mm DP 1638/538mm	<b>T114/M</b> 1.145	<b>T114/C</b> 1.341	<b>T114/W</b> 1.706	<b>T114/F</b> 1.927	<b>+WL4</b> 72	<b>+SL4</b> 470
	2200x900mm DP 1838/538mm	<b>T115/M</b> 1.208		<b>T115/W</b> 1.825	<b>T115/F</b> 2.066	<b>+WL4</b> 72	<b>+SL4</b> 470
	<b>Rectangular 2 Table Tops</b>	Melamine 19mm	Compact - HPL 12mm (*)	Wood 19mm	Black Fenix 20mm (*)	Beech legs supplement	Oak legs supplement
	2600x1200mm DP 2x1084/838mm	<b>T120/M</b> 2.366	<b>T120/C</b> 2.697	<b>T120/W</b> 3.112	<b>T120/F</b> 3.854	<b>+WL6</b> 108	<b>+SL6</b> 705
	2800x1200mm DP 2x1184/838mm	<b>T121/M</b> 2.404	<b>T121/C</b> 2.791	<b>T121/W</b> 3.226	<b>T121/F</b> 4.004	<b>+WL6</b> 108	<b>+SL6</b> 705
	3200x1200mm DP 2x1384/838mm	<b>T122/M</b> 2.501	<b>T122/C</b> 2.996	<b>T122/W</b> 3.475	<b>T122/F</b> 4.331	<b>+WL6</b> 108	<b>+SL6</b> 705
	3600x1200mm DP 2x1584/838mm	<b>T123/M</b> 2.684	<b>T123/C</b> 3.280	<b>T123/W</b> 3.793	<b>T123/F</b> 4.739	<b>+WL6</b> 108	<b>+SL6</b> 705



ATTENTION FROM 2400mm IT WILL BE MANUFACTURED IN 2 TABLE TOPS.



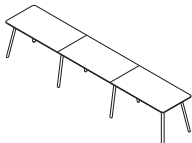

(\*) COMPACT - HPL TABLE TOP MAXIMUM SIZE FOR ONE PIECE 2400X1800mm. FENIX TABLE TOP MAXIMUM WIDTH 1200mm.

# Tknika Contract-h1050



Francesc Rifé

DRAWING	MEASURES mm	REF. Euros	REF. Euros	REF. Euros	REF. Euros	REF. Euros	REF. Euros
	<b>Rectangular 3 Table Tops</b>	Melamine 19mm	Compact - HPL 12mm (*)	Wood 19mm	Black Fenix 20mm (*)	Beech legs supplement	Oak legs supplement
	5400x1000mm DP 3x1584/638mm  106kg	<b>T124/M</b> 3.285	<b>T124/C</b> 3.996	<b>T124/W</b> 4.701	<b>T124/F</b> 5.862	<b>+WL6</b> 108	<b>+SL6</b> 705

DRAWING	MEASURES mm	REF. Euros	REF. Euros	REF. Euros	REF. Euros	REF. Euros	REF. Euros
	<b>Round 3 Legs Direct Leg</b>	Melamine 19mm	Compact - HPL 12mm (*)	Wood 19mm	Black Fenix 20mm (*)	Beech legs supplement	Oak legs supplement
	Ø900mm DP 480mm  13kg	<b>T140/M</b> 661	<b>T140/C</b> 668	<b>T140/W</b> 775	<b>T140/F</b> 1.018	<b>+WL3</b> 55	<b>+SL3</b> 353
	Ø1000mm DP 543,6mm  15kg	<b>T141/M</b> 678	<b>T141/C</b> 727	<b>T141/W</b> 846	<b>T141/F</b> 1.113	<b>+WL3</b> 55	<b>+SL3</b> 353





DRAWING	MEASURES mm	REF. Euros	REF. Euros	REF. Euros	REF. Euros	REF. Euros	REF. Euros
	<b>Round 3 Legs</b>	Melamine 19mm	Compact - HPL 12mm (*)	Wood 19mm	Black Fenix 20mm (*)	Beech legs supplement	Oak legs supplement
	Ø1100mm DP 607,2mm  19kg	<b>T142/M</b> 1.013	<b>T142/C</b> 1.057	<b>T142/W</b> 1.162	<b>T142/F</b> 1.541	<b>+WL3</b> 55	<b>+SL3</b> 353
	Ø1200mm DP 670,8mm  21kg	<b>T143/M</b> 1.033	<b>T143/C</b> 1.125	<b>T143/W</b> 1.244	<b>T143/F</b> 1.657	<b>+WL3</b> 55	<b>+SL3</b> 353
	Ø1400mm DP 798mm  27kg	<b>T144/M</b> 1.162	<b>T144/C</b> 1.327	<b>T144/W</b> 1.509		<b>+WL3</b> 55	<b>+SL3</b> 353

NOTE: THE MAXIMUM SIZE AVAILABLE WITH 3 LEGS IS Ø1600mm. CONTACT WITH FACTORY FOR PRICE AND AVAILABILITY.

DRAWING	MEASURES mm	REF. Euros	REF. Euros	REF. Euros	REF. Euros	REF. Euros	REF. Euros
	<b>Round 4 Legs Direct Leg</b>	Melamine 19mm	Compact - HPL 12mm (*)	Wood 19mm	Black Fenix 20mm (*)	Beech legs supplement	Oak legs supplement
	Ø1100mm DP 416mm  18kg	<b>T145/M</b> 933	<b>T145/C</b> 989	<b>T145/W</b> 1.098	<b>T145/F</b> 1.460	<b>+WL4</b> 72	<b>+SL4</b> 470
	Ø1200mm DP 487mm  21kg	<b>T146/M</b> 953	<b>T146/C</b> 1.057	<b>T146/W</b> 1.183	<b>T146/F</b> 1.577	<b>+WL4</b> 72	<b>+SL4</b> 470

FOR OTHER CONFIGURATIONS OF H1050 CONTACT FACTORY FOR PRICE AND AVAILABILITY.

(\*) COMPACT - HPL TABLE TOP MAXIMUM SIZE FOR ONE PIECE 2400X1800mm. FENIX TABLE TOP MAXIMUM WIDTH 1200mm.

DRAWING	MEASURES mm	REF. Euros	REF. Euros	REF. Euros	REF. Euros	REF. Euros	REF. Euros
	<b>Round 4 Legs</b>	Melamine 19mm	Compact - HPL 12mm (*)	Wood 19mm	Black Fenix 20mm (*)	Beech legs supplement	Oak legs supplement
	Ø1400mm DP 628mm  29kg	<b>T147/M</b> 1.261	<b>T147/C</b> 1.412	<b>T147/W</b> 1.589		<b>+WL4</b> 72	<b>+SL4</b> 470
	Ø1600mm DP 770mm  36kg	<b>T148/M</b> 1.337	<b>T148/C</b> 1.606	<b>T148/W</b> 1.825		<b>+WL4</b> 72	<b>+SL4</b> 470
	Ø1800mm DP 911mm  44kg	<b>T149/M</b> 1.458	<b>T149/C</b> 1.864	<b>T149/W</b> 2.117		<b>+WL4</b> 72	<b>+SL4</b> 470











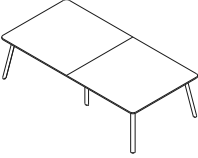



NOTE: THE MAXIMUM SIZE AVAILABLE WITH 4 LEGS IS Ø2000mm. CONSULT WITH FACTORY PRICE AND AVAILABILITY.

FOR OTHER CONFIGURATIONS OF H1050 CONSULT FACTORY PRICE AND AVAILABILITY.





(\*) COMPACT - HPL TABLE TOP MAXIMUM SIZE FOR ONE PIECE 2400X1800mm. FENIX TABLE TOP MAXIMUM WIDTH 1200mm.

# Tknika Collaborative-h750

Francesc Rifé

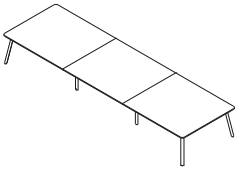
DRAWING	MEASURES mm	REF. Euros	REF. Euros	REF. Euros	REF. Euros	REF. Euros	REF. Euros
	<b>Rectangular 2 Table Tops</b>	Melamine 19mm	Compact - HPL 12mm (*)	Wood 19mm	Black Fenix 20mm (*)	Beech legs supplement	Oak legs supplement
	2800x1400mm E 1400/1400mm (2)  74kg	<b>T200/M</b> 2.628	<b>T200/C</b> 3.146	<b>T200/W</b> 3.729		<b>+WL6</b> 108	<b>+OL6</b> 522
	2800x1600mm E 1400/1600mm (2)  82kg	<b>T201/M</b> 2.727	<b>T201/C</b> 3.387	<b>T201/W</b> 4.015		<b>+WL6</b> 108	<b>+OL6</b> 522
	3200x1200mm E 1600/1200mm (2)  73kg	<b>T202/M</b> 2.404	<b>T202/C</b> 2.916	<b>T202/W</b> 3.395	<b>T202/F</b> 4.234	<b>+WL6</b> 108	<b>+OL6</b> 522
	3200x1400mm E 1600/1400mm (2)  82kg	<b>T203/M</b> 2.684	<b>T203/C</b> 3.269	<b>T203/W</b> 3.871		<b>+WL6</b> 108	<b>+OL6</b> 522
	3600x1200mm E 1800/1200mm (2)  80kg	<b>T204/M</b> 2.585	<b>T204/C</b> 3.197	<b>T204/W</b> 3.710	<b>T204/F</b> 4.640	<b>+WL6</b> 108	<b>+OL6</b> 522
	3600x1400mm E 1800/1400mm (2)  91kg	<b>T205/M</b> 2.882	<b>T205/C</b> 3.585	<b>T205/W</b> 4.232		<b>+WL6</b> 108	<b>+OL6</b> 522
	3600x1600mm E 1800/1600mm (2)  101kg	<b>T206/M</b> 2.991	<b>T206/C</b> 3.862	<b>T206/W</b> 4.568		<b>+WL6</b> 108	<b>+OL6</b> 522
	3800x1400mm E 1900/1400mm (2)  95kg	<b>T207/M</b> 2.924	<b>T207/C</b> 3.692	<b>T207/W</b> 4.363		<b>+WL6</b> 108	<b>+OL6</b> 522
	3800x1600mm E 1900/1600mm (2)  105kg	<b>T208/M</b> 3.039	<b>T208/C</b> 3.985	<b>T208/W</b> 4.720		<b>+WL6</b> 108	<b>+OL6</b> 522
	4000x1400mm E 2000/1400mm (2)  99kg	<b>T209/M</b> 2.967	<b>T209/C</b> 3.801	<b>T209/W</b> 4.496		<b>+WL6</b> 108	<b>+OL6</b> 522
	4000x1600mm E 2000/1600mm (2)  110kg	<b>T210/M</b> 3.088	<b>T210/C</b> 4.105	<b>T210/W</b> 4.870		<b>+WL6</b> 108	<b>+OL6</b> 522
	4200x1400mm E 2100/1400mm (2)  103kg	<b>T211/M</b> 3.170	<b>T211/C</b> 4.049	<b>T211/W</b> 4.761		<b>+WL6</b> 108	<b>+OL6</b> 522
	4200x1600mm E 2100/1600mm (2)  115kg	<b>T212/M</b> 3.293	<b>T212/C</b> 4.368	<b>T212/W</b> 5.154		<b>+WL6</b> 108	<b>+OL6</b> 522











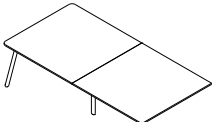



NOTE: THE MAXIMUM LENGTH PER TABLE TOP IS 2100mm.

	<b>Rectangular 3 Table Tops</b>	Melamine 19mm	Compact - HPL 12mm (*)	Wood 19mm	Black Fenix 20mm (*)	Beech legs supplement	Oak legs supplement
	5400x1400mm E 1800/1400mm (3)  134kg	<b>T300/M</b> 5.133	<b>T300/C</b> 6.417	<b>T300/W</b> 7.597		<b>+WL8</b> 144	<b>+OL8</b> 696
	5400x1600mm E 1800/1600mm (3)  150kg	<b>T301/M</b> 5.338	<b>T301/C</b> 6.933	<b>T301/W</b> 8.219		<b>+WL8</b> 144	<b>+OL8</b> 696
	6000x1400mm E 2000/1400mm (3)  147kg	<b>T302/M</b> 5.273	<b>T302/C</b> 6.800	<b>T302/W</b> 8.067		<b>+WL8</b> 144	<b>+OL8</b> 696
	6000x1600mm E 2000/1600mm (3)  164kg	<b>T303/M</b> 5.490	<b>T303/C</b> 7.351	<b>T303/W</b> 8.744		<b>+WL8</b> 144	<b>+OL8</b> 696



(\*) COMPACT - HPL TABLE TOP MAXIMUM SIZE FOR ONE PIECE 2400X1800mm. FENIX TABLE TOP MAXIMUM WIDTH 1200mm.  
NOTE: THE MAXIMUM LENGTH PER TABLE TOP IS 2100mm.

# Tknika Collaborative-h750



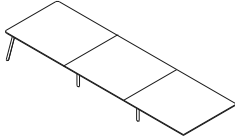

Francesc Rifé

DRAWING	MEASURES mm	REF. Euros	REF. Euros	REF. Euros	REF. Euros	REF. Euros	REF. Euros
	<b>Rectangular 2 Table Tops + Termination (*)</b>	Melamine 19mm	Compact - HPL 12mm (*)	Wood 19mm	Black Fenix 20mm (*)	Beech legs supplement	Oak legs supplement
	2800x1400mm E 1400/1400mm (2)  74kg	<b>T250/M</b> 2.344	<b>T250/C</b> 2.866	<b>T250/W</b> 3.445		<b>+WL6</b> 108	<b>+OL6</b> 522
	2800x1600mm E 1400/1600mm (2)  82kg	<b>T251/M</b> 2.435	<b>T251/C</b> 3.095	<b>T251/W</b> 3.726		<b>+WL6</b> 108	<b>+OL6</b> 522
	3200x1200mm E 1600/1200mm (2)  73kg	<b>T252/M</b> 2.127	<b>T252/C</b> 2.638	<b>T252/W</b> 3.120	<b>T252/F</b> 3.956	<b>+WL6</b> 108	<b>+OL6</b> 522
	3200x1400mm E 1600/1400mm (2)  82kg	<b>T253/M</b> 2.400	<b>T253/C</b> 2.985	<b>T253/W</b> 3.587		<b>+WL6</b> 108	<b>+OL6</b> 522
	3600x1200mm E 1800/1200mm (2)  80kg	<b>T254/M</b> 2.310	<b>T254/C</b> 2.922	<b>T254/W</b> 3.435	<b>T254/F</b> 4.365	<b>+WL6</b> 108	<b>+OL6</b> 522
	3600x1400mm E 1800/1400mm (2)  91kg	<b>T255/M</b> 2.598	<b>T255/C</b> 3.301	<b>T255/W</b> 3.948		<b>+WL6</b> 108	<b>+OL6</b> 522
	3600x1600mm E 1800/1600mm (2)  101kg	<b>T256/M</b> 2.699	<b>T256/C</b> 3.574	<b>T256/W</b> 4.279		<b>+WL6</b> 108	<b>+OL6</b> 522
	3800x1400mm E 1900/1400mm (2)  95kg	<b>T257/M</b> 2.643	<b>T257/C</b> 3.411	<b>T257/W</b> 4.082		<b>+WL6</b> 108	<b>+OL6</b> 522
	3800x1600mm E 1900/1600mm (2)  105kg	<b>T258/M</b> 2.748	<b>T258/C</b> 3.697	<b>T258/W</b> 4.432		<b>+WL6</b> 108	<b>+OL6</b> 522
	4000x1400mm E 2000/1400mm (2)  99kg	<b>T259/M</b> 2.686	<b>T259/C</b> 3.518	<b>T259/W</b> 4.213		<b>+WL6</b> 108	<b>+OL6</b> 522
	4000x1600mm E 2000/1600mm (2)  110kg	<b>T260/M</b> 2.798	<b>T260/C</b> 3.815	<b>T260/W</b> 4.582		<b>+WL6</b> 108	<b>+OL6</b> 522
	4200x1400mm E 2100/1400mm (2)  103kg	<b>T261/M</b> 2.890	<b>T261/C</b> 3.766	<b>T261/W</b> 4.480		<b>+WL6</b> 108	<b>+OL6</b> 522
	4200x1600mm E 2100/1600mm (2)  115kg	<b>T262/M</b> 3.004	<b>T262/C</b> 4.079	<b>T262/W</b> 4.862		<b>+WL6</b> 108	<b>+OL6</b> 522

NOTE: THE MAXIMUM LENGTH PER TABLE TOP IS 2100mm.

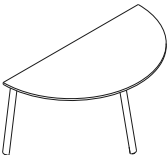
DRAWING	MEASURES mm	REF. Euros	REF. Euros	REF. Euros	REF. Euros	REF. Euros	REF. Euros
	<b>Rectangular 3 Table Tops + Termination (*)</b>	Melamine 19mm	Compact - HPL 12mm (*)	Wood 19mm	Black Fenix 20mm (*)	Beech legs supplement	Oak legs supplement
	5400x1400mm E 1800/1400mm (3)  134kg	<b>T350/M</b> 4.849	<b>T350/C</b> 6.137	<b>T350/W</b> 7.313		<b>+WL8</b> 144	<b>+OL8</b> 696
	5400x1600mm E 1800/1600mm (3)  150kg	<b>T351/M</b> 5.047	<b>T351/C</b> 6.643	<b>T351/W</b> 7.928		<b>+WL8</b> 144	<b>+OL8</b> 696
	6000x1400mm E 2000/1400mm (3)  147kg	<b>T352/M</b> 4.993	<b>T352/C</b> 6.516	<b>T352/W</b> 7.787		<b>+WL8</b> 144	<b>+OL8</b> 696
	6000x1600mm E 2000/1600mm (3)  164kg	<b>T353/M</b> 5.199	<b>T353/C</b> 7.062	<b>T353/W</b> 8.455		<b>+WL8</b> 144	<b>+OL8</b> 696

(\*) COMPACT - HPL TABLE TOP MAXIMUM SIZE FOR ONE PIECE 2400X1800mm. FENIX TABLE TOP MAXIMUM WIDTH 1200mm.  
NOTE: THE MAXIMUM LENGTH PER TABLE TOP IS 2100mm.

DRAWING	MEASURES mm	REF. Euros	REF. Euros	REF. Euros	REF. Euros	REF. Euros	REF. Euros
	<b>(*) Semicircular End Termination Table</b>	Melamine 19mm	Compact - HPL 12mm (*)	Wood 19mm	Black Fenix 20mm (*)	Beech legs supplement	Oak legs supplement
	600x1200mm Fondo 1200mm  19kg	<b>T549/M</b> 957	<b>T549/C</b> 1.057	<b>T549/W</b> 1.237	<b>T549/F</b> 1.249	<b>+WL1</b> 19	<b>+OL1</b> 87
	700x1400mm Fondo 1400mm  19kg	<b>T550/M</b> 991	<b>T550/C</b> 1.149	<b>T550/W</b> 1.361	<b>T550/F</b> 1.509	<b>+WL1</b> 19	<b>+OL1</b> 87
	800x1600mm Fondo 1600mm  23kg	<b>T551/M</b> 1.042	<b>T551/C</b> 1.273	<b>T551/W</b> 1.516	<b>T551/F</b> 1.694	<b>+WL1</b> 19	<b>+OL1</b> 87





NOTE: ONLY ONE TERMINATION PER BENCH.

# Tknika Office Bench-h750



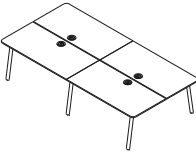

Francesc Rifé

DRAWING	MEASURES mm	REF. Euros	REF. Euros	REF. Euros	REF. Euros	REF. Euros	REF. Euros
	<b>2 Seater + 2 Top Access + Tray</b>	Melamine 19mm	Compact - HPL 12mm (*)	Wood 19mm	Black Fenix 20mm (*)	Beech legs supplement	Oak legs supplement
	1400x1400mm E 1400x700mm (2)  43kg	<b>T500/M</b> 1.751	<b>T500/C</b> 2.103	<b>T500/W</b> 2.563	<b>T500/F</b> 2.849	<b>+WL4</b> 72	<b>+OL4</b> 348
	1600x1600mm E 1600x800mm (2)  52kg	<b>T501/M</b> 1.863	<b>T501/C</b> 2.374	<b>T501/W</b> 2.905	<b>T501/F</b> 3.258	<b>+WL4</b> 72	<b>+OL4</b> 348
	1800x1600mm E 1800x800mm (2)  58kg	<b>T502/M</b> 1.962	<b>T502/C</b> 2.561	<b>T502/W</b> 3.131	<b>T502/F</b> 3.520	<b>+WL4</b> 72	<b>+OL4</b> 348
	2000x1800mm E 2000x900mm (2)  69kg	<b>T503/M</b> 2.066	<b>T503/C</b> 2.855	<b>T503/W</b> 3.510	<b>T503/F</b> 3.974	<b>+WL4</b> 72	<b>+OL4</b> 348

NOTE: DEPTHS AVAILABLE BETWEEN 600 AND 900mm. CONTACT WITH FACTORY FOR PRICE AND AVAILABILITY.  
THE MAXIMUM LENGTH PER TABLE TOP IS 2000mm.  
DOUBLE TRAY MEASURES 420x137x130mm.

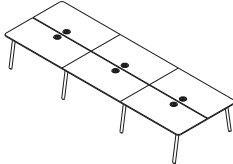
DRAWING	MEASURES mm	REF. Euros	REF. Euros	REF. Euros	REF. Euros	REF. Euros	REF. Euros
	<b>4 Seater + 4 Top Access + 2 Trays</b>	Melamine 19mm	Compact - HPL 12mm (*)	Wood 19mm	Black Fenix 20mm (*)	Beech legs supplement	Oak legs supplement
	2800x1400mm E 1400x700mm (4)  86kg	<b>T510/M</b> 3.280	<b>T510/C</b> 3.985	<b>T510/W</b> 4.905	<b>T510/F</b> 5.460	<b>+WL6</b> 108	<b>+OL6</b> 522
	3200x1600mm E 1600x800mm (4)  105kg	<b>T511/M</b> 3.523	<b>T511/C</b> 4.544	<b>T511/W</b> 5.611	<b>T511/F</b> 6.298	<b>+WL6</b> 108	<b>+OL6</b> 522
	3600x1600mm E 1800x800mm (4)  117kg	<b>T512/M</b> 3.724	<b>T512/C</b> 4.916	<b>T512/W</b> 6.057	<b>T512/F</b> 6.819	<b>+WL6</b> 108	<b>+OL6</b> 522
	4000x1800mm E 2000x900mm (4)  139kg	<b>T513/M</b> 3.929	<b>T513/C</b> 5.509	<b>T513/W</b> 6.813	<b>T513/F</b> 7.722	<b>+WL6</b> 108	<b>+OL6</b> 522

NOTE: DEPTHS AVAILABLE BETWEEN 600 AND 900mm. CONTACT WITH FACTORY FOR PRICE AND AVAILABILITY.  
THE MAXIMUM LENGTH PER TABLE TOP IS 2000mm.  
DOUBLE TRAY MEASURES 420x137x130mm.

DRAWING	MEASURES mm	REF. Euros	REF. Euros	REF. Euros	REF. Euros	REF. Euros	REF. Euros
	<b>6 Seater + 6 Top Access + 3 Trays</b>	Melamine 19mm	Compact - HPL 12mm (*)	Wood 19mm	Black Fenix 20mm (*)	Beech legs supplement	Oak legs supplement
	4200x1400mm E 1400x700mm (6)  120kg	<b>T520/M</b> 4.795	<b>T520/C</b> 5.856	<b>T520/W</b> 7.234	<b>T520/F</b> 8.059	<b>+WL8</b> 144	<b>+OL8</b> 696
	4800x1600mm E 1600x800mm (6)  140kg	<b>T521/M</b> 5.161	<b>T521/C</b> 6.694	<b>T521/W</b> 8.289	<b>T521/F</b> 9.310	<b>+WL8</b> 144	<b>+OL8</b> 696
	5400x1600mm E 1800x800mm (6)  166kg	<b>T522/M</b> 5.458	<b>T522/C</b> 7.249	<b>T522/W</b> 8.960	<b>T522/F</b> 10.090	<b>+WL8</b> 144	<b>+OL8</b> 696
	6000x1800mm E 2000x900mm (6)  181kg	<b>T523/M</b> 5.768	<b>T523/C</b> 8.137	<b>T523/W</b> 10.096	<b>T523/F</b> 11.451	<b>+WL8</b> 144	<b>+OL8</b> 696

NOTE: DEPTHS AVAILABLE BETWEEN 600 AND 900mm. CONTACT WITH FACTORY FOR PRICE AND AVAILABILITY.  
THE MAXIMUM LENGTH PER TABLE TOP IS 2000mm.  
DOUBLE TRAY MEASURES 420x137x130mm.

# Tknika Office Bench-h750











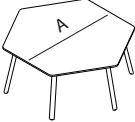



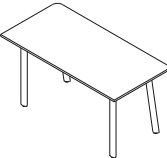

Francesc Rifé

DRAWING	MEASURES mm	REF. Euros	REF. Euros	REF. Euros	REF. Euros	REF. Euros	REF. Euros
	<b>2 Seater + Semicircular End + 2 Top Access + Tray</b> (*)	Melamine 19mm	Compact - HPL 12mm (*)	Wood 19mm	Black Fenix 20mm (*)	Beech legs supplement	Oak legs supplement
	1400x1400mm E 1400x700mm (2)  43kg	<b>T530/M</b> 1.813	<b>T530/C</b> 2.165	<b>T530/W</b> 2.625	<b>T530/F</b> 2.919	<b>+WL4</b> 72	<b>+OL4</b> 348
	1600x1600mm E 1600x800mm (2)  52kg	<b>T531/M</b> 1.938	<b>T531/C</b> 2.451	<b>T531/W</b> 2.983	<b>T531/F</b> 3.342	<b>+WL4</b> 72	<b>+OL4</b> 348
	1800x1600mm E 1800x800mm (2)  58kg	<b>T532/M</b> 2.039	<b>T532/C</b> 2.636	<b>T532/W</b> 3.205	<b>T532/F</b> 3.604	<b>+WL4</b> 72	<b>+OL4</b> 348
	2000x1800mm E 2000x900mm (2)  69kg	<b>T533/M</b> 2.149	<b>T533/C</b> 2.938	<b>T533/W</b> 3.589	<b>T533/F</b> 4.063	<b>+WL4</b> 72	<b>+OL4</b> 348
NOTE: DEPTHS AVAILABLE BETWEEN 600 AND 900mm. CONTACT WITH FACTORY FOR PRICE AND AVAILABILITY. THE MAXIMUM LENGTH PER TABLE TOP IS 2000mm. DOUBLE TRAY MEASURES 420x137x130mm.							
	<b>4 Seater + Semicircular End + 4 Top Access + 2 Trays</b> (*)	Melamine 19mm	Compact - HPL 12mm (*)	Wood 19mm	Black Fenix 20mm (*)	Beech legs supplement	Oak legs supplement
	2800x1400mm E 1400x700mm (4)  86kg	<b>T540/M</b> 2.983	<b>T540/C</b> 3.692	<b>T540/W</b> 4.611	<b>T540/F</b> 5.140	<b>+WL6</b> 108	<b>+OL6</b> 522
	3200x1600mm E 1600x800mm (4)  105kg	<b>T541/M</b> 3.221	<b>T541/C</b> 4.242	<b>T541/W</b> 5.309	<b>T541/F</b> 5.966	<b>+WL6</b> 108	<b>+OL6</b> 522
	3600x1600mm E 1800x800mm (4)  117kg	<b>T542/M</b> 3.421	<b>T542/C</b> 4.613	<b>T542/W</b> 5.755	<b>T542/F</b> 6.488	<b>+WL6</b> 108	<b>+OL6</b> 522
	4000x1800mm E 2000x900mm (4)  139kg	<b>T543/M</b> 3.622	<b>T543/C</b> 5.199	<b>T543/W</b> 6.503	<b>T543/F</b> 7.385	<b>+WL6</b> 108	<b>+OL6</b> 522
NOTE: DEPTHS AVAILABLE BETWEEN 600 AND 900mm. CONTACT WITH FACTORY FOR PRICE AND AVAILABILITY. THE MAXIMUM LENGTH PER TABLE TOP IS 2000mm. DOUBLE TRAY MEASURES 420x137x130mm.							
	<b>6 Seater + Semicircular End + 6 Top Access + 3 Trays</b> (*)	Melamine 19mm	Compact - HPL 12mm (*)	Wood 19mm	Black Fenix 20mm (*)	Beech legs supplement	Oak legs supplement
	4200x1400mm E 1400x700mm (6)  120kg	<b>T560/M</b> 4.501	<b>T560/C</b> 5.559	<b>T560/W</b> 6.939	<b>T560/F</b> 7.735	<b>+WL8</b> 144	<b>+OL8</b> 696
	4800x1600mm E 1600x800mm (6)  148kg	<b>T561/M</b> 4.860	<b>T561/C</b> 6.391	<b>T561/W</b> 7.987	<b>T561/F</b> 8.982	<b>+WL8</b> 144	<b>+OL8</b> 696
	5400x1600mm E 1800x800mm (6)  166kg	<b>T562/M</b> 5.156	<b>T562/C</b> 6.948	<b>T562/W</b> 8.658	<b>T562/F</b> 9.761	<b>+WL8</b> 144	<b>+OL8</b> 696
	6000x1800mm E 2000x900mm (6)  199kg	<b>T563/M</b> 5.460	<b>T563/C</b> 7.829	<b>T563/W</b> 9.786	<b>T563/F</b> 11.112	<b>+WL8</b> 144	<b>+OL8</b> 696
NOTE: DEPTHS AVAILABLE BETWEEN 600 AND 900mm. CONTACT WITH FACTORY FOR PRICE AND AVAILABILITY. THE MAXIMUM LENGTH PER TABLE TOP IS 2000mm. DOUBLE TRAY MEASURES 420x137x130mm.							
	<b>(*) Semicircular End Termination Table</b>	Melamine 19mm	Compact - HPL 12mm (*)	Wood 19mm	Black Fenix 20mm (*)	Beech legs supplement	Oak legs supplement
	600x1200mm Depth 1400mm  15kg	<b>T550/M</b> 991	<b>T550/C</b> 1.149	<b>T550/W</b> 1.361	<b>T550/F</b> 1.509	<b>+WL1</b> 19	<b>+OL1</b> 87
	700x1400mm Depth 1400mm  19kg	<b>T551/M</b> 1.042	<b>T551/C</b> 1.273	<b>T551/W</b> 1.516	<b>T551/F</b> 1.694	<b>+WL1</b> 19	<b>+OL1</b> 87
	800x1600mm Depth 1600mm  23kg	<b>T552/M</b> 1.098	<b>T552/C</b> 1.414	<b>T552/W</b> 1.691	<b>T552/F</b> 1.903	<b>+WL1</b> 19	<b>+OL1</b> 87
NOTE: ONLY ONE TERMINATION PER TABLE.							

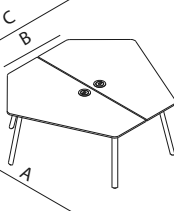

# Tknika Diverse-h750

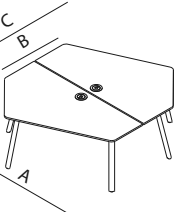





Francesc Rifé

DRAWING	MEASURES mm	REF.	€uros	REF.	€uros	REF.	€uros	REF.	€uros	REF.	€uros	REF.	€uros	
	<b>Hexagonal</b>	Melamine 19mm	Compact - HPL 12mm (*)	Wood 19mm	Black Fenix 20mm (*)	Beech legs supplement	Oak legs supplement							
	A 1400mm DP 616mm	 27kg	<b>T600/M</b>	1.339	<b>T600/C</b>	1.559	<b>T600/W</b>	2.021	<b>T600/F</b>	2.273	<b>+WL6</b>	108	<b>+OL6</b>	522
	A 1600mm DP 731mm	 38kg	<b>T601/M</b>	1.780	<b>T601/C</b>	2.099	<b>T601/W</b>	2.652	<b>T601/F</b>	2.994	<b>+WL6</b>	108	<b>+OL6</b>	522
	A 1800mm DP 847mm	 47kg	<b>T602/M</b>	1.976	<b>T602/C</b>	2.438	<b>T602/W</b>	3.088	<b>T602/F</b>	3.510	<b>+WL6</b>	108	<b>+OL6</b>	522
	<b>Circle with Flat Face to Wall</b>	Melamine 19mm	Compact - HPL 12mm (*)	Wood 19mm	Black Fenix 20mm (*)	Beech legs supplement	Oak legs supplement							
	Ø1200mm DP 577mm	 19kg	<b>T610/M</b>	984	<b>T610/C</b>	1.025	<b>T610/W</b>	1.431	<b>T610/F</b>	1.611	<b>WL4</b>	72	<b>+OL4</b>	348
	Ø1400mm DP 718mm	 29kg	<b>T611/M</b>	1.315	<b>T611/C</b>	1.409	<b>T611/W</b>	1.927			<b>WL4</b>	72	<b>+OL4</b>	348
	Ø1600mm DP 860mm	 30kg	<b>T612/M</b>	1.378	<b>T612/C</b>	1.604	<b>T612/W</b>	2.192			<b>WL4</b>	72	<b>+OL4</b>	348
	NOTE: THE Ø1200 TABLE IS MANUFACTURED WITH DIRECT LEGS (WITHOUT STRUCTURE).													
	<b>Home Office to Wall</b>	Melamine 19mm	Compact - HPL 12mm (*)	Wood 19mm	Black Fenix 20mm (*)	Beech legs supplement	Oak legs supplement							
	1200x600mm DP 928/328mm	 14kg	<b>T620/M</b>	812	<b>T620/C</b>	799	<b>T620/W</b>	1.023	<b>T620/F</b>	1.128	<b>WLR</b>	60	<b>OLR</b>	356
	1400x700mm DP 1128/428mm	 23kg	<b>T621/M</b>	1.021	<b>T621/C</b>	1.045	<b>T621/W</b>	1.305	<b>T621/F</b>	1.451	<b>WLR</b>	60	<b>OLR</b>	356
	1600x800mm DP 1328/528mm	 28kg	<b>T622/M</b>	1.067	<b>T622/C</b>	1.154	<b>T622/W</b>	1.453	<b>T622/F</b>	1.626	<b>WLR</b>	60	<b>OLR</b>	356
	1800x900mm DP 1528/628mm	 34kg	<b>T623/M</b>	1.157	<b>T623/C</b>	1.312	<b>T623/W</b>	1.655	<b>T623/F</b>	1.861	<b>WLR</b>	60	<b>OLR</b>	356
	<b>Bench 2 Seater Hexagonal Symmetrical + 2 Top Access + Tray</b>	Melamine 19mm	Compact - HPL 12mm (*)	Wood 19mm	Black Fenix 20mm (*)	Beech legs supplement	Oak legs supplement							
	A B C 1800x1000x2078mm DPT 1085mm	 68kg	<b>T630/M</b>	2.684	<b>T630/C</b>	2.996	<b>T630/W</b>	3.834	<b>T630/F</b>	4.349	<b>+WL6</b>	108	<b>+OL6</b>	522
	A B C 2000x1200x2336mm DPT 1195mm	 68kg	<b>T631/M</b>	2.796	<b>T631/C</b>	3.303	<b>T631/W</b>	4.256	<b>T631/F</b>	4.857	<b>+WL6</b>	108	<b>+OL6</b>	522
	<b>Bench 2 Seater Hexagonal Asymmetric + 2 Top Access + Tray</b>	Melamine 19mm	Compact - HPL 12mm (*)	Wood 19mm	Black Fenix 20mm (*)	Beech legs supplement	Oak legs supplement							
	A B C 1800x1000x2078mm DPT 1085mm	 68kg	<b>T632/M</b>	2.684	<b>T632/C</b>	2.996	<b>T632/W</b>	3.834	<b>T632/F</b>	4.349	<b>+WL6</b>	108	<b>+OL6</b>	522
	A B C 2000x1200x2336mm DPT 1195mm	 68kg	<b>T633/M</b>	2.796	<b>T633/C</b>	3.303	<b>T633/W</b>	4.256	<b>T633/F</b>	4.857	<b>+WL6</b>	108	<b>+OL6</b>	522

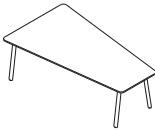
(\*) COMPACT - HPL TABLE TOP MAXIMUM SIZE FOR ONE PIECE 2400X1800mm. FENIX TABLE TOP MAXIMUM WIDTH 1200mm.

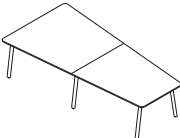

# Tknika Diverse-h750

Francesc Rifé

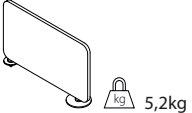
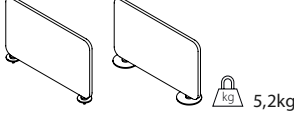
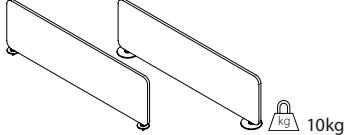

DRAWING	MEASURES mm	REF.	€uros	REF.	€uros	REF.	€uros	REF.	€uros	REF.	€uros	REF.	€uros
	<b>Trapezoidal</b>	Melamine 19mm		Compact - HPL 12mm (*)		Wood 19mm		Black Fenix 20mm (*)		Beech legs supplement		Oak legs supplement	
	2000x1400/800mm DP 1626/1128/528mm  51kg	<b>T070/M</b>	1.673	<b>T070/C</b>	2.066	<b>T070/W</b>	2.647			<b>+WL4</b>	72	<b>+OL4</b>	348
	2400x1400/800mm DP 2027/ 1128/528mm  67kg	<b>T071/M</b>	2.019	<b>T071/C</b>	2.510	<b>T071/W</b>	3.176			<b>+WL4</b>	72	<b>+OL4</b>	348
2800x1600/800mm DP 2426/1328/ 528mm  82kg	<b>T072/M</b>	2.823			<b>T072/W</b>	4.509			<b>+WL4</b>	72	<b>+OL4</b>	348	
	<b>Trapezoidal 2 Table Tops</b>	Melamine 19mm		Compact - HPL 12mm (*)		Wood 19mm		Black Fenix 20mm (*)		Beech legs supplement		Oak legs supplement	
	3200x1600/1000mm DP 2x1380/1328/728mm  91kg	<b>T073/M</b>	2.882	<b>T073/C</b>	3.606	<b>T073/W</b>	4.686			<b>+WL6</b>	108	<b>+OL6</b>	522
	4000x1600/1000mm DP 2x1780/1328/728mm  110kg	<b>T074/M</b>	3.187	<b>T074/C</b>	4.191	<b>T074/W</b>	5.451			<b>+WL6</b>	108	<b>+OL6</b>	522

NOTE: FOR OTHER TRAPEZOIDAL CONFIGURATIONS, CONTACT WITH FACTORY FOR PRICE AND AVAILABILITY.  
(\*) COMPACT - HPL TABLE TOP MAXIMUM SIZE FOR ONE PIECE 2400X1800mm. FENIX TABLE TOP MAXIMUM WIDTH 1200mm.

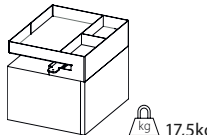
## ACCESSORIES

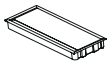
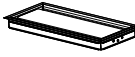
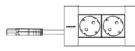
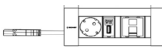
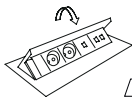

DRAWING	SPECIFICATION	REF.	€uros
	<b>PIVOTING DIVIDER UPHOLSTERED</b> 665x30xH410mm Group D	<b>TK01/D</b>	347
	<b>PANTALLA PIVOTANTE TAPIZADA</b> 665x30xH410mm Group C & COF	<b>TK01/C</b>	362
	<b>PANTALLA PIVOTANTE TAPIZADA</b> 665x30xH410mm Group B & Valencia	<b>TK01/B</b>	379
	<b>PANTALLA PIVOTANTE TAPIZADA</b> 665x30xH410mm Group A & COL	<b>TK01/A</b>	413
	<b>PANTALLA PIVOTANTE TAPIZADA</b> 665x30xH410mm Soft leather	<b>TK01/L</b>	425
ATTENTION AVAILABLE ONLY FOR TKNIKA OFFICE BENCH, TKNIKA DIVERSE BENCH 2 SEATER HEXAGONAL SYMMETRICAL AND ASYMMETRIC. NOTE: SPECIFY THE COLOUR OF THE PAINT FOR THE ROUND METALLIC SUPPORT. IF THERE IS NO SPECIFICATION, IT WILL BE PAINTED BLACK.			
	<b>SINGLE DIVIDER UPHOLSTERED</b> 665x30xH410mm Group D	<b>TK02/D</b>	347
	<b>SINGLE DIVIDER UPHOLSTERED</b> 665x30xH410mm Group C & COF	<b>TK02/C</b>	362
	<b>SINGLE DIVIDER UPHOLSTERED</b> 665x30xH410mm Group B & Valencia	<b>TK02/B</b>	379
	<b>SINGLE DIVIDER UPHOLSTERED</b> 665x30xH410mm Group A & COL	<b>TK02/A</b>	413
	<b>SINGLE DIVIDER UPHOLSTERED</b> 665x30xH410mm Soft leather	<b>TK02/L</b>	425
NOTE: SPECIFY THE COLOUR OF THE PAINT FOR THE ROUND METALLIC SUPPORT. IF THERE IS NO SPECIFICATION, IT WILL BE PAINTED BLACK.			
	<b>DOUBLE DIVIDER UPHOLSTERED</b> 1325x30xH410mm Group D	<b>TK04/D</b>	369
	<b>DOUBLE DIVIDER UPHOLSTERED</b> 1325x30xH410mm Group C & COF	<b>TK04/C</b>	394
	<b>DOUBLE DIVIDER UPHOLSTERED</b> 1325x30xH410mm Group B & Valencia	<b>TK04/B</b>	433
	<b>DOUBLE DIVIDER UPHOLSTERED</b> 1325x30xH410mm Group A & COL	<b>TK04/A</b>	505
	<b>DOUBLE DIVIDER UPHOLSTERED</b> 1325x30xH410mm Soft leather	<b>TK04/L</b>	532
NOTE: SPECIFY THE COLOUR OF THE PAINT FOR THE ROUND METALLIC SUPPORT. IF THERE IS NO SPECIFICATION, IT WILL BE PAINTED BLACK.			
	<b>POWDER COATED METALLIC PENCIL HOLDER</b> 338x158xH73mm Includes interior protective black rubber.	<b>AC074</b>	154
ATTENTION AVAILABLE ONLY FOR TKNIKA OFFICE BENCH, TKNIKA DIVERSE BENCH 2 SEATER HEXAGONAL SYMMETRICAL AND ASYMMETRIC.			
	<b>SUSPENDED PEDESTAL WITH DRAWER</b> 395x353xH355mm Drawer in melamine and pencil holder in metal powder coated. Includes interior protective black rubber. Single colour, four colours available: white, graphite, olive green, rose, grey clay or red clay.	<b>AC075</b>	657

## ELECTRIFICATION

DRAWING	SPECIFICATION	REF.	Euros
	<b>CUT OUT</b> (special dimensions)	<b>AC051</b>	110
	<p><b>CABLE GROMMET IN METAL</b>            Ø140mm support / Ø80mm passage            It will be powder coated in the same colour as the table frame, unless the client indicates another colour from the AKABA paint sample card.</p>	<b>AC072</b>	55
	<p><b>TOP ACCESS SMALL RECTANGULAR IN METAL</b>            240x100mm White or black colours (cut out included)</p>	<b>AC060</b>	76
	<p><b>TOP ACCESS BIG RECTANGULAR IN METAL</b>            320x100mm White or black colours (cut out included)</p>	<b>AC061</b>	83
	<p><b>TOP ACCESS DOUBLE OPENING IN METAL</b>            320x135mm White or black colours (cut out included)</p>	<b>AC062</b>	161
	<p><b>SURFACE ELECTRICAL UNIT (*)</b>            White or black , 2 schukos (cut out include)</p>	<b>AC070</b>	232
	<p><b>SURFACE ELECTRICAL UNIT (*)</b>            White or black, 1 schuko + 1 USB charger A and C + 2 RJ45 + 1 HDMI (cut out include)</p>	<b>AC071</b>	571
	<p><b>SURFACE MOUNTED ELECTRICAL 4 MODULES (*)</b>            45° opening, metal box with folding top and 4 useful modules.            Kit: 2 schukos points + 1 HDMI + RJ45 + cable connection strap 3 meters. (cut out include)</p>	<b>AC056</b>	635

(\*) FOR OTHER ELECTRIFICATION CONFIGURATIONS CONTACT WITH THE FACTORY.

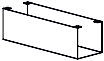
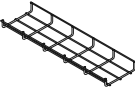
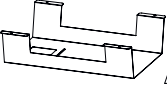
## ELECTRIFICATION

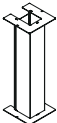
DRAWING	SPECIFICATION	REF.	Euros
	<p><b>METALLIC CABLE TRAY FOR ELECTRIFICATION</b> 420x155xH130mm</p> <p>It will be powder coated in the same colour as the table frame, unless the client indicates another colour from the AKABA paint sample card.</p>	<b>AC054</b>	110
	<p><b>WIRE MESH TRAY</b> 400x150x60mm</p> <p><b>WIRE MESH TRAY</b> 700x150x60mm</p>	<b>AC073</b>	60
		<b>AC076</b>	69
<p>NOTE: IT WILL BE POWDER COATED IN THE SAME COLOUR AS THE TABLE FRAME, UNLESS THE CLIENT INDICATES ANOTHER COLOUR FROM THE AKABA PAINT SAMPLE CARD.</p>			
	<p><b>DOUBLE METALLIC CABLE TRAY FOR ELECTRIFICATION</b> 600x460x154mm</p> <p>It will be powder coated in the same colour as the table frame, unless the client indicates another colour from the AKABA paint sample card.</p>	<b>AC078</b>	88
	<p><b>FLEXIBLE CABLE RISER</b> White or black Table H750</p>	<b>A34/M</b>	92
	<p><b>SQUARE TOTEM FOR CABLE RISE</b> 100x100mm Valid only with REF AC078</p>	<b>A71/M</b>	289

---

# Usoa

Tabuena & Leache Arquitectos



Fusion of a light yet robust table design. Usoa is a meeting table program that meets and exceeds all expectations. It offers the best features of a table: robust worktops of natural materials, solid structure of metal with a clean light design that creates great personality.

One of the main features of the Usoa program is its ability to cover large lengths, creating robust tables up to 5.4 meters long and 1.6 meters wide with only two columns. The multiple combinations of surface, colour, shape and size allow you to create the perfect meeting table for any application.

---

# Usoa

Tabuena & Leache Arquitectos

## TABLE TOPS

---

19mm thick table tops in melamine with ABS edges or MDF board veneered in natural wood with acrylic matt UV protection varnish available in several finishes.

## WOOD TABLE TOPS

---

AKABA S.A. will not be responsible for the total uniformity and similarity in the tables that have more than one table top. The nature of this finish, its diversity of veins, tones and shades from one sheet to another, mean that exact uniformity cannot be guaranteed.

## LEGS

---

Legs with height adjustable glides in folded powder coated steel of 8 mm thickness.

## CABLE MANAGEMENT SYSTEM











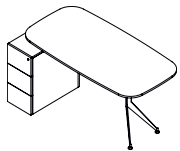



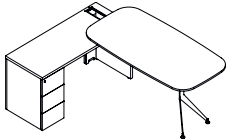



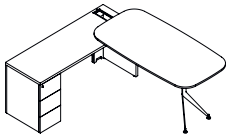

---

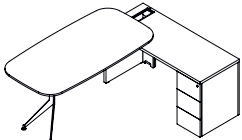
Compass leg 75°: Flexible cable riser in black or white colour and U shaped melamine central beam to allocate cables and electrical outlets. Top access on top in metal powder coated black or white.

Balance leg 90°: Cable riser with open cover placed on the "balance" leg. The central steel structure allows cabling along the beam. Top access on top in metal powder coated black or white.

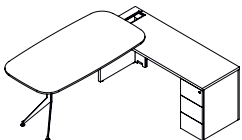
# Usoa Workstation

Tabuena & Leache Arquitectos

DRAWING	SPECIFICATION	MEASURES mm	REF.	€uros	REF.	€uros
	<b>With Pedestal</b> Ambidextrous pedestal. Cable rise through the back of the pedestal (double bottom). Option 3 drawers, or 3 drawers + file. Total height 750mm.	1400x922mm E 1400x800mm	 53kg	Melamine 19mm <b>US65/M</b> 2.135	Wood 19mm (*) <b>US65/W</b> 3.178	
		1600x922mm E 1600x800mm	 57kg	<b>US66/M</b> 2.172	<b>US66/W</b> 3.237	
		1800x922mm E 1800x800mm	 60kg	<b>US67/M</b> 2.216	<b>US67/W</b> 3.301	
		2000x922mm E 2000x800mm	 63kg	<b>US68/M</b> 2.258	<b>US68/W</b> 3.362	
	<b>With Left Add-on Table + Pedestal</b> Add-on table of 1385x565mm. Cable rise through the cable duct. Top access and tray on Add-on table. Option 3 drawers, or 3 drawers + file. Total height 750mm.	1705x1600mm E 1400x800mm	 82kg	Melamine 19mm <b>US69/M</b> 2.832	Wood 19mm (*) <b>US69/W</b> 3.871	
		1905x1600mm E 1600x800mm	 84kg	<b>US70/M</b> 2.869	<b>US70/W</b> 3.935	
		2105x1600mm E 1800x800mm	 86kg	<b>US71/M</b> 2.912	<b>US71/W</b> 3.994	
		2305x1600mm E 2000x800mm	 88kg	<b>US72/M</b> 2.952	<b>US72/W</b> 4.058	
	<b>With Left Add-on Table + Pedestal</b> Add-on table of 1585x565mm. Cable rise through the cable duct. Top access and tray on Add-on table. Option 3 drawers, or 3 drawers + file. Total height 750mm.	1705x1800mm E 1400x800mm	 84kg	Melamine 19mm <b>US73/M</b> 2.995	Wood 19mm (*) <b>US73/W</b> 4.040	
		1905x1800mm E 1600x800mm	 86kg	<b>US74/M</b> 3.037	<b>US74/W</b> 4.098	
		2105x1800mm E 1800x800mm	 88kg	<b>US75/M</b> 3.074	<b>US75/W</b> 4.160	
		2305x1800mm E 2000x800mm	 90kg	<b>US76/M</b> 3.114	<b>US76/W</b> 4.221	
	<b>With Right Add-on Table + Pedestal</b> Add-on table of 1385x565mm. Cable rise through the cable duct. Top access and tray on Add-on table. Option 3 drawers, or 3 drawers + file. Total height 750mm.	1705x1600mm E 1400x800mm	 82kg	Melamine 19mm <b>US77/M</b> 2.832	Wood 19mm (*) <b>US77/W</b> 3.871	
		1905x1600mm E 1600x800mm	 84kg	<b>US78/M</b> 2.869	<b>US78/W</b> 3.935	
		2105x1600mm E 1800x800mm	 86kg	<b>US79/M</b> 2.912	<b>US79/W</b> 3.994	
		2305x1600mm E 2000x800mm	 88kg	<b>US80/M</b> 2.952	<b>US80/W</b> 4.058	
	<b>With Right Add-on Table + Pedestal</b> Add-on table of 1585x565mm. Cable rise through the cable duct. Top access and tray on Add-on table. Option 3 drawers, or 3 drawers + file. Total height 750mm.	1705x1800mm E 1400x800mm	 84kg	Melamine 19mm <b>US81/M</b> 2.995	Wood 19mm (*) <b>US81/W</b> 4.040	
		1905x1800mm E 1600x800mm	 86kg	<b>US82/M</b> 3.037	<b>US82/W</b> 4.098	
		2105x1800mm E 1800x800mm	 88kg	<b>US83/M</b> 3.074	<b>US83/W</b> 4.160	
		2305x1800mm E 2000x800mm	 90kg	<b>US84/M</b> 3.114	<b>US84/W</b> 4.221	

(\*) TABLE TOPS IN WOOD, ADD-ON TABLE AND PEDESTALS IN MELAMINE.



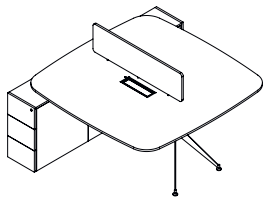

# Usoa Workstation

Tabuena & Leache Arquitectos

DRAWING	SPECIFICATION	MEASURES mm	REF.	€uros	REF.	€uros	
	<p><b>Bench 2 Seater + 2 Pedestals</b></p> <p>Cable rise through the back of the pedestal. Double tray under the table top. Two top access. Divider lacquered included, white or black. Total height 750mm.</p>	1400x1844mm E 1400x1600mm			Melamine 19mm		
			1600x1844mm E 1600x1600mm	US85/M	4.550	US85/W	5.430
			1800x1844mm E 1800x1600mm	US86/M	4.590	US86/W	5.614
			US87/M	4.633	US87/W	5.798	

(\*) TABLE TOPS IN WOOD, ADD-ON TABLE AND PEDESTALS IN MELAMINE.

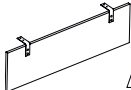
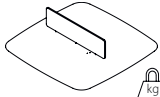
## ACCESSORIES

DRAWING	SPECIFICATION	REF.	€uros
	<b>MODESTY PANEL IN MELAMINE</b> H320mm Table 1400mm	U01/M	206
	<b>MODESTY PANEL IN MELAMINE</b> H320mm Table 1600mm	U02/M	219
	<b>MODESTY PANEL IN MELAMINE</b> H320mm Table 1800mm	U03/M	227
	<b>MODESTY PANEL IN MELAMINE</b> H320mm Table 2000mm	U04/M	237
	<b>PRICE INCREASE UPHOLSTERED DIVIDER</b> Group D	UPT/D	359
	<b>PRICE INCREASE UPHOLSTERED DIVIDER</b> Group C	UPT/C	392
	<b>PRICE INCREASE UPHOLSTERED DIVIDER</b> Group B	UPT/B	481
	<b>PRICE INCREASE UPHOLSTERED DIVIDER</b> Group A	UPT/A	544
	<b>FLEXIBLE CABLE RISER</b> White or black	A34/M	92

# Usoa Compass Leg

Tabuena & Leache Arquitectos

DRAWING

MEASURES mm

REF. Euros

REF. Euros



## Oval

1400x700xH750mm E 1400x700mm	54kg
1600x800xH750mm E 1600x800mm	60kg
1800x900xH750mm E 1800x900mm	67kg
2100x1200xH750mm E 2100x1200mm	85kg

## Oval 2 Table Tops

2400x1200xH750mm E 1200x1200mm (2)	92kg
2700x1200xH750mm E 1350x1200mm (2)	99kg
3000x1200xH750mm E 1500x1200mm (2)	106kg
3300x1200xH750mm E 1650x1200mm (2)	115kg
3600x1200xH750mm E 1800x1200mm (2)	121kg
3900x1400xH750mm E 1950x1400mm (2)	144kg

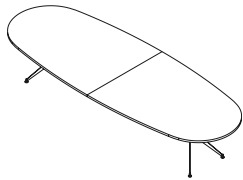

## Barrel

1400x700xH750mm E 1400x700mm	54kg
1600x800xH750mm E 1600x800mm	60kg
1800x900xH750mm E 1800x900mm	67kg
2100x1200xH750mm E 2100x1200mm	85kg



## Barrel 2 Table Tops

2400x1200xH750mm E 1200x1200mm (2)	92kg
2700x1200xH750mm E 1350x1200mm (2)	99kg
3000x1200xH750mm E 1500x1200mm (2)	106kg
3300x1200xH750mm E 1650x1200mm (2)	115kg
3600x1200xH750mm E 1800x1200mm (2)	121kg
3900x1400xH750mm E 1950x1400mm (2)	144kg

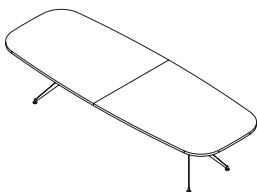

### WITHOUT TOP ACCESS

Melamine 19mm		Wood 19mm (*)	
<b>US64/M</b>	1.131	<b>US64/W</b>	1.591
<b>US41/M</b>	1.233	<b>US41/W</b>	1.827
<b>US42/M</b>	1.286	<b>US42/W</b>	2.033
<b>US01/M</b>	2.082	<b>US01/W</b>	3.609

### WITHOUT TOP ACCESS

Melamine 19mm		Wood 19mm (*)	
<b>US43/M</b>	2.534	<b>US43/W</b>	4.140
<b>US02/M</b>	2.707	<b>US02/W</b>	4.673
<b>US44/M</b>	2.976	<b>US44/W</b>	4.859
<b>US03/M</b>	3.075	<b>US03/W</b>	5.410
<b>US45/M</b>	3.179	<b>US45/W</b>	5.982
<b>US04/M</b>	3.281	<b>US04/W</b>	6.556

### WITHOUT TOP ACCESS

Melamine 19mm		Wood 19mm (*)	
<b>US46/M</b>	1.131	<b>US46/W</b>	1.591
<b>US47/M</b>	1.233	<b>US47/W</b>	1.827
<b>US48/M</b>	1.286	<b>US48/W</b>	2.033
<b>US05/M</b>	2.082	<b>US05/W</b>	3.609

### WITHOUT TOP ACCESS

Melamine 19mm		Wood 19mm (*)	
<b>US49/M</b>	2.534	<b>US49/W</b>	4.140
<b>US06/M</b>	2.707	<b>US06/W</b>	4.673
<b>US50/M</b>	2.976	<b>US50/W</b>	4.859
<b>US07/M</b>	3.075	<b>US07/W</b>	5.410
<b>US51/M</b>	3.179	<b>US51/W</b>	5.982
<b>US08/M</b>	3.281	<b>US08/W</b>	6.556

(\*) WOODEN TABLE TOPS: AKABA S.A. will not be responsible for the total uniformity and similarity in the tables that have more than one table top. The nature of this finish, its diversity of venis, tones and shades from one sheet to another, mean that exact uniformity cannot be guaranteed.

# Usoa Compass Leg

Tabuena & Leache Arquitectos

DRAWING

MEASURES mm

REF. Euros

REF. Euros



## Oval

1400x700xH750mm E 1400x700mm	55kg
1600x800xH750mm E 1600x800mm	61kg
1800x900xH750mm E 1800x900mm	68kg
2100x1200xH750mm E 2100x1200mm	85kg

## Oval 2 Table Tops

2400x1200xH750mm E 1200x1200mm (2)	92kg
2700x1200xH750mm E 1350x1200mm (2)	99kg
3000x1200xH750mm E 1500x1200mm (2)	106kg
3300x1200xH750mm E 1650x1200mm (2)	115kg
3600x1200xH750mm E 1800x1200mm (2)	121kg
3900x1400xH750mm E 1950x1400mm (2)	144kg

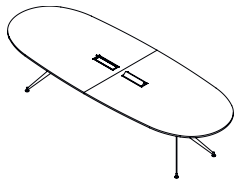

## Barrel

1400x700xH750mm E 1400x700mm	55kg
1600x800xH750mm E 1600x800mm	61kg
1800x900xH750mm E 1800x900mm	68kg
2100x1200xH750mm E 2100x1200mm	85kg



## Barrel 2 Table Tops

2400x1200xH750mm E 1200x1200mm (2)	92kg
2700x1200xH750mm E 1350x1200mm (2)	99kg
3000x1200xH750mm E 1500x1200mm (2)	106kg
3300x1200xH750mm E 1650x1200mm (2)	115kg
3600x1200xH750mm E 1800x1200mm (2)	121kg
3900x1400xH750mm E 1950x1400mm (2)	144kg

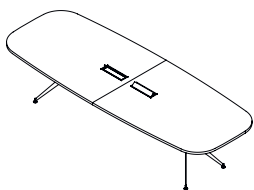

### WITH TOP ACCESS

Melamine 19mm		Wood 19mm (*)	
<b>US52/M</b>	1.449	<b>US52/W</b>	1.909
<b>US53/M</b>	1.551	<b>US53/W</b>	2.143
<b>US54/M</b>	1.601	<b>US54/W</b>	2.348
<b>US11/M</b>	2.275	<b>US11/W</b>	3.802

### WITH 2 TOP ACCESS

Melamine 19mm		Wood 19mm (*)	
<b>US55/M</b>	2.920	<b>US55/W</b>	4.526
<b>US12/M</b>	3.093	<b>US12/W</b>	5.060
<b>US56/M</b>	3.360	<b>US56/W</b>	5.243
<b>US13/M</b>	3.461	<b>US13/W</b>	5.797
<b>US57/M</b>	3.563	<b>US57/W</b>	6.368
<b>US14/M</b>	3.972	<b>US14/W</b>	7.169

### WITH TOP ACCESS

Melamine 19mm		Wood 19mm (*)	
<b>US58/M</b>	1.449	<b>US58/W</b>	1.909
<b>US59/M</b>	1.551	<b>US59/W</b>	2.143
<b>US60/M</b>	1.601	<b>US60/W</b>	2.348
<b>US15/M</b>	2.275	<b>US15/W</b>	3.802

### WITH 2 TOP ACCESS

Melamine 19mm		Wood 19mm (*)	
<b>US61/M</b>	2.920	<b>US61/W</b>	4.526
<b>US16/M</b>	3.093	<b>US16/W</b>	5.060
<b>US62/M</b>	3.360	<b>US62/W</b>	5.243
<b>US17/M</b>	3.461	<b>US17/W</b>	5.797
<b>US63/M</b>	3.563	<b>US63/W</b>	6.368
<b>US18/M</b>	3.972	<b>US18/W</b>	7.169

(\*) WOODEN TABLE TOPS: AKABA S.A. will not be responsible for the total uniformity and similarity in the tables that have more than one table top. The nature of this finish, its diversity of venis, tones and shades from one sheet to another, mean that exact uniformity cannot be guaranteed.

# Usoa Balance Leg

Tabuena & Leache Arquitectos

DRAWING

MEASURES mm

REF. Euros

REF. Euros

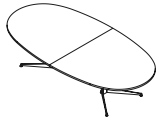

## Oval 2 Table Tops

3200x1600xH750mm  
E 1600x1600mm (2)  174kg

3600x1600xH750mm  
E 1800x1600mm (2)  187kg

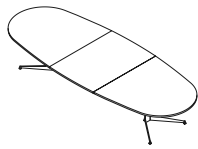

## Oval 3 Table Tops

4200x1600xH750mm  
E 1400x1600mm (3)  206kg

4800x1600xH750mm  
E 1600x1600mm (3)  225kg

5400x1600xH750mm  
E 1800x1600mm (3)  245kg

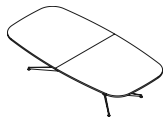

## Barrel 2 Table Tops

3200x1600xH750mm  
E 1600x1600mm (2)  174kg

3600x1600xH750mm  
E 1800x1600mm (2)  187kg

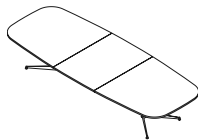

## Barrel 3 Table Tops

4200x1600xH750mm  
E 1400x1600mm (3)  206kg

4800x1600xH750mm  
E 1600x1600mm (3)  225kg

5400x1600xH750mm  
E 1800x1600mm (3)  245kg

### WITHOUT TOP ACCESS

Melamine 19mm		Wood 19mm (*)	
<b>US21/M</b>	3.995	<b>US21/W</b>	6.968
<b>US22/M</b>	4.099	<b>US22/W</b>	7.374

### WITHOUT TOP ACCESS

Melamine 19mm		Wood 19mm (*)	
<b>US23/M</b>	5.151	<b>US23/W</b>	9.123
<b>US24/M</b>	5.644	<b>US24/W</b>	10.129
<b>US25/M</b>	6.010	<b>US25/W</b>	11.074

### WITHOUT TOP ACCESS

Melamine 19mm		Wood 19mm (*)	
<b>US26/M</b>	3.995	<b>US26/W</b>	6.968
<b>US27/M</b>	4.099	<b>US27/W</b>	7.374

### WITHOUT TOP ACCESS

Melamine 19mm		Wood 19mm (*)	
<b>US28/M</b>	5.151	<b>US28/W</b>	9.123
<b>US29/M</b>	5.644	<b>US29/W</b>	10.129
<b>US30/M</b>	6.010	<b>US30/W</b>	11.074

(\*) WOODEN TABLE TOPS: AKABA S.A. will not be responsible for the total uniformity and similarity in the tables that have more than one table top. The nature of this finish, its diversity of venis, tones and shades from one sheet to another, mean that exact uniformity cannot be guaranteed.

# Usoa Balance Leg

Tabuena & Leache Arquitectos

DRAWING

MEASURES mm

REF. Euros

REF. Euros

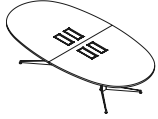

## Oval 2 Table Tops

3200x1600xH750mm  
E 1600x1600mm (2)  176kg

3600x1600xH750mm  
E 1800x1600mm (2)  189kg

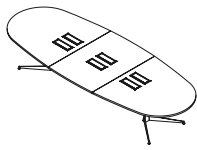

## Oval 3 Table Tops

4200x1600xH750mm  
E 1400x1600mm (3)  210kg

4800x1600xH750mm  
E 1600x1600mm (3)  229kg

5400x1600xH750mm  
E 1800x1600mm (3)  249kg

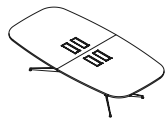

## Barrel 2 Table Tops

3200x1600xH750mm  
E 1600x1600mm (2)  176kg

3600x1600xH750mm  
E 1800x1600mm (2)  189kg

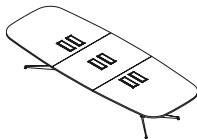

## Barrel 3 Table Tops

4200x1600xH750mm  
E 1400x1600mm (3)  210kg

4800x1600xH750mm  
E 1600x1600mm (3)  229kg

5400x1600xH750mm  
E 1800x1600mm (3)  249kg

### WITH 4 TOP ACCESS

Melamine 19mm		Wood 19mm (*)	
<b>US31/M</b>	4.587	<b>US31/W</b>	7.580
<b>US32/M</b>	4.922	<b>US32/W</b>	8.297

### WITH 6 TOP ACCESS

Melamine 19mm		Wood 19mm (*)	
<b>US33/M</b>	6.305	<b>US33/W</b>	10.302
<b>US34/M</b>	6.716	<b>US34/W</b>	11.265
<b>US35/M</b>	7.138	<b>US35/W</b>	12.296

### WITH 4 TOP ACCESS

Melamine 19mm		Wood 19mm (*)	
<b>US36/M</b>	4.587	<b>US36/W</b>	7.580
<b>US37/M</b>	4.922	<b>US37/W</b>	8.297

### WITH 6 TOP ACCESS

Melamine 19mm		Wood 19mm (*)	
<b>US38/M</b>	6.305	<b>US38/W</b>	10.302
<b>US39/M</b>	6.716	<b>US39/W</b>	11.265
<b>US40/M</b>	7.138	<b>US40/W</b>	12.296

(\*) WOODEN TABLE TOPS: AKABA S.A. will not be responsible for the total uniformity and similarity in the tables that have more than one table top. The nature of this finish, its diversity of venis, tones and shades from one sheet to another, mean that exact uniformity cannot be guaranteed.

---

# Aski



This collection of Aski tables has a timeless appeal that makes it suitable for use in a wide range of domestic, public, educational or corporate settings thanks to its simplicity, durable construction and practical design.

The tables come in a range of sizes with a center column with three different height options, as well as two additional support bases that can be either round or square.

## TABLE TOPS

Top 19mm melamine, 12mm compact - HPL, 20mm fenix, 20mm bevelled plywood laminated or 19mm wood veneer.

## STRUCTURES

Base square or round in S-275 grade steel in several dimensions depending on the top size. Bevelled edges and smoothed surfaces to ensure the optimal adhesion to the paint. Variable widths of sheet from 5mm to 16mm. Powder coated finish. Base prepared for electrification exit. Robust polyamide screwed glides. Good slip, high durability and floor protection.

Column cylindric steel tube from Ø60mm to Ø100mm, 2mm thick. S-275 grade available in several heights. High precision laser tube cutting. Powder coated finish.

## ELECTRIFICATION SYSTEM

Two types of electrifications available: Electrification with 2USB or electrification with 1 electrical outlet + 1 USB A and C.

## TYPES OF EDGES PER TABLE TOP



Melamine, wood and black Fenix:  
Straight edges

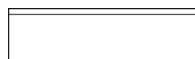

Compact - HPL:  
Straight edges, black body



Plywood laminated:  
Bevelled edges

## CLIENT TABLETOPS' CUT OUT

· 370mm and 490mm bases.

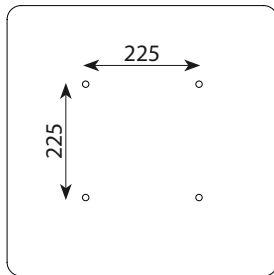

· 615mm bases.

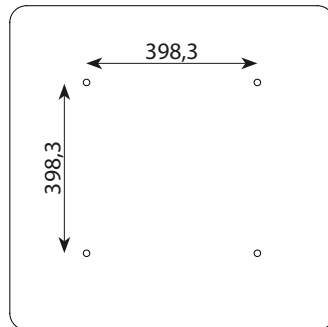



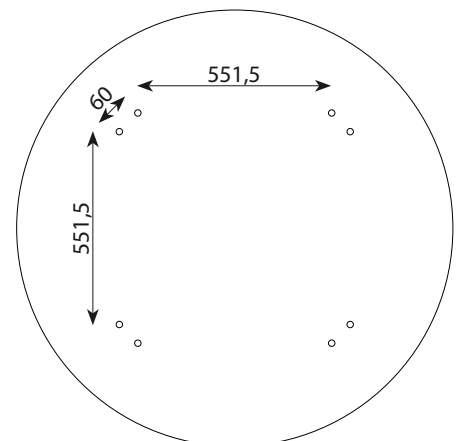
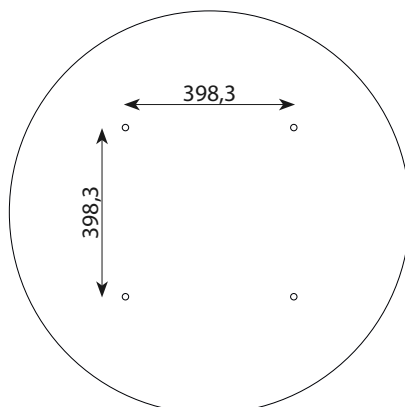
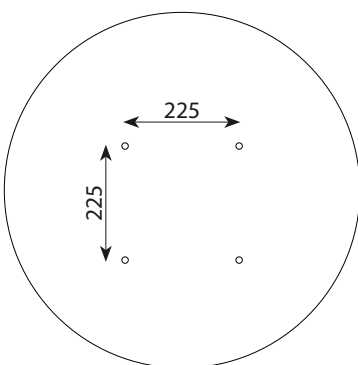
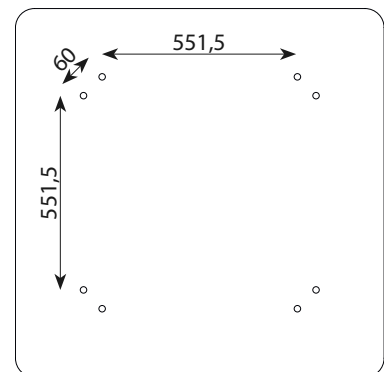







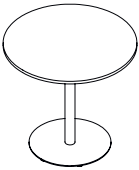









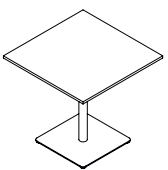

· 745mm bases.



Distance between holes' centres.

NOTE: THE BASE SIZE IS INDICATED IN THE COMMERCIAL REFERENCES.

# Aski-h750











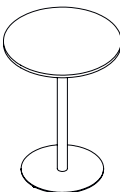







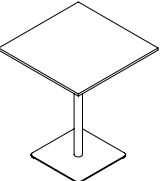

DRAWING	MEASURES mm	REF.	€uros	REF.	€uros	REF.	€uros	REF.	€uros	REF.	€uros	
	<b>Round</b>	Melamine 19mm		Compact - HPL 12mm		Wood 19mm		Plywood laminated 20mm		Black Fenix 20mm		
	Ø500mm B 370 / C 60mm	 14kg	<b>AS01/M</b>	360	<b>AS01/C</b>	390	<b>AS01/W</b>	420	<b>AS01/E</b>	417	<b>AS01/F</b>	447
	Ø600mm B 370 / C 60mm	 15kg	<b>AS02/M</b>	367	<b>AS02/C</b>	422	<b>AS02/W</b>	452	<b>AS02/E</b>	461	<b>AS02/F</b>	491
	Ø700mm B 370 / C 60mm	 16kg	<b>AS03/M</b>	378	<b>AS03/C</b>	461	<b>AS03/W</b>	491	<b>AS03/E</b>	513	<b>AS03/F</b>	548
	Ø800mm B 490 / C 60mm	 21kg	<b>AS04/M</b>	424	<b>AS04/C</b>	536	<b>AS04/W</b>	559	<b>AS04/E</b>	600	<b>AS04/F</b>	658
	Ø900mm B 490 / C 60mm	 23kg	<b>AS05/M</b>	438	<b>AS05/C</b>	587	<b>AS05/W</b>	610	<b>AS05/E</b>	669	<b>AS05/F</b>	729
	Ø1000mm B 490 / C 60mm	 48kg	<b>AS06/M</b>	518	<b>AS06/C</b>	717	<b>AS06/W</b>	736	<b>AS06/E</b>	823	<b>AS06/F</b>	850
	Ø1100mm B 615 / C 100mm	 50kg	<b>AS07/M</b>	704	<b>AS07/C</b>	953	<b>AS07/W</b>	965	<b>AS07/E</b>	1.077	<b>AS07/F</b>	1.104
	Ø1200mm B 615 / C 100mm	 52kg	<b>AS08/M</b>	756	<b>AS08/C</b>	1.077	<b>AS08/W</b>	1.084	<b>AS08/E</b>	1.235	<b>AS08/F</b>	1.260
	Ø1300mm B 615 / C 100mm	 55kg	<b>AS09/M</b>	811	<b>AS09/C</b>	1.189	<b>AS09/W</b>	1.196			<b>AS09/F</b>	1.404
	Ø1400mm B 745 / C 100mm	 62kg	<b>AS10/M</b>	868	<b>AS10/C</b>	1.313	<b>AS10/W</b>	1.313			<b>AS10/F</b>	1.551
	Ø1500mm B 745 / C 100mm	 65kg	<b>AS11/M</b>	894	<b>AS11/C</b>	1.411	<b>AS11/W</b>	1.402			<b>AS11/F</b>	1.679
Ø1600mm B 745 / C 100mm	 68kg	<b>AS12/M</b>	914	<b>AS12/C</b>	1.510	<b>AS12/W</b>	1.491			<b>AS12/F</b>	1.807	
	<b>Square</b>	Melamine 19mm		Compact - HPL 12mm		Wood 19mm		Plywood laminated 20mm		Black Fenix 20mm		
	500x500mm B 370 / C 60mm	 16kg	<b>AS40/M</b>	346	<b>AS40/C</b>	390	<b>AS40/W</b>	406	<b>AS40/E</b>	417	<b>AS40/F</b>	433
	600x600mm B 370 / C 60mm	 17kg	<b>AS41/M</b>	351	<b>AS41/C</b>	422	<b>AS41/W</b>	438	<b>AS41/E</b>	461	<b>AS41/F</b>	479
	700x700mm B 490 / C 60mm	 27kg	<b>AS42/M</b>	399	<b>AS42/C</b>	493	<b>AS42/W</b>	507	<b>AS42/E</b>	543	<b>AS42/F</b>	598
	800x800mm B 490 / C 60mm	 29kg	<b>AS43/M</b>	406	<b>AS43/C</b>	536	<b>AS43/W</b>	546	<b>AS43/E</b>	600	<b>AS43/F</b>	639
	900x900mm B 490 / C 60mm	 32kg	<b>AS44/M</b>	470	<b>AS44/C</b>	646	<b>AS44/W</b>	662	<b>AS44/E</b>	740	<b>AS44/F</b>	717
	1000x1000mm B 615 / C 100mm	 56kg	<b>AS45/M</b>	637	<b>AS45/C</b>	843	<b>AS45/W</b>	848	<b>AS45/E</b>	944	<b>AS45/F</b>	1.001
	1100x1100mm B 615 / C 100mm	 59kg	<b>AS46/M</b>	658	<b>AS46/C</b>	910	<b>AS46/W</b>	912	<b>AS46/E</b>	1.031	<b>AS46/F</b>	1.255
	1200x1200mm B 615 / C 100mm	 62kg	<b>AS47/M</b>	740	<b>AS47/C</b>	1.077	<b>AS47/W</b>	1.072	<b>AS47/E</b>	1.235	<b>AS47/F</b>	1.246
	1300x1300mm B 745 / C 100mm	 84kg	<b>AS48/M</b>	832	<b>AS48/C</b>	1.223	<b>AS48/W</b>	1.221			<b>AS48/F</b>	1.425
1400x1400mm B 745 / C 100mm	 87kg	<b>AS49/M</b>	852	<b>AS49/C</b>	1.313	<b>AS49/W</b>	1.301			<b>AS49/F</b>	1.539	

## ACCESSORIES

DRAWING	SPECIFICATION	REF.	€uros
	<b>PRICE INCREASE ROUNDED EDGES</b> (supplement per table)	<b>AC084</b>	23













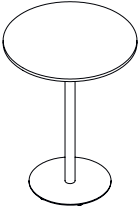







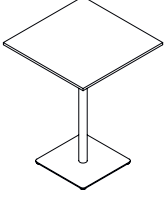

# Aski-h950

DRAWING	MEASURES mm	REF.	€uros	REF.	€uros	REF.	€uros	REF.	€uros	REF.	€uros	
	<b>Round</b>	Melamine 19mm		Compact - HPL 12mm		Wood 19mm		Plywood laminated 20mm		Black Fenix 20mm		
	Ø500mm B 370 / C 60mm	 14kg	<b>AS13/M</b>	367	<b>AS13/C</b>	394	<b>AS13/W</b>	426	<b>AS13/E</b>	424	<b>AS13/F</b>	454
	Ø600mm B 490 / C 60mm	 18kg	<b>AS14/M</b>	442	<b>AS14/C</b>	497	<b>AS14/W</b>	525	<b>AS14/E</b>	536	<b>AS14/F</b>	566
	Ø700mm B 490 / C 60mm	 19kg	<b>AS15/M</b>	454	<b>AS15/C</b>	536	<b>AS15/W</b>	566	<b>AS15/E</b>	589	<b>AS15/F</b>	623
	Ø800mm B 490 / C 60mm	 21kg	<b>AS16/M</b>	465	<b>AS16/C</b>	575	<b>AS16/W</b>	607	<b>AS16/E</b>	651	<b>AS16/F</b>	683
	Ø900mm B 490 / C 60mm	 47kg	<b>AS17/M</b>	486	<b>AS17/C</b>	635	<b>AS17/W</b>	658	<b>AS17/E</b>	717	<b>AS17/F</b>	786
	Ø1000mm B 615 / C 100mm	 49kg	<b>AS18/M</b>	697	<b>AS18/C</b>	894	<b>AS18/W</b>	914	<b>AS18/E</b>	999	<b>AS18/F</b>	1.029
	Ø1100mm B 615 / C 100mm	 51kg	<b>AS19/M</b>	717	<b>AS19/C</b>	965	<b>AS19/W</b>	978	<b>AS19/E</b>	1.091	<b>AS19/F</b>	1.118
	Ø1200mm B 615 / C 100mm	 53kg	<b>AS20/M</b>	772	<b>AS20/C</b>	1.091	<b>AS20/W</b>	1.100	<b>AS20/E</b>	1.251	<b>AS20/F</b>	1.276
	Ø1300mm B 745 / C 100mm	 65kg	<b>AS21/M</b>	1.324	<b>AS21/C</b>	1.700	<b>AS21/W</b>	1.707			<b>AS21/F</b>	1.913
	Ø1400mm B 745 / C 100mm	 67kg	<b>AS22/M</b>	1.342	<b>AS22/C</b>	1.787	<b>AS22/W</b>	1.787			<b>AS22/F</b>	2.027
		<b>Square</b>	Melamine 19mm		Compact - HPL 12mm		Wood 19mm		Plywood laminated 20mm		Black Fenix 20mm	
		500x500mm B 370 / C 60mm	 16kg	<b>AS50/M</b>	351	<b>AS50/C</b>	394	<b>AS50/W</b>	413	<b>AS50/E</b>	424	<b>AS50/F</b>
600x600mm B 370 / C 60mm		 17kg	<b>AS51/M</b>	358	<b>AS51/C</b>	429	<b>AS51/W</b>	442	<b>AS51/E</b>	468	<b>AS51/F</b>	484
700x700mm B 490 / C 60mm		 27kg	<b>AS52/M</b>	404	<b>AS52/C</b>	500	<b>AS52/W</b>	511	<b>AS52/E</b>	548	<b>AS52/F</b>	605
800x800mm B 490 / C 60mm		 29kg	<b>AS53/M</b>	413	<b>AS53/C</b>	541	<b>AS53/W</b>	550	<b>AS53/E</b>	605	<b>AS53/F</b>	646
900x900mm B 615 / C 100mm		 55kg	<b>AS54/M</b>	704	<b>AS54/C</b>	880	<b>AS54/W</b>	894	<b>AS54/E</b>	971	<b>AS54/F</b>	935
1000x1000mm B 615 / C 100mm		 57kg	<b>AS55/M</b>	720	<b>AS55/C</b>	951	<b>AS55/W</b>	958	<b>AS55/E</b>	1.063	<b>AS55/F</b>	1.045
1100x1100mm B 615 / C 100mm		 60kg	<b>AS56/M</b>	736	<b>AS56/C</b>	1.020	<b>AS56/W</b>	1.022	<b>AS56/E</b>	1.157	<b>AS56/F</b>	1.152
1200x1200mm B 615 / C 100mm		 63kg	<b>AS57/M</b>	754	<b>AS57/C</b>	1.091	<b>AS57/W</b>	1.086	<b>AS57/E</b>	1.251	<b>AS57/F</b>	1.260
1300x1300mm B 745 / C 100mm		 78kg	<b>AS58/M</b>	1.306	<b>AS58/C</b>	1.700	<b>AS58/W</b>	1.695			<b>AS58/F</b>	1.901

## ACCESSORIES

DRAWING	SPECIFICATION	REF.	€uros
	<b>PRICE INCREASE ROUNDED EDGES</b> (supplement per table)	<b>AC084</b>	23





# Aski-h1050

DRAWING	MEASURES mm	REF.	€uros	REF.	€uros	REF.	€uros	REF.	€uros	REF.	€uros	
	<b>Round</b>	Melamine 19mm	Compact - HPL 12mm	Wood 19mm	Plywood laminated 20mm	Black Fenix 20mm						
	Ø500mm B 370 / C 60mm	 14kg	<b>AS23/M</b>	367	<b>AS23/C</b>	394	<b>AS23/W</b>	426	<b>AS23/E</b>	424	<b>AS23/F</b>	454
	Ø600mm B 490 / C 60mm	 18kg	<b>AS24/M</b>	442	<b>AS24/C</b>	497	<b>AS24/W</b>	525	<b>AS24/E</b>	536	<b>AS24/F</b>	566
	Ø700mm B 490 / C 60mm	 20kg	<b>AS25/M</b>	454	<b>AS25/C</b>	536	<b>AS25/W</b>	566	<b>AS25/E</b>	589	<b>AS25/F</b>	623
	Ø800mm B 490 / C 60mm	 21kg	<b>AS26/M</b>	465	<b>AS26/C</b>	541	<b>AS26/W</b>	607	<b>AS26/E</b>	605	<b>AS26/F</b>	665
	Ø900mm B 490 / C 60mm	 47kg	<b>AS27/M</b>	484	<b>AS27/C</b>	630	<b>AS27/W</b>	655	<b>AS27/E</b>	715	<b>AS27/F</b>	784
	Ø1000mm B 615 / C 100mm	 49kg	<b>AS28/M</b>	697	<b>AS28/C</b>	894	<b>AS28/W</b>	914	<b>AS28/E</b>	999	<b>AS28/F</b>	1.029
	Ø1100mm B 615 / C 100mm	 51kg	<b>AS29/M</b>	717	<b>AS29/C</b>	965	<b>AS29/W</b>	978	<b>AS29/E</b>	1.091	<b>AS29/F</b>	1.118
	Ø1200mm B 615 / C 100mm	 54kg	<b>AS30/M</b>	772	<b>AS30/C</b>	1.091	<b>AS30/W</b>	1.100	<b>AS30/E</b>	1.251	<b>AS30/F</b>	1.276
	Ø1300mm B 745 / C 100mm	 65kg	<b>AS31/M</b>	1.324	<b>AS31/C</b>	1.700	<b>AS31/W</b>	1.707			<b>AS31/F</b>	1.913
	Ø1400mm B 745 / C 100mm	 68kg	<b>AS32/M</b>	1.342	<b>AS32/C</b>	1.787	<b>AS32/W</b>	1.787			<b>AS32/F</b>	2.027
		<b>Square</b>	Melamine 19mm	Compact - HPL 12mm	Wood 19mm	Plywood laminated 20mm	Black Fenix 20mm					
		500x500mm B 370 / C 60mm	 16kg	<b>AS59/M</b>	351	<b>AS59/C</b>	394	<b>AS59/W</b>	413	<b>AS59/E</b>	424	<b>AS59/F</b>
600x600mm B 370 / C 60mm		 17kg	<b>AS60/M</b>	358	<b>AS60/C</b>	429	<b>AS60/W</b>	442	<b>AS60/E</b>	468	<b>AS60/F</b>	484
700x700mm B 490 / C 60mm		 28kg	<b>AS61/M</b>	404	<b>AS61/C</b>	500	<b>AS61/W</b>	511	<b>AS61/E</b>	548	<b>AS61/F</b>	605
800x800mm B 490 / C 60mm		 30kg	<b>AS62/M</b>	413	<b>AS62/C</b>	541	<b>AS62/W</b>	550	<b>AS62/E</b>	605	<b>AS62/F</b>	646
900x900mm B 615 / C 100mm		 55kg	<b>AS63/M</b>	704	<b>AS63/C</b>	880	<b>AS63/W</b>	894	<b>AS63/E</b>	971	<b>AS63/F</b>	935
1000x1000mm B 615 / C 100mm		 58kg	<b>AS64/M</b>	720	<b>AS64/C</b>	951	<b>AS64/W</b>	958	<b>AS64/E</b>	1.063	<b>AS64/F</b>	1.045
1100x1100mm B 615 / C 100mm		 61kg	<b>AS65/M</b>	736	<b>AS65/C</b>	1.020	<b>AS65/W</b>	1.020	<b>AS65/E</b>	1.157	<b>AS65/F</b>	1.152
1200x1200mm B 615 / C 100mm		 64kg	<b>AS66/M</b>	754	<b>AS66/C</b>	1.091	<b>AS66/W</b>	1.086	<b>AS66/E</b>	1.251	<b>AS66/F</b>	1.260
1300x1300mm B 745 / C 100mm		 67kg	<b>AS67/M</b>	1.306	<b>AS67/C</b>	1.700	<b>AS67/W</b>	1.695			<b>AS67/F</b>	1.901

## ACCESSORIES

DRAWING	SPECIFICATION	REF.	€uros
	<b>PRICE INCREASE ROUNDED EDGES</b> (supplement per table)	<b>AC084</b>	23

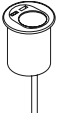
## ACCESSORIES

DRAWING	SPECIFICATION	REF.	€uros
  0,2kg	<b>USB CHARGER</b> Ø37mm grey colour	<b>AC057</b>	138
  0,11kg	<b>USB CHARGER</b> Ø70mm black colour 1 schuko + 1 USB charge A and C  <small>NOTE: VALID FOR TABLES WITH COLUMNS OF Ø100mm (c100)</small>	<b>AC083</b>	296
	<b>HANGER</b> 2 per column	<b>AC058</b>	21

## EXAMPLE OF AN INTEGRATED ELECTRIFICATION SYSTEM

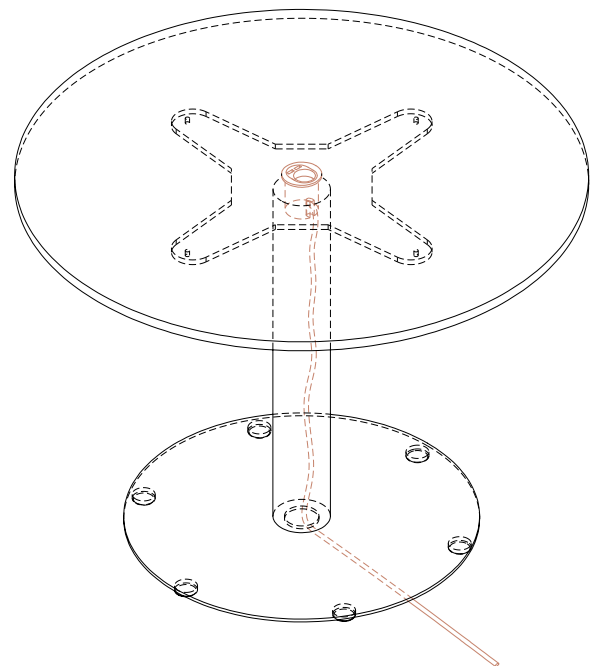
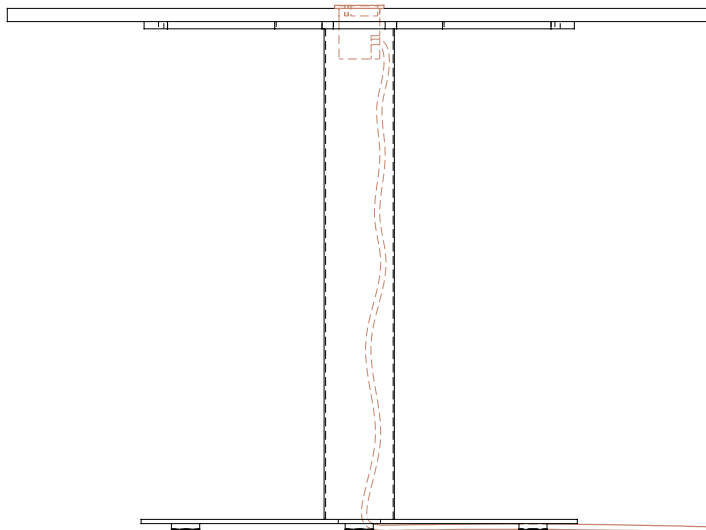

---

# Carma & Carma Folding

Pensi Design Studio



Adaptable to all kinds of spaces, thanks to its wide range of shapes and dimensions, Carma is a modular desk system that creates meeting areas in both conference rooms and coffee corners.

The tops, in customizable material and thickness, are supported by steel columns and a four-star aluminium base. The base has the resistance and lightness of injected aluminium, making these desks tremendously hardwearing and easy to transport. Available in different heights, and in a wide range of compositions.

Carma Folding is a table designed to meet the needs of contract projects, meetings, conference and training rooms. With a folding top thanks to an easily operated mechanism, Carma Folding enables the space required to work to appear and disappear fast and simply. The fact that it can be stacked also means that it takes up very little room.

Its hardwearing and lightweight aluminium base stands on braked castors and connects to the top by means of a tubular steel column. The top (in customizable material and thickness) gives the whole the appearance of being solid, and that's something it definitely is!

# Carma

Pensi Design Studio

Table program made out of bases in polished, powder coated injected aluminium with 2 options of plastic glides, big or small, or metallic glides powder coated or chromed. Column made out of Ø60mm steel in three height with 4 arms cross in injected aluminium, powder coated or chromed.

## TABLE TOPS

Table tops in compact - HPL 12mm, melamine 19mm or wood 19mm.

## WOOD TABLE TOPS

AKABA S.A. will not be responsible for the total uniformity and similarity in the tables that have more than one table top. The nature of this finish, its diversity of veins, tones and shades from one sheet to another, mean that exact uniformity cannot be guaranteed.

## SHORT LEG/LONG LEG

Short leg with glides

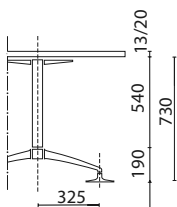

Short leg with castors

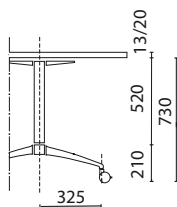

Short leg with contract glides

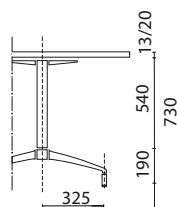

Join bar (measure between axis)

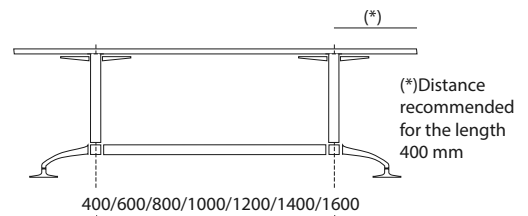

Long leg with glides

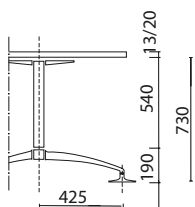

Long leg with castors

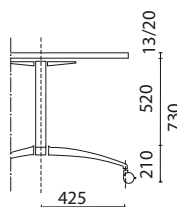

Long leg with contract glides

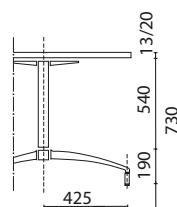

Join bar (measure between axis)

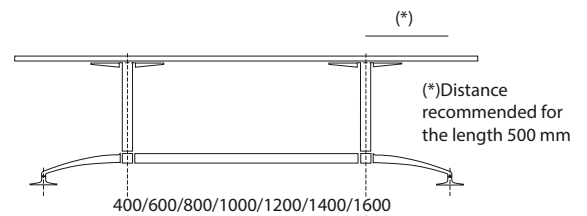

Plastic glides

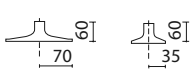

Contract glides



Castors

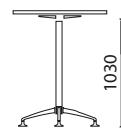

Heights without table top





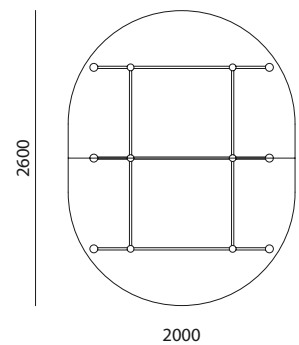
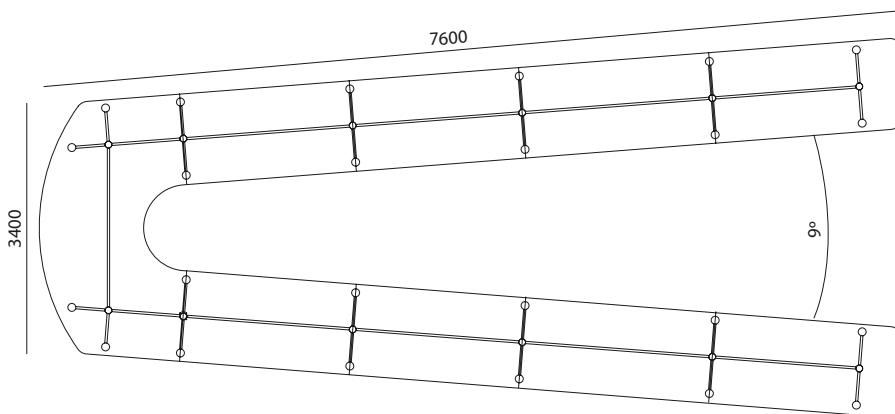
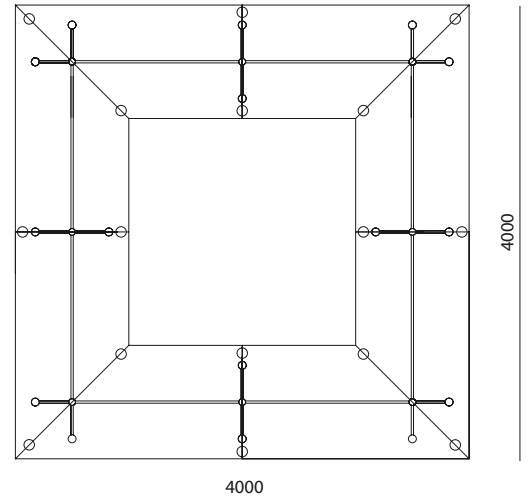
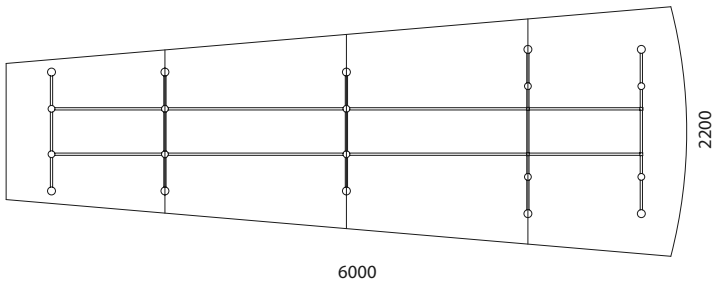
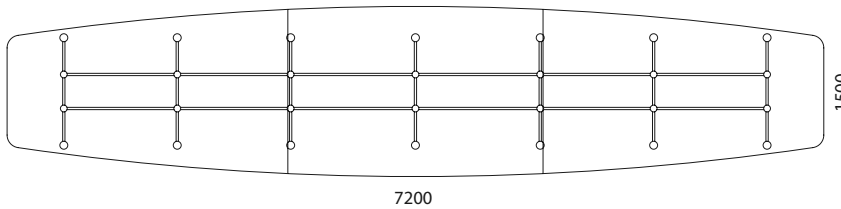
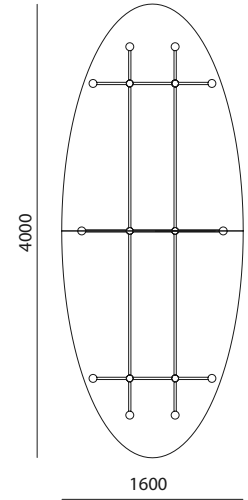
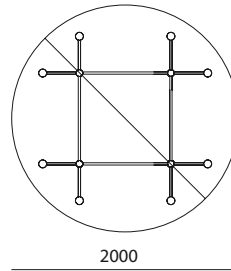
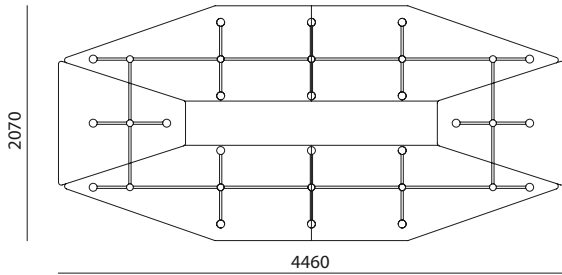







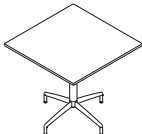

## SPECIAL CONFIGURATIONS

Contact the factory for special configurations.

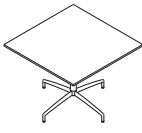

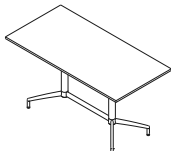
# Carma

Pensi Design Studio

DRAWING	MEASURES mm	REF.	€uros	REF.	€uros	REF.	€uros	€uros	€uros	
	<u>Round</u>	<b>SHORT LEG</b>								
	Ø700xH750mm  9kg	Melamine 19mm or only structure	Compact - HPL 12mm	Wood 19mm (*)	Price increase polish / chromed	Price increase height change				
	Ø800xH750mm  11kg	<b>C31/P</b>	465	<b>C31/H</b>	484	<b>C31/M</b>	500	92	19	
Ø900xH750mm  13kg	<b>C01/P</b>	660	<b>C01/H</b>	722	<b>C01/M</b>	800	92	19		
		<b>C02/P</b>	765	<b>C02/H</b>	857	<b>C02/M</b>	974	92	19	
	<u>Round</u>	<b>LONG LEG</b>								
	Ø1000xH750mm  15kg	Melamine 19mm or only structure	Compact - HPL 12mm	Wood 19mm (*)	Price increase polish / chromed	Price increase height change				
	Ø1100xH750mm  17kg	<b>K01/P</b>	562	<b>K01/H</b>	900	<b>K01/M</b>	1.113	108	19	
		<b>K02/P</b>	580	<b>K02/H</b>	990	<b>K02/M</b>	1.187	108	19	
	<u>Square</u>	<b>SHORT LEG</b>								
	800x800xH750mm  11kg	Melamine 19mm or only structure	Compact - HPL 12mm	Wood 19mm (*)	Price increase polish / chromed	Price increase height change				
		<b>C03/P</b>	484	<b>C03/H</b>	722	<b>C03/M</b>	857	92	19	
	<u>Square</u>	<b>LONG LEG</b>								
	900x900xH750mm  13kg	Melamine 19mm or only structure	Compact - HPL 12mm	Wood 19mm (*)	Price increase polish / chromed	Price increase height change				
	1000x1000xH750mm  15kg	<b>K04/P</b>	548	<b>K04/H</b>	813	<b>K04/M</b>	965	108	19	
		<b>K13/P</b>	562	<b>K13/H</b>	900	<b>K13/M</b>	1.113	108	19	
	<u>Leg 90°</u>	<b>SHORT LEG</b>								
	1200x700xH750mm  18kg	Melamine 19mm or only structure	Compact - HPL 12mm	Wood 19mm (*)	Price increase polish / chromed	Price increase height change				
	1400x700xH750mm  19kg	<b>C04/P</b>	768	<b>C04/H</b>	1.063	<b>C04/M</b>	1.242	156	38	
1600x700xH750mm  21kg	<b>C05/P</b>	791	<b>C05/H</b>	1.127	<b>C05/M</b>	1.333	163	38		
		<b>C06/P</b>	800	<b>C06/H</b>	1.178	<b>C06/M</b>	1.416	170	38	

NOTE: SPECIFY THE TYPE OF GLIDES AND THEIR SIZE. IF NOT SPECIFIED, METAL GLIDES WILL BE SENT.

(\*) WOODEN TABLE TOPS: AKABA S.A. will not be responsible for the total uniformity and similarity in the tables that have more than one table top. The nature of this finish, its diversity of venis, tones and shades from one sheet to another, mean that exact uniformity cannot be guaranteed.

# Carma

Pensi Design Studio

DRAWING	MEASURES mm	REF.	€uros	REF.	€uros	REF.	€uros	€uros	€uros
<b>SHORT LEG</b>									
	<u>Leg 180°</u>	Melamine 19mm or only structure	Compact - HPL 12mm	Wood 19mm (*)	Price increase polish / chromed	Price increase height change			
	1600x800xH750mm	<b>C07/P</b>	813	<b>C07/H</b>	1.237	<b>C07/M</b>	1.510	170	38
	1800x900xH750mm	<b>C08/P</b>	866	<b>C08/H</b>	1.388	<b>C08/M</b>	1.734	175	38
	2000x900xH750mm	<b>C09/P</b>	882	<b>C09/H</b>	1.464	<b>C09/M</b>	1.849	188	38
<b>LONG LEG</b>									
	<u>Leg 180°</u>	Melamine 19mm or only structure	Compact - HPL 12mm	Wood 19mm (*)	Price increase polish / chromed	Price increase height change			
	2000x1000xH750mm	<b>K06/P</b>	976	<b>K06/H</b>	1.620	<b>K06/M</b>	2.048	191	38
	2200x1100xH750mm	<b>K07/P</b>	1.042			<b>K07/M</b>	2.329	202	38
<b>SHORT LEG</b>									
	<u>Leg 180° 2 Table Tops</u>	Melamine 19mm or only structure	Compact - HPL 12mm	Wood 19mm (*)	Price increase polish / chromed	Price increase height change			
	2400x900xH750mm E 1200x900mm (2)	<b>C10/P</b>	1.214	<b>C10/H</b>	2.000	<b>C10/M</b>	2.462	252	57
<b>LONG LEG</b>									
	<u>Leg 180° 2 Table Tops</u>	Melamine 19mm or only structure	Compact - HPL 12mm	Wood 19mm (*)	Price increase polish / chromed	Price increase height change			
	2400x1100xH750mm E 1200x1100mm (2)	<b>K08/P</b>	1.512	<b>K08/H</b>	2.368	<b>K08/M</b>	2.934	282	57
	2800x1100xH750mm E 1400x1100mm (2)	<b>K09/P</b>	1.533	<b>K09/H</b>	2.552	<b>K09/M</b>	3.273	289	57
<b>SHORT LEG</b>									
	<u>Double Structure 2 Table Tops</u>	Melamine 19mm or only structure	Compact - HPL 12mm	Wood 19mm (*)	Price increase polish / chromed	Price increase height change			
	2800x1200xH750mm E 1400x1200mm (2)	<b>C15/P</b>	2.490	<b>C15/H</b>	3.348	<b>C15/M</b>	4.068	454	114
	3200x1200xH750mm E 1600x1200mm (2)	<b>C16/P</b>	2.561	<b>C16/H</b>	3.552	<b>C16/M</b>	4.374	509	114
	3600x1200xH750mm E 1800x1200mm (2)	<b>C17/P</b>	2.652	<b>C17/H</b>	3.777	<b>C10/M</b>	4.702	548	114
	4000x1200xH750mm E 2000x1200mm (2)	<b>C18/P</b>	2.721	<b>C18/H</b>	3.978	<b>C18/M</b>	5.006	564	114

NOTE: SPECIFY THE TYPE OF GLIDES AND THEIR SIZE. IF NOT SPECIFIED, METAL GLIDES WILL BE SENT.

(\*) WOODEN TABLE TOPS: AKABA S.A. will not be responsible for the total uniformity and similarity in the tables that have more than one table top. The nature of this finish, its diversity of venis, tones and shades from one sheet to another, mean that exact uniformity cannot be guaranteed.



# Carma

Pensi Design Studio

DRAWING

MEASURES mm

REF. Euros

REF. Euros

REF. Euros

Euros

Euros

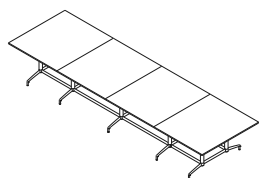

## Double Structure 4 Table Tops

4800x1400xH750mm  
E 1200x1400mm (4)  103kg

5400x1400xH750mm  
E 1400x1400mm (2)  
1300x1400mm (2)  110kg

### SHORT LEG

	Melamine 19mm or only structure	Compact - HPL 12mm	Wood 19mm (*)	Price increase polish / chromed	Price increase height change
<b>C19/P</b>	4.635	<b>C19/H</b> 6.261	<b>C19/M</b> 6.990	871	190
<b>C20/P</b>	4.945	<b>C20/H</b> 6.607	<b>C20/M</b> 7.903	958	190

### SHORT LEG

	Melamine 19mm or only structure	Compact - HPL 12mm	Wood 19mm (*)	Price increase polish / chromed	Price increase height change
<b>C21/P</b>	1.542	<b>C21/H</b> 2.467	<b>C21/M</b> 2.526	454	76
<b>C22/P</b>	1.583	<b>C22/H</b> 2.506	<b>C22/M</b> 2.735	509	76
<b>C23/P</b>	1.700	<b>C23/H</b> 2.625	<b>C23/M</b> 3.028	548	76
<b>C24/P</b>	1.812	<b>C24/H</b> 2.730	<b>C24/M</b> 3.312	564	76

NOTE: SPECIFY THE TYPE OF GLIDES AND THEIR SIZE. IF NOT SPECIFIED, METAL GLIDES WILL BE SENT.

(\*) WOODEN TABLE TOPS: AKABA S.A. will not be responsible for the total uniformity and similarity in the tables that have more than one table top. The nature of this finish, its diversity of venis, tones and shades from one sheet to another, mean that exact uniformity cannot be guaranteed.

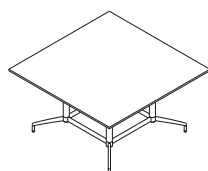

## Angle Leg

1200x1200xH750mm  36kg

1400x1400xH750mm  44kg

1600x1600xH750mm  53kg

1800x1800xH750mm  63kg

## ACCESSORIES

DRAWING

SPECIFICATION

REF.

Euros

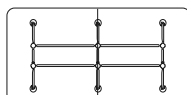

**PRICE INCREASE ROUNDED EDGES**  
(supplement per table)

**AC059**

124



**PRICE INCREASE CASTORS** (supplement per unit)

**AC050**

17

# Carma Barrel

Pensi Design Studio

DRAWING	MEASURES mm	REF.	€uros	REF.	€uros	REF.	€uros	€uros	€uros
	<b>Leg 180°</b>	Melamine 19mm or only structure		Compact - HPL 12mm		Wood 19mm (*)		Price increase polish / chromed	Price increase height change
	1600x900xH750mm  23kg	<b>C30/P</b>	916	<b>C30/H</b>	1.370	<b>C30/M</b>	1.642	154	38
	2000x1000xH750mm  29kg	<b>C32/P</b>	1.091	<b>C32/H</b>	1.629	<b>C32/M</b>	2.057	168	38
	2200x1000xH750mm  31kg	<b>C33/P</b>	1.148			<b>C33/M</b>	2.231	181	38
	<b>Double Structure</b>	Melamine 19mm or only structure		Compact - HPL 12mm		Wood 19mm (*)		Price increase polish / chromed	Price increase height change
	2200x1200xH750mm  23kg	<b>C34/P</b>	1.874			<b>C34/M</b>	3.257	339	76
	<b>Double Structure 2 Table Tops</b>	Melamine 19mm or only structure		Compact - HPL 12mm		Wood 19mm (*)		Price increase polish / chromed	Price increase height change
	2800x1200xH750mm  60kg E 1400x1200mm (2)	<b>C35/P</b>	2.639	<b>C35/H</b>	3.303	<b>C35/M</b>	4.052	438	114
	3600x1400xH750mm  75kg E 1800x1400mm (2)	<b>C36/P</b>	2.934	<b>C36/H</b>	3.859	<b>C36/M</b>	4.782	534	114
	<b>Double Structure 3 Table Tops</b>	Melamine 19mm or only structure		Compact - HPL 12mm		Wood 19mm (*)		Price increase polish / chromed	Price increase height change
	4200x1600xH750mm  99kg E 1400x1600mm (3)	<b>C37/P</b>	4.219	<b>C37/H</b>	5.643	<b>C37/M</b>	6.793	726	152
	<b>Double Structure 4 Table Tops</b>	Melamine 19mm or only structure		Compact - HPL 12mm		Wood 19mm (*)		Price increase polish / chromed	Price increase height change
	5600x1600xH750mm  130kg E 1400x1600mm (4)	<b>C38/P</b>	5.180	<b>C38/H</b>	7.099	<b>C38/M</b>	8.652	736	190

NOTE: SPECIFY THE TYPE OF GLIDES AND THEIR SIZE. IF NOT SPECIFIED, METAL GLIDES WILL BE SENT.







(\*) WOODEN TABLE TOPS: AKABA S.A. will not be responsible for the total uniformity and similarity in the tables that have more than one table top. The nature of this finish, its diversity of venis, tones and shades from one sheet to another, mean that exact uniformity cannot be guaranteed.

## ACCESSORIES

DRAWING	SPECIFICATION	REF.	€uros
	PRICE INCREASE CASTORS (supplement per unit)	<b>AC050</b>	17

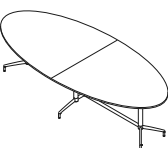
# Carma Oval

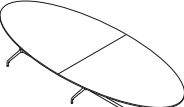
Pensi Design Studio

DRAWING	MEASURES mm	REF.	€uros	REF.	€uros	REF.	€uros	€uros	€uros	
	<b>Leg 180°</b>		Melamine 19mm or only structure	Compact - HPL 12mm	Wood 19mm (*)	Price increase polish / chromed	Price increase height change			
	1800x1100xH750mm	 30kg	<b>C39/P</b>	1.093	<b>C39/H</b>	1.491	<b>C39/M</b>	1.910	209	38
	2200x1100xH750mm	 35kg	<b>C40P</b>	1.127	<b>C40/H</b>	1.633	<b>C40/M</b>	2.121	232	38
	<b>Leg 90° 2 Table Tops</b>		Melamine 19mm or only structure	Compact - HPL 12mm	Wood 19mm (*)	Price increase polish / chromed	Price increase height change			
	3000x1300xH750mm E 1500x1300mm (2)	 54kg	<b>C29/P</b>	2.517	<b>C29/H</b>	3.387	<b>C29/M</b>	4.015	305	76
	3600x1300xH750mm E 1800x1500mm (2)	 73kg	<b>C41P</b>	2.657	<b>C41/H</b>	3.614	<b>C41/M</b>	4.400	330	76
	<b>Double Structure 2 Table Tops</b>		Melamine 19mm or only structure	Compact - HPL 12mm	Wood 19mm (*)	Price increase polish / chromed	Price increase height change			
	4000x1600xH750mm E 800x1300mm (2)	 87kg	<b>C42/P</b>	3.005	<b>C42/H</b>	4.260	<b>C42/M</b>	5.409	557	114

NOTE: SPECIFY THE TYPE OF GLIDES AND THEIR SIZE. IF NOT SPECIFIED, METAL GLIDES WILL BE SENT.





(\*) WOODEN TABLE TOPS: AKABA S.A. will not be responsible for the total uniformity and similarity in the tables that have more than one table top. The nature of this finish, its diversity of venis, tones and shades from one sheet to another, mean that exact uniformity cannot be guaranteed.

## ACCESSORIES

DRAWING	SPECIFICATION	REF.	€uros
	<b>PRICE INCREASE CASTORS</b> (suplement per unit)	<b>AC050</b>	17

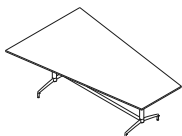
# Carma Trapezoidal

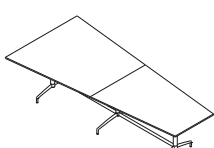

Pensi Design Studio

DRAWING	MEASURES mm	REF.	€uros	REF.	€uros	REF.	€uros	€uros	€uros
	<b>Trapezoid</b>	Melamine 19mm or only structure		Compact - HPL 12mm		Wood 19mm (*)		Price increase polish / chromed	Price increase height change
	2000x1500x800xH750mm  36kg	<b>C25/P</b>	1.544	<b>C25/H</b>	2.492	<b>C25/M</b>	3.136	209	57
	2400x1500x800xH750mm  41kg	<b>C26/P</b>	1.686			<b>C26/M</b>	3.584	232	57
	<b>Trapezoid 2 Table Tops</b>	Melamine 19mm or only structure		Compact - HPL 12mm		Wood 19mm (*)		Price increase polish / chromed	Price increase height change
	2800x1500x800xH750mm E 1400x750mm (2)  48kg	<b>C27/P</b>	2.309	<b>C27/H</b>	3.360	<b>C27/M</b>	4.260	284	76
	3200x1500x800xH750mm E 1600x750mm (2)  53kg	<b>C28/P</b>	2.394	<b>C28/H</b>	3.603	<b>C28/M</b>	4.633	314	76





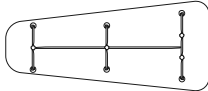

NOTE: SPECIFY THE TYPE OF GLIDES AND THEIR SIZE. IF NOT SPECIFIED, METAL GLIDES WILL BE SENT.

(\*) WOODEN TABLE TOPS: AKABA S.A. will not be responsible for the total uniformity and similarity in the tables that have more than one table top. The nature of this finish, its diversity of venis, tones and shades from one sheet to another, mean that exact uniformity cannot be guaranteed.

## ACCESSORIES

DRAWING	SPECIFICATION	REF.	€uros
	<b>PRICE INCREASE ROUNDED EDGES</b> (supplement per table)	<b>AC059</b>	124
	<b>PRICE INCREASE CASTORS</b> (supplement per unit)	<b>AC050</b>	17

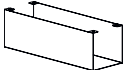
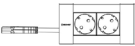
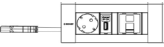
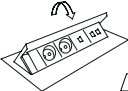
## ELECTRIFICATION

DRAWING	SPECIFICATION	REF.	Euros
	<b>COT OUT TABLE TOP</b> (customer measures)	<b>AC051</b>	110
	<b>CABLE GROMMET Ø80mm</b> white, black or grey (cut out include)	<b>AC052</b>	39
	<b>TOP ACCESS SMALL IN METAL</b> 240x100mm White or black (cut out include)	<b>AC060</b>	76
	<b>TOP ACCESS LARG IN METAL</b> 320x100mm White or black (cut out include)	<b>AC061</b>	83
	<b>TOP ACCESS DOUBLE OPENING IN METAL</b> 320x135mm White or black (cut out include)	<b>AC062</b>	161
	<b>CABLE GROMMET IN METAL</b> 100x100mm White or black (cut out include)	<b>AC063</b>	67
	<b>INTERNAL CABLE TRAY</b> 420x155xH130mm	<b>AC054</b>	110
	<b>SURFACE ELECTRICAL UNIT (*)</b> White or black , 2 schukos (cut out include)	<b>AC070</b>	232
	<b>SURFACE ELECTRICAL UNIT (*)</b> White or black, 1 schuko + 1 USB charger A and C + 2 RJ45 + 1 HDMI (cut out include)	<b>AC071</b>	571
	<b>SURFACE MOUNTED ELECTRICAL 4 MODULES</b> 45° opening, metal box with folding top and 4 useful modules. Kit: 2 schukos points + 1 HDMI + RJ45 + cable connection strap 3 meters. (cut out include)	<b>AC056</b>	635
	<b>FLEXIBLE CABLE RISER</b> White or black	<b>A34/M</b>	92

(\*) FOR OTHER ELECTRIFICATION CONFIGURATIONS CONTACT WITH THE FACTORY.

# Carma Folding

Pensi Design Studio

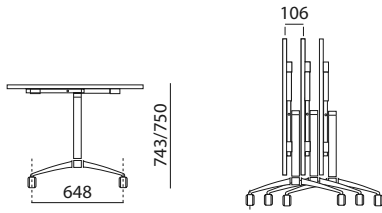

Folding table composed of frame made of injected aluminium powder coated or polished with price increase and with blanking castors.

Column made of Ø60mm steel tube and table tops in 13mm thickness compact - HPL or 20mm thickness melamine or wood.

DRAWING	MEASURES mm	REF.	€uros	REF.	€uros	REF.	€uros	€uros
	<b>Without Length</b>	Melamine 19mm	Compact - HPL 12mm	Wood 19mm	Price increase polish / chromed			
	1200x700mm Structure 1000mm  22,5kg	<b>914/M</b>	1.075	<b>914/C</b>	1.267	<b>914/W</b>	1.443	147
	1400x700mm Structure 1200mm  24,0kg	<b>915/M</b>	1.129	<b>915/C</b>	1.409	<b>915/W</b>	1.617	147
	1600x800mm Structure 1400mm  27,0kg	<b>916/M</b>	1.182	<b>916/C</b>	1.553	<b>916/W</b>	1.826	147
	<b>With Length</b>	Melamine 19mm	Compact - HPL 12mm	Wood 19mm	Price increase polish / chromed			
	1800x700mm Structure 1200mm  28,0kg	<b>917/M</b>	1.152	<b>917/C</b>	1.519	<b>917/W</b>	1.794	147
	2000x800mm Structure 1200mm  30,0kg	<b>918/M</b>	1.189	<b>918/C</b>	1.656	<b>918/W</b>	2.000	147
	2200x900mm Structure 1400mm  34,0kg	<b>919/M</b>	1.249	<b>919/W</b>	2.215		147	

ATTENTION THE MAXIMUM WIDTH OF THE TABLE IS 1100MM, CHECK PRICES WITH THE FACTORY.  
NOTE: BARREL/OVAL SHAPED WORKTOPS ARE AVAILABLE, CONTACT WITH THE FACTORY.



## ACCESSORIES

DRAWING	SPECIFICATION	REF.	€uros	REF.	€uros	REF.	€uros
		Melamine 19mm	Compact - HPL 12mm	Wood 19mm			
	<b>MODESTY PANEL 1200x300mm</b> Table 1200mm	<b>893/M</b>	124	<b>893/C</b>	268	<b>893/W</b>	360
	<b>MODESTY PANEL 1400x300mm</b> Table 1400mm	<b>894/M</b>	131	<b>894/C</b>	294	<b>894/W</b>	383
	<b>MODESTY PANEL 1600x300mm</b> Table 1600mm	<b>895/M</b>	138	<b>895/C</b>	317	<b>895/W</b>	424
	<b>MODESTY PANEL 1800x300mm</b> Table 1800mm	<b>896/M</b>	147	<b>896/C</b>	344	<b>896/W</b>	461
	<b>MODESTY PANEL 2000x300mm</b> Table 2000mm	<b>897/M</b>	154	<b>897/C</b>	374	<b>897/W</b>	500
	<b>MODESTY PANEL 2200x300mm</b> Table 2200mm	<b>898/M</b>	161	<b>898/W</b>		546	
	<b>LINKING DEVICE BETWEEN TABLES</b> (set of 4 units per table)	<b>799/A</b>	52				

# Carma Folding

Pensi Design Studio

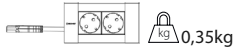
## ELECTRIFICATION

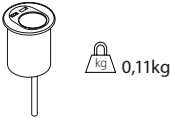
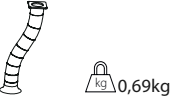
DRAWING	SPECIFICATION	REF.	€uros
	<b>COT OUT TABLE TOP</b> (customer measures)	<b>AC051</b>	110
	<b>SURFACE ELECTRICAL UNIT (*)</b> White or black, 2 schukos (cut out include)	<b>AC070</b>	232
	<b>SURFACE ELECTRICAL UNIT (*)</b> White or black, 1 schuko + 1 USB charger A and C + 2 RJ45 + 1 HDMI (cut out include)	<b>AC071</b>	571
	<b>USB CHARGER</b> Ø37mm grey colour	<b>AC057</b>	138
	<b>USB CHARGER</b> Ø70mm black colour 1 schuko + 1 USB charge A and C	<b>AC083</b>	296
	<b>FLEXIBLE CABLE RISER</b> White or black	<b>A34/M</b>	92

(\*) OTHER ELECTRIFICATION CONFIGURATIONS AVAILABLE. PLEASE CONTACT THE FACTORY.

## POSITION IN CARMA FOLDING

Choose the position of the electrification from the following options:

· Option A

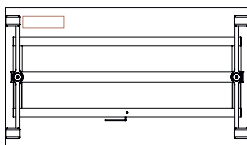

· Option B

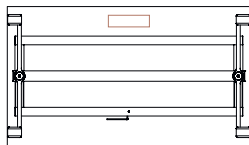

· Option C

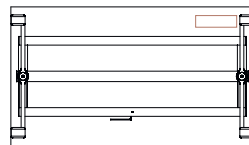

· Option D

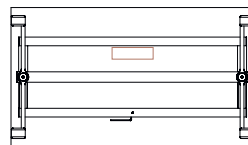

---

# Bat Office

Francesc Rifé



In Basque, “bat” is the beginning, the first number. Design, style and functionality are... one. They're Bat. But Bat also reflects the concept of “unity”. Because at Akaba we unite to work, to design, create and dream.

Taking that idea as our basis, we develop this desk which unites balanced design with style and impressive functionality. Everything has a reason to be and flows in the same direction. Each of us have our space, but united we create a space for everyone.



---

# Bat Office

Francesc Rifé

## TABLE TOPS

---

Table tops made of 30mm thick melamine with ABS edges with integrated electrical / data boxes with top access. Steel frame under structure in powder coated finish.

## OPEN END LEG/SOLID LEG

---

Open end 2mm (3/32") thick steel leg measuring 70x20mm (2 3/4" x 3/4") powder coated with leveling glides. Melamine solid leg T-shape made of 30mm (1 1/4") thick melamine with ABS edges with leveling glides. Optional shelves.

## BUCKS/DRAWER

---

Bucks with casters in melamine, 20mm (3/4") thick. Front of drawers in melamine with steel drawer runners and stop control system. Exchangeable looks with optional master key. Options: 1 drawer, 3 drawers, 1 drawer + file drawer.

## SUPPORT CABINETS FOR EXECUTIVE WORKSTATIONS

---

Frame, tops, doors and shelves made of 20mm (3/4") melamine with leveling glides. Front of drawers in melamine with handles and steel drawer runners. Exchangeable locks with optional master key.

## SUPPORT CABINETS FOR SPINE COMPOSITIONS

---

Frame, tops, doors and shelves made of 20mm (3/4") melamine with leveling glides. Storage cabinet options: open, open with Gromet, 3 drawers, with doors, low configuration with upholstered padded cushion.

## ELECTRIFICATION SYSTEM

---

Composed of metal top access with front opening.

Workstation: made of a cable duct for raising cables and a metal tray to allocated the electrification kit

Spine compositions: made of cable riser duct through cabinet and metallic tray to allocated the electrification kit.

Executive workstation: cable rise through support cabinet by cable duct and metal tray for allocated the of electrification kit.

Bench composition: cable riser through a solid metal column and large capacity trays for allocated the electrification kits and cables.

Meeting tables: cable rise through a solid metal column and metal trays to allocated the electrification kit and cables.

## ACCESSORIES

---

Multiple possibilities for accessories: melamine or upholstered screen dividers (optional LEED lighting), great variety of metal trays, file metal trays, mobile storage, CPU containers, flexible cable risers.

## DIVIDERS

---

Melamine of 19mm or upholstered for bench.

# Bat Office

Francesc Rifé

## WORKSTATIONS

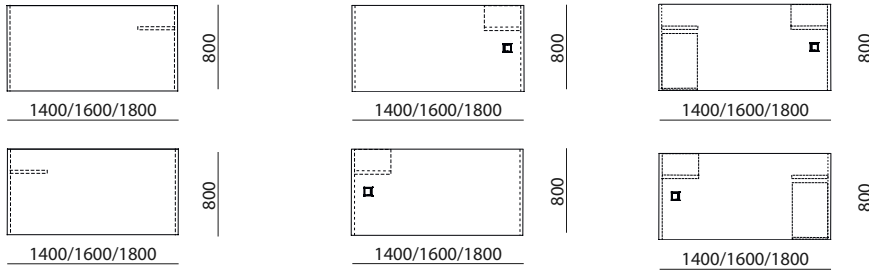

## WORKSTATIONS WITH ADD-ON TABLE

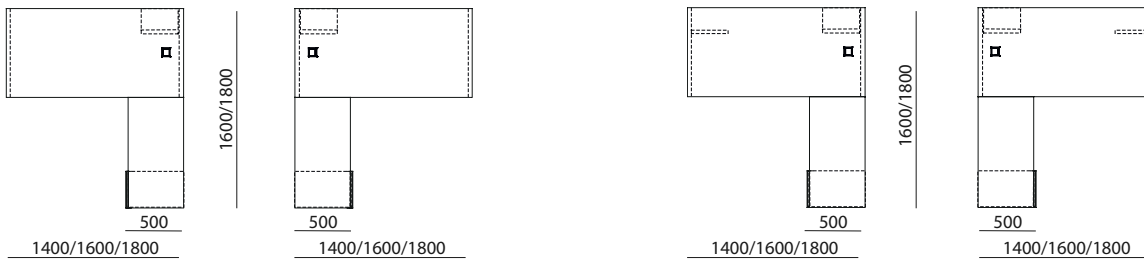

## SPINE

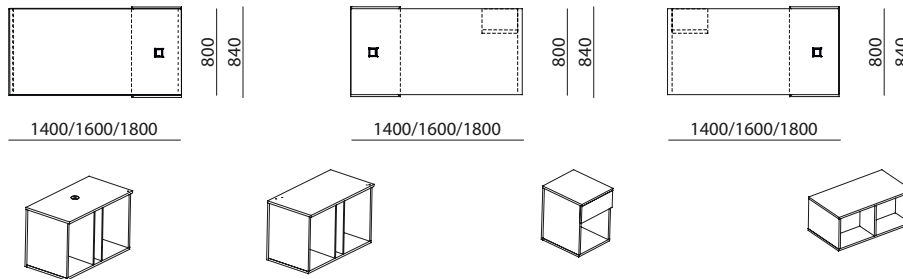

## RECEPTION

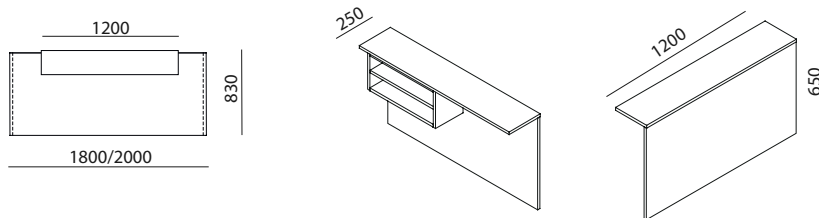

## EXECUTIVE

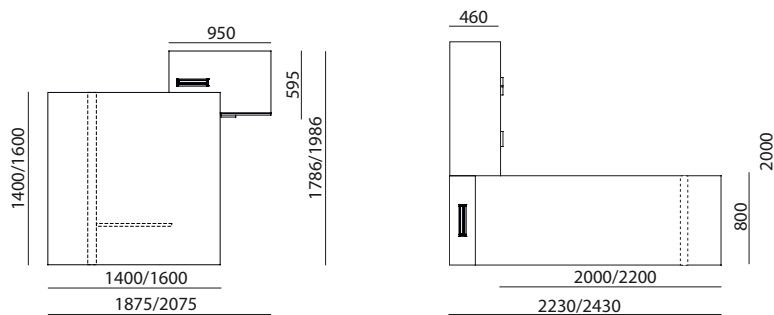

# Bat Office

Francesc Rifé

## BENCH

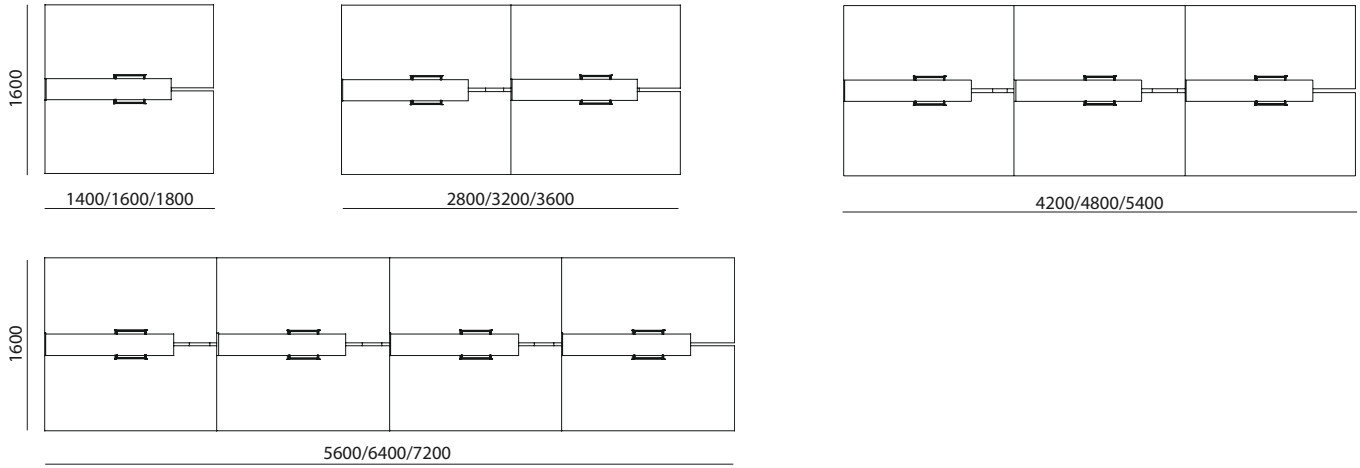

## MEETING

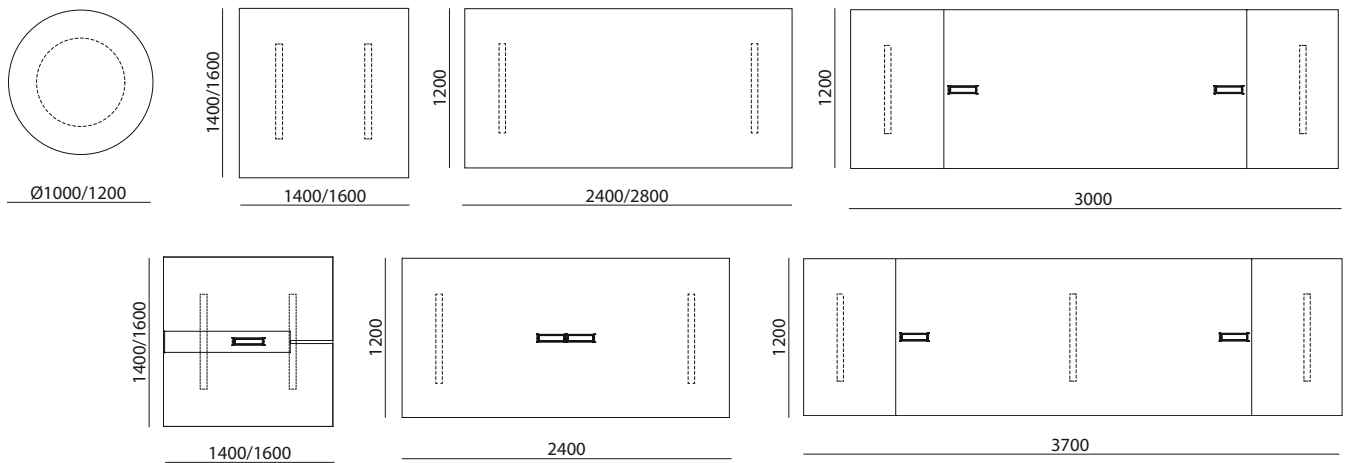

## ACCESSORIES

Flexible cable riser



Totem

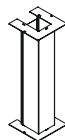

Drawers

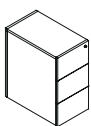

Pedestal modules for bench

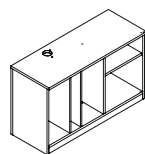

Melamine modesty panel

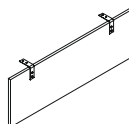



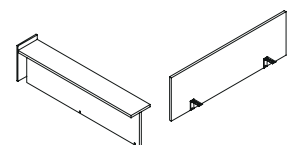





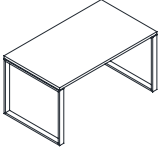



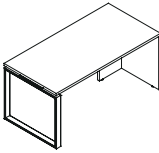



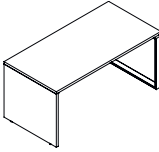



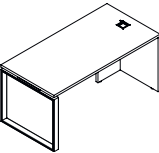

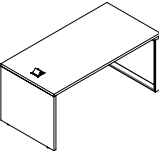

Dividers

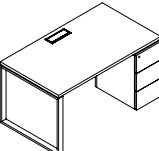

# Bat Office Workstation











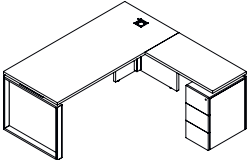





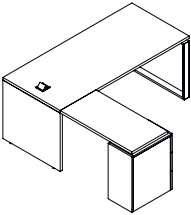





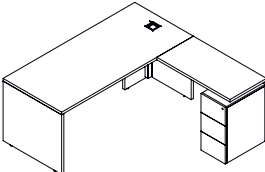

Francesc Rifé

DRAWING	SPECIFICATION	MEASURES mm	REF.	Euros
	<b><u>2 Open Legs</u></b>			
	Without top access. Table top of Melamine 30mm.	1400x800xH750mm E 1400x800mm  50kg	<b>R01/P</b>	1.286
		1600x800xH750mm E 1600x800mm  53kg	<b>R02/P</b>	1.312
		1800x800xH750mm E 1800x800mm  56kg	<b>R03/P</b>	1.350
	<b><u>Rigth Solid Leg</u></b>			
	1 open leg. Without top access. Without shelves in the front. Table top of Melamine 30mm.	1400x800xH750mm E 1400x800mm  55kg	<b>R01/D</b>	1.009
		1600x800xH750mm E 1600x800mm  58kg	<b>R02/D</b>	1.035
		1800x800xH750mm E 1800x800mm  61kg	<b>R03/D</b>	1.073
	<b><u>Left Solid Leg</u></b>			
	1 open leg. Sin top access. Without shelves in the front. Table top of Melamine 30mm.	1400x800xH750mm E 1400x800mm  42kg	<b>R01/I</b>	1.009
		1600x800xH750mm E 1600x800mm  45kg	<b>R02/I</b>	1.035
		1800x800xH750mm E 1800x800mm  48kg	<b>R03/I</b>	1.073
	<b><u>Rigth Solid Leg</u></b>			
	1 open leg. With top access + tray. Shelves in the front of the solid leg. Cable rise by cable duct in the solid leg. Table top of Melamine 30mm.	1400x800xH750mm E 1400x800mm  57kg	<b>R01/M</b>	1.378
		1600x800xH750mm E 1600x800mm  59kg	<b>R02/M</b>	1.401
		1800x800xH750mm E 1800x800mm  63kg	<b>R03/M</b>	1.441
	<b><u>Left Solid Leg</u></b>			
	1 open leg. With top access + tray. Shelves in the front of the solid leg. Cable rise by cable duct in the solid leg. Table top of Melamine 30mm.	1400x800xH750mm E 1400x800mm  43kg	<b>R04/M</b>	1.378
		1600x800xH750mm E 1600x800mm  46kg	<b>R05/M</b>	1.401
		1800x800xH750mm E 1800x800mm  49kg	<b>R06/M</b>	1.441
	<b><u>Pedestal of 3 Drawers</u></b>			
	1 open leg + buck ambidextrous. With top access + tray. Cable rise through the back of the buck (double bottom). Table top of Melamine 30mm.	1400x800xH750mm E 1400x800mm  63kg	<b>R01/B</b>	1.746
		1600x800xH750mm E 1600x800mm  66kg	<b>R02/B</b>	1.772
		1800x800xH750mm E 1800x800mm  69kg	<b>R03/B</b>	1.810

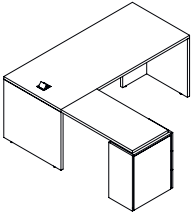
ATTENTION THE ELECTRICAL MODULES ARE NOT INCLUDED IN THE PRICE.

# Bat Office Workstation



Francesc Rifé

DRAWING	SPECIFICATION	MEASURES mm	REF.	Euros
	<b><u>With Right Add-on Table</u></b>			
	1 open leg + right solid leg. Right add-on table with support buck. With top access + tray. Shelves on the front of the solid leg. Cable rise by cable duct inside the solid leg. Table top of Melamine 30mm.	1400x1600xH750mm E 1400x800/Add-on table 800mm  91kg	<b>R13/M</b>	2.844
		1400x1800xH750mm E 1400x800/Add-on table 1000mm  93kg	<b>R14/M</b>	2.867
		1600x1600xH750mm E 1600x800/Add-on table 800mm  94kg	<b>R15/M</b>	2.872
		1600x1800xH750mm E 1600x800/Add-on table 1000mm  97kg	<b>R16/M</b>	2.897
		1800x1600xH750mm E 1800x800/Add-on table 800mm  99kg	<b>R17/M</b>	2.918
		1800x1800xH750mm E 1800x800/Add-on table 1000mm  102kg	<b>R18/M</b>	2.930
	<b><u>With Left Add-on Table</u></b>			
	1 open leg + left solid leg. Left add-on table with support buck. With top access + tray. Shelves on the front of the solid leg. Cable rise by cable duct inside the solid leg. Table top of Melamine 30mm.	1400x1600xH750mm E 1400x800/ Add-on table 800mm  91kg	<b>R19/M</b>	2.844
		1400x1800xH750mm E 1400x800/Add-on table 1000mm  93kg	<b>R20/M</b>	2.867
		1600x1600xH750mm E 1600x800/Add-on table 800mm  94kg	<b>R21/M</b>	2.872
		1600x1800xH750mm E 1600x800/ Add-on table 1000mm  97kg	<b>R22/M</b>	2.897
		1800x1600xH750mm E 1800x800/Add-on table 800mm  99kg	<b>R23/M</b>	2.918
		1800x1800xH750mm E 1800x800/Add-on table 1000mm  102kg	<b>R24/M</b>	2.930
	<b><u>With Right Add-on Table</u></b>			
	2 solid legs. Right add-on table with support buck. With top access + tray. Shelves on the front of the solid leg. Cable rise by cable duct inside the solid leg. Table top of Melamine 30mm.	1400x1600xH750mm E 1400x800/Add-on table 800mm  96kg	<b>R25/M</b>	2.554
		1400x1800xH750mm E 1400x800/Add-on table 1000mm  98kg	<b>R26/M</b>	2.567
		1600x1600xH750mm E 1600x800/Add-on table 800mm  99kg	<b>R27/M</b>	2.577
		1600x1800xH750mm E 1600x800/Add-on table 1000mm  102kg	<b>R28/M</b>	2.597
		1800x1600xH750mm E 1800x800/Add-on table 800mm  104kg	<b>R29/M</b>	2.602
		1800x1800xH750mm E 1800x800/Add-on table 1000mm  102kg	<b>R30/M</b>	2.620
	<b><u>With Left Add-on Table</u></b>			
	2 solid legs. Left add-on table with support buck. With top access + tray. Shelves on the front of the solid leg. Cable rise by cable duct inside the solid leg. Table top of Melamine 30mm.	1400x1600xH750mm E 1400x800/Add-on table 800mm  96kg	<b>R31/M</b>	2.554
		1400x1800xH750mm E 1400x800/Add-on table 1000mm  98kg	<b>R32/M</b>	2.567
		1600x1600xH750mm E 1600x800/Add-on table 800mm  99kg	<b>R33/M</b>	2.577
		1600x1800xH750mm E 1600x800/Add-on table 1000mm  102kg	<b>R34/M</b>	2.597
		1800x1600xH750mm E 1800x800/Add-on table 800mm  104kg	<b>R35/M</b>	2.602
		1800x1800xH750mm E 1800x800/Add-on table 1000mm  107kg	<b>R36/M</b>	2.620





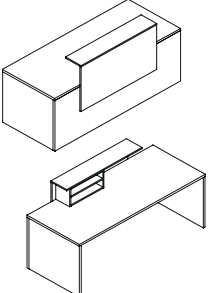





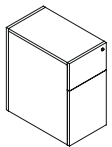

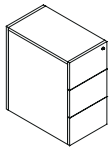

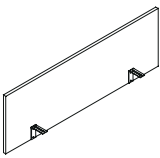
NOTE: ALL THE WORKSTATIONS WITH TOP ACCESS INCLUDE CABLE RISER DUCT AND METAL TRAY TO ALLOCATE THE ELECTRIFICATION KITS. ELECTRICAL MODULES ARE NOT INCLUDED.

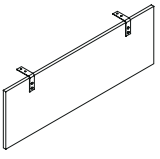
# Bat Office Workstation

Francesc Rifé

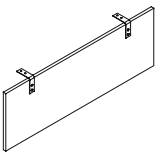





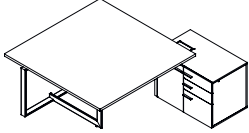

DRAWING	SPECIFICATION	MEASURES mm	REF.	€uros
	<p><b>Reception Desk</b></p> <p>With front and side modesty panels included. Table top of Melamine 30mm.</p>	1800x830mm H1031mm	 115kg	<b>H60/M</b> 2.877
		2000x830mm H1031mm	 122kg	<b>H61/M</b> 2.981

## ACCESSORIES

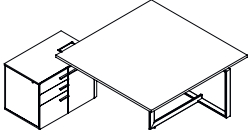
DRAWING	SPECIFICATION	MEASURES mm	REF.	€uros
	<p><b>DRAWER + FILE WITH CASTORS</b> Melamine 20mm.</p>	330x565mm H655mm	 24kg	<b>A15/M</b> 610
	<p><b>3 DRAWERS WITH CASTORS</b> Melamine 20mm.</p>	330x565mm H655mm	 26kg	<b>A16/M</b> 610
	<p><b>DIVIDER FOR INDIVIDUAL WORKSTATION</b> Table 1400mm (Melamine)</p>	1250x19mm H410mm	 5,0kg	<b>A55/M</b> 161
	<p><b>DIVIDER FOR INDIVIDUAL WORKSTATION</b> Table 1600/1800mm (Melamine)</p>	1480x19mm H410mm	 6,0kg	<b>A56/M</b> 184
	<p><b>MODESTY PANEL FOR INDIVIDUAL WORKSTATION</b> Table 1400mm 2 solid leg (Melamine)</p>	644x19mm H383mm	 2,5kg	<b>A30/M</b> 163
	<p><b>MODESTY PANEL FOR INDIVIDUAL WORKSTATION</b> Table 1600mm 2 solid leg (Melamine)</p>	844x19mm H383mm	 3,5kg	<b>A31/M</b> 173
	<p><b>MODESTY PANEL FOR INDIVIDUAL WORKSTATION</b> Table 1800mm 2 solid leg (Melamine)</p>	1044x19mm H383mm	 4,0kg	<b>A76/M</b> 183
	<p><b>MODESTY PANEL FOR INDIVIDUAL WORKSTATION</b> Table 1400mm solid leg + open leg (Melamine)</p>	940x19mm H383mm	 3,8kg	<b>A80/M</b> 163
	<p><b>MODESTY PANEL FOR INDIVIDUAL WORKSTATION</b> Table 1600mm solid leg + open leg (Melamine)</p>	1140x19mm H383mm	 4,5kg	<b>A81/M</b> 173
	<p><b>MODESTY PANEL FOR INDIVIDUAL WORKSTATION</b> Table 1800mm solid leg + open leg (Melamine)</p>	1340x19mm H383mm	 5,2kg	<b>A82/M</b> 183

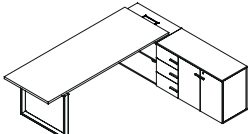
# Bat Office Executive

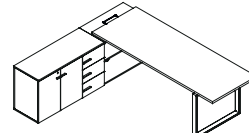









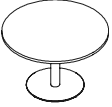



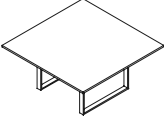

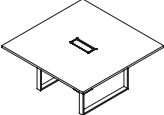
Francesc Rifé

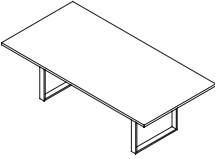
DRAWING	SPECIFICATION	MEASURES mm	REF.	€uros
	<p><b>Right Cabinet</b></p> <p>Cabinet with 3 drawers and lockable door. Rise cables inside the cabinet. With top access in cabinet. Table top of Melamine 30mm.</p>	1875x1786xH750mm E 1400x1400mm  134kg	<b>R60/M</b>	5.550
		2075x1986xH750mm E 1600x1600mm  144kg	<b>R61/M</b>	5.949
	<p><b>Left Cabinet</b></p> <p>Cabinet with 3 drawers and lockable door. Rise cables inside the cabinet. With top access in cabinet. Table top of Melamine 30mm.</p>	1875x1786xH750mm E 1400x1400mm  134kg	<b>R62/M</b>	5.550
		2075x1986xH750mm E 1600x1600mm  144kg	<b>R63/M</b>	5.949
	<p><b>Right Furniture</b></p> <p>Furniture with diaphanous buck prepared for cable rise. Buck of 3 drawers, cabinet with 2 doors and inside shelves and lock. With top access in cabinet. Table top of Melamine 30mm.</p>	2230x2000xH750mm E 2000x800mm  156kg	<b>R64/M</b>	5.382
		2430x2000xH750mm E 2200x800mm  162kg	<b>R65/M</b>	5.550
	<p><b>Left Furniture</b></p> <p>Furniture with diaphanous buck prepared for cable rise. Buck of 3 drawers, cabinet with 2 doors and inside shelves and lock. With top access in cabinet. Table top of Melamine 30mm.</p>	2230x2000xH750mm E 2000x800mm  156kg	<b>R66/M</b>	5.382
		2430x2000xH750mm E 2200x800mm  162kg	<b>R67/M</b>	5.550

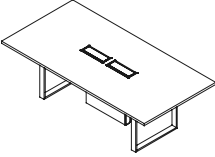
NOTE: THE EXECUTIVE TABLES INCLUDE CABLE RISER DUCT AND METAL TRAY TO ALLOCATE THE ELECTRIFICATION KITS. ELECTRICAL MODULES ARE NOT INCLUDED.

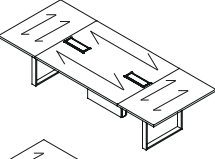
# Bat Office Meeting

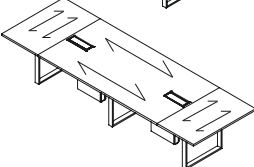

Francesc Rifé

DRAWING	SPECIFICATION	MEASURES mm	REF.	Euros	
	Central column. Table top of Melamine 30mm.	Ø800mm H750mm	 55kg	<b>H0Q/M</b> 1.037	
		Ø1000mm H750mm	 61kg	<b>H0S/M</b> 1.136	
		Ø1200mm H750mm	 69kg	<b>H0T/M</b> 1.233	
	Without top access. Table top of Melamine 30mm.	1400x1400mm H750mm	 64kg	<b>H0X/M</b> 1.360	
		1600x1600mm H750mm	 75kg	<b>H0Y/M</b> 1.601	
	Totem not included. Table top of Melamine 30mm.	1400x1400mm H750mm	 64kg	<b>H0Z/M</b> 1.845	
		1600x1600mm H750mm	 75kg	<b>H1A/M</b> 2.092	
	Without top access. Table top of Melamine 30mm.	2400x1200mm H750mm	 86kg	<b>H1B/M</b> 1.601	
		2800x1200mm H750mm	 96kg	<b>H1C/M</b> 1.726	
	<b>Rectangular + 2 Top Access</b>	With square totem included. Table top of Melamine 30mm.	2400x1200mm H750mm	 96kg	<b>H1D/M</b> 2.402
	<b>Rectangular + 2 Top Access</b>	With square totem included. Table top of Melamine 30mm.	3000x1200mm H750mm	 108kg	<b>H1E/M</b> 3.078
	<b>Rectangular + 2 Top Access</b>	With square totem included. Table top of Melamine 30mm.	3700x1200mm H750mm	 141kg	<b>H1F/M</b> 4.231

ATTENTION THE ELECTRICAL MODULES ARE NOT INCLUDED.

↑ Wood grain orientation











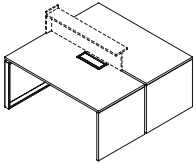



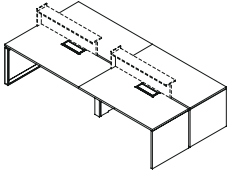

## ACCESSORIES

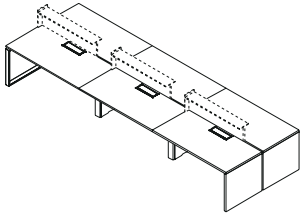
DRAWING	SPECIFICATION	REF.	Euros
	<b>FLEXIBLE CABLE RISER</b> white or black	<b>A34/M</b>	92
	<b>SQUARE TOTEM FOR CABLE RISE</b> 100x100mm	<b>A71/M</b>	289

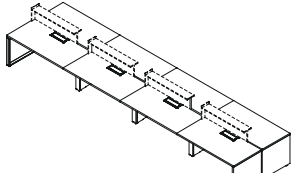

# Bat Office Bench











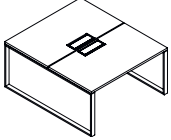



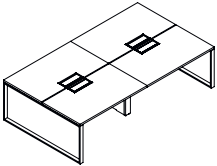

Francesc Rifé

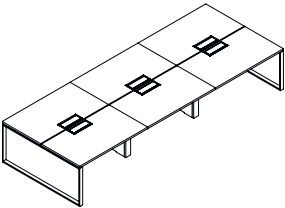
DRAWING	SPECIFICATION	MEASURES mm	REF.	€uros
	<p><b>2 Seater</b></p> <p>Solid legs with 2 top access + tray (1100mm). Table top of Melamine 30mm.</p>	1400x1600xH750mm E 1400x800mm (2)  91,0kg	<b>R70/M</b>	2.178
		1600x1600xH750mm E 1600x800mm (2)  101kg	<b>R71/M</b>	2.254
		1800x1600xH750mm E 1800x800mm (2)  108kg	<b>R72/M</b>	2.323
	<p><b>4 Seater</b></p> <p>Solid legs with 4 top access + 2 trays (1100mm) + square totem. Table top of Melamine 30mm.</p>	2800x1600xH750mm E 1400x800mm (4)  185kg	<b>R73/M</b>	4.630
		3200x1600xH750mm E 1600x800mm (4)  202kg	<b>R74/M</b>	4.770
		3600x1600xH750mm E 1800x800mm (4)  215kg	<b>R75/M</b>	4.910
	<p><b>6 Seater</b></p> <p>Solid legs with 6 top access + 3 trays (1100mm) + 2 square totems. Table top of Melamine 30mm.</p>	4200x1600xH750mm E 1400x800mm (6)  248kg	<b>R76/M</b>	7.062
		4800x1600xH750mm E 1600x800mm (6)  268kg	<b>R77/M</b>	7.283
		5400x1600xH750mm E 1800x800mm (6)  286kg	<b>R78/M</b>	7.491
	<p><b>8 Seater</b></p> <p>Solid legs with 8 top access + 4 trays (1100mm) + 3square totems. Table top of Melamine 30mm.</p>	5600x1600xH750mm E 1400x800mm (8)  317kg	<b>R79/M</b>	9.506
		6400x1600xH750mm E 1600x800mm (8)  342kg	<b>R80/M</b>	9.783
		7200x1600xH750mm E 1800x800mm (8)  370kg	<b>R81/M</b>	10.060

ATTENTION THE DIVIDERS ARE NOT INCLUDED IN THE PRICE.

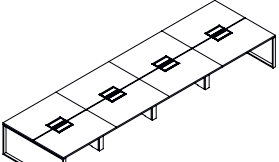
# Bat Office Bench

Francesc Rifé







DRAWING	SPECIFICATION	MEASURES mm	REF.	Euros
	<p><b>2 Seater</b></p> <p>2 open legs with 2 top access + tray (1100mm). Table top of Melamine 30mm.</p>	1400x1600xH750mm E 1400x800mm (2)  96,0kg	<b>B70/M</b>	2.564
		1600x1600xH750mm E 1600x800mm (2)  102kg	<b>B71/M</b>	2.638
		1800x1600xH750mm E 1800x800mm (2)  108kg	<b>B72/M</b>	2.707
	<p><b>4 Seater</b></p> <p>2 open legs with 4 top access + 2 trays (1100mm) + square totem. Table top of Melamine 30mm.</p>	2800x1600xH750mm E 1400x800mm (4)  165kg	<b>B73/M</b>	5.014
		3200x1600xH750mm E 1600x800mm (4)  177kg	<b>B74/M</b>	5.154
		3600x1600xH750mm E 1800x800mm (4)  189kg	<b>B75/M</b>	5.293
	<p><b>6 Seater</b></p> <p>2 open legs with 6 top access + 3 trays (1100mm) + 2 square totems. Table top of Melamine 30mm.</p>	4200x1600xH750mm E 1400x800mm (6)  234kg	<b>B76/M</b>	7.446
		4800x1600xH750mm E 1600x800mm (6)  252kg	<b>B77/M</b>	7.667
		5400x1600xH750mm E 1800x800mm (6)  270kg	<b>B78/M</b>	7.878
	<p><b>8 Seater</b></p> <p>2 open legs with 8 top access + 4 trays (1100mm) + 3 square totems. Table top of Melamine 30mm.</p>	5600x1600xH750mm E 1400x800mm (8)  303kg	<b>B79/M</b>	9.890
		6400x1600xH750mm E 1600x800mm (8)  327kg	<b>B80/M</b>	10.167
		7200x1600xH750mm E 1800x800mm (8)  351kg	<b>B81/M</b>	10.444

ATTENTION THE DIVIDERS ARE NOT INCLUDED IN THE PRICE.

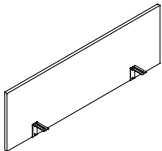
# Bat Office Bench

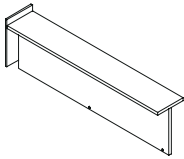
Francesc Rifé

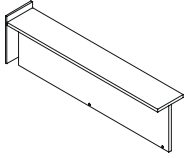

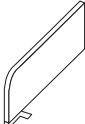

## ACCESSORIES

DRAWING	SPECIFICATION	MEASURES mm	REF.	€uros	REF.	€uros	
<b>SOLID LEG / 2 OPEN LEGS</b>							
	<b>DIVIDERS FOR BENCH</b> Table 1400mm	1250x19mm H410mm	 7,0kg  7,5kg	<b>R82/M</b>	183	<b>R82/B</b>	593
						<b>DIVIDERS FOR BENCH</b> Table 1600/1800mm	1450x19mm H410mm
	<b>SOLID LEG</b>						
		<b>DIVIDERS T FOR BENCH</b> Table 1400mm	996x202mm H379mm	 10,0kg  10,5kg	<b>R85/M</b>	260	<b>R85/B</b>
<b>DIVIDERS T FOR BENCH</b> Table 1600/1800mm							1196x202mm H379mm
		<b>2 OPEN LEGS</b>					
		<b>DIVIDERS T FOR BENCH</b> Table 1400mm	996x202mm H379mm	 10,0kg  10,5kg	<b>B85/M</b>	260	<b>B85/B</b>
	<b>DIVIDERS T FOR BENCH</b> Table 1600/1800mm						1196x202mm H379mm
		<b>R88/M</b>	570				
	<b>PRICE INCREASE LED Dividers T</b> (price per divider)						
	<b>SIDE DIVIDER FOR WORKSTATION AND BENCH</b>	600x340mm H30mm			<b>Melamine</b>	<b>Upholstered Group D, C, B &amp; A</b>	
			<b>R95/M</b>	176	<b>R96/M</b>	346	

# Bat Office Bench

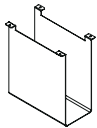
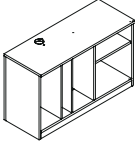
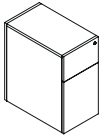

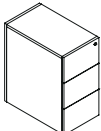







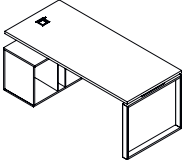

Francesc Rifé

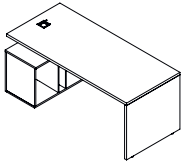
## ACCESSORIES

DRAWING	SPECIFICATION	MEASURES mm	REF.	€uros	REF.	€uros
	<b>CPU HOLDER</b>		<b>A72/M</b>	241		
	<b>PEDESTAL</b> With lacquered accessory for cable rise and cable grommet	970x380mm H584mm			With castors	Without castors
			<b>R90/M</b>	826	<b>R91/M</b>	826
	<b>DRAWER + FILE WITH CASTORS</b> Melamine 20mm.	330x565mm H655mm	 24kg	<b>A15/M</b>	610	
	<b>3 DRAWERS WITH CASTORS</b> Melamine 20mm.	330x565mm H655mm	 26kg	<b>A16/M</b>	610	

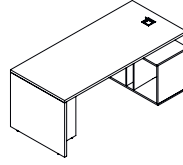





# Bat Office Spine

Francesc Rifé

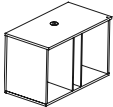
DRAWING	SPECIFICATION	MEASURES mm	REF.	€uros
	<p><b>Open Leg</b></p> <p>With pedestal. Pedestal with 30mm melamine divider with double bottom for cable rise. Table top with top access.</p>	1400x840xH750mm E 1400x800mm	 57kg	<b>R37/M</b> 1.990
		1600x840xH750mm E 1600x800mm	 60kg	<b>R38/M</b> 2.028
		1800x840xH750mm E 1800x800mm	 68kg	<b>R39/M</b> 2.064
	<p><b>Right Solid Leg</b></p> <p>With left pedestal. Pedestal with 30mm melamine divider with double bottom for cable rise. Table top with top access.</p>	1400x840xH750mm E 1400x800mm	 62kg	<b>R40/M</b> 1.746
		1600x840xH750mm E 1600x800mm	 65kg	<b>R41/M</b> 1.769
		1800x840xH750mm E 1800x800mm	 68kg	<b>R42/M</b> 1.792
	<p><b>Left Solid Leg</b></p> <p>With right pedestal. Pedestal with 30mm melamine divider with double bottom for cable rise. Table top with top access.</p>	1400x840xH750mm E 1400x800mm	 62kg	<b>R43/M</b> 1.746
		1600x840xH750mm E 1600x800mm	 65kg	<b>R44/M</b> 1.769
		1800x840xH750mm E 1800x800mm	 68kg	<b>R45/M</b> 1.792

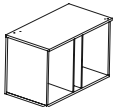
NOTE: ALL THE WORKSTATIONS WITH TOP ACCESS INCLUDE CABLE RISER DUCT AND METAL TRAY TO ALLOCATE THE ELECTRIFICATION KITS. ELECTRICAL MODULES ARE NOT INCLUDED.

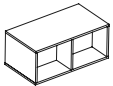
## ACCESSORIES

DRAWING	SPECIFICATION	MEASURES mm	REF.	€uros
	<p><b>SPINE COMPOSITION STORAGE CABINET WITH CABLE RISER DUCT WITH GROMMET</b> 20mm melamine divider with double bottom for cable rise.</p>	840x460mm H550mm	 27kg	<b>R46/M</b> 727
	<p><b>SPINE COMPOSITION STORAGE CABINET</b> 20mm melamine divider with double bottom for cable rise.</p>	840x460mm H550mm	 27kg	<b>R47/M</b> 717
	<p><b>SPINE COMPOSITION STORAGE WITH 1 DRAWER</b></p>	400x460mm H550mm	 14kg	<b>R49/M</b> 471
	<p><b>SPINE COMPOSITION LOW STORAGE</b> With upholstered cushion Group D, C, B &amp; A.</p>	840x460mm H400mm	 22kg	<b>R52/M</b> 829

---

# *Bat Executive*

Francesc Rifé



A desk to work at and meet around. There's always space for more knowledge. Bat is united around an objective. Bat Executive is a space open to weighing up opinions, to hearing new ideas and leading new projects. The key lies in the union. Everything is easier if you know others are behind you.

Special for its simplicity, Bat has been created so that ideas can flow, so that people can share their knowledge and generate synergies. The difference lies in the details: walnut wood and leather finish; steel sled legs in painted steel...

---

# Bat Executive

Francesc Rifé

---

## TABLE TOPS

Table top made of a double layer of 60mm (2 3/8") thick MDF board creating a 3 mm (1/16") edge with integrated top access veneered in natural wood with acrylic matt UV protection varnish available in several finishes.

Table surface upholstered in Eco leather in several finishes.

Powder coated steel frame structure integrated underneath the desk surface.

---

## WOOD TABLE TOPS

AKABA S.A. will not be responsible for the total uniformity and similarity in the tables that have more than one table top. The nature of this finish, its diversity of veins, tones and shades from one sheet to another, mean that exact uniformity cannot be guaranteed.

---

## U-SHAPED LEG/COLUMN LEG

U-shaped leg in 2 mm (1/16") thick steel measuring 80x20 mm (3 1/8" x 3/4"), powder coated, with leveling glides.

---

## BOOKCASE CABINET AND BOOKCASE PEDESTAL

Table supported bookcase cabinet made of 20 mm (3/4") thick MDF board veneered in natural wood with acrylic matte UV protection varnish available in several finishes. The bookcase cabinet is elevated. External part with bookcases and lacquered book ends and dividers. Internal part with a door to accommodate a briefcase or bin, 3 drawers provided with pencil case in wood, lock and metal drawer slides with automatic drawer closing system. Sliding door.

Pedestal made of a 20 mm (3/4") thick MDF board veneered in natural wood with acrylic matte UV protection varnish available in several finishes. The bookcase pedestal is elevated. External part with bookcases and lacquered bookends and dividers. Internal part with 3 drawers provided with wood pencil case, lock and drawer slides with automatic drawer closing system. Provided with a door to accommodate a briefcase or bin.

---

## ELECTRIFICATION SYSTEM

Integrated cable management system in all technical furniture. The access to the electrical outlets is on the inside of the furniture and cable risers and cable trays are provided.

---

## MEETING AND BOARD ROOM TABLES

Table top made of a double layer of 60 mm (2 3/8") thick MDF board creating a 3 mm (1/16") edge with integrated top access veneered in natural wood with acrylic matt UV protection varnish available in several finishes.

U-shaped leg in 2 mm (1/16") thick steel measuring 80x20 mm (3 1/8" x 3/4"), powder coated, with leveling glides. Powder coated steel frame structure integrated underneath the desk surface.

The cable management system is designed through a central column in textured, lacquered MDF with access for cable rising with cable tray for electrical units. Top access from table tops.

---

## BOOK CASE CABINETS

Modular bookcases in 2 different heights with swing doors. Outside done in 20 mm (3/4") thick MDF board veneered in natural wood with acrylic matte UV protection varnish available in several finishes. Inside in graphite. Floor leveling glides. Locks and handles available.

Book shelving with graphite back and 3 shelves of 40mm (1 1/2") thick MDF veneered in natural wood with acrylic matte UV protection varnish available in several finishes.

# Bat Executive

Francesc Rifé

## EXECUTIVE WORK DESKS

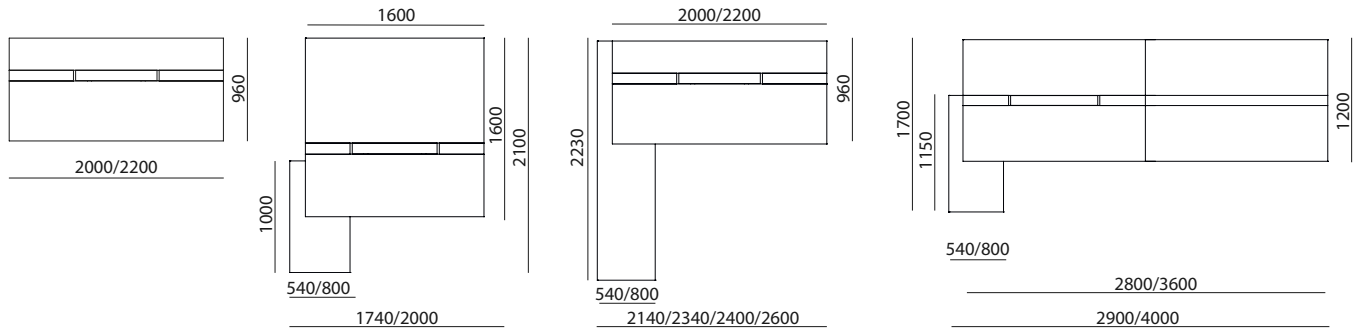



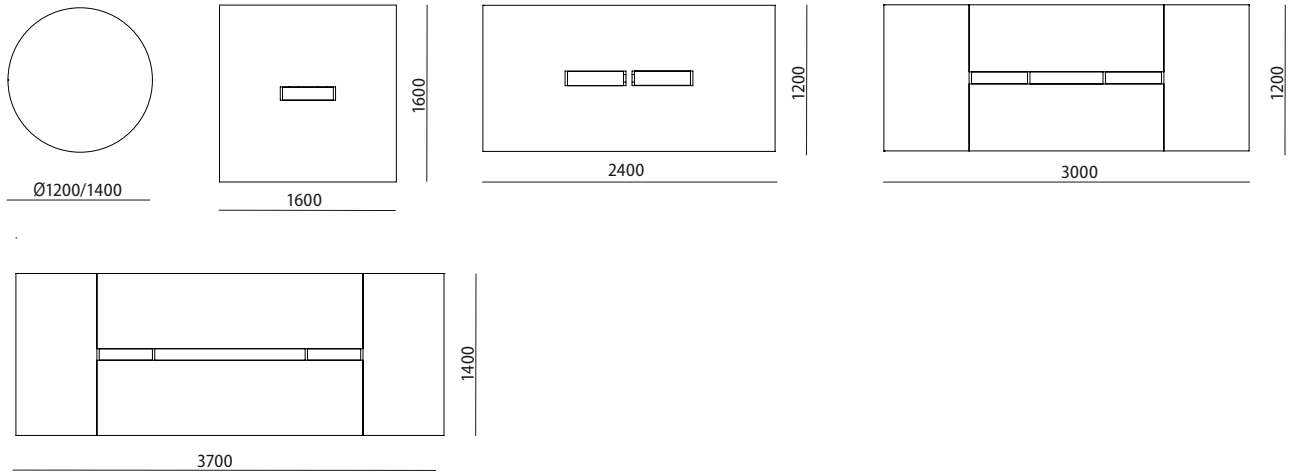





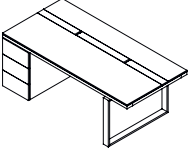

## MEETING TABLES

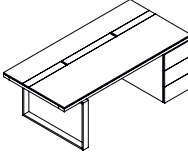

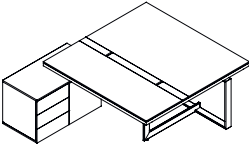

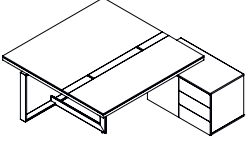
# Bat Executive Work Desk

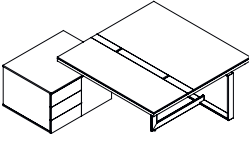
Francesc Rifé









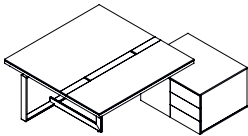

DRAWING	SPECIFICATION	MEASURES mm	REF.	€uros
	<p><b><u>Left Pedestal</u></b></p> <p>1 open leg + buck of 3 drawers. With wooden top access in veneered wood table top. Table surface upholstered in Eco-leather. Cable tray under table top, and Cable rise through the back of the buck (double bottom).</p>	2000x960mm H750mm	 85kg	<b>T01/M</b> 8.782
		2200x960mm H750mm	 88kg	<b>T02/M</b> 9.057
	<p><b><u>Right Pedestal</u></b></p> <p>1 open leg + buck of 3 drawers. With wooden top access in veneered wood table top. Table surface upholstered in Eco-leather. Cable tray under table top, and Cable rise through the back of the buck (double bottom).</p>	2000x960mm H750mm	 85kg	<b>T03/M</b> 8.782
		2200x960mm H750mm	 88kg	<b>T04/M</b> 9.057
	<p><b><u>Left Pedestal</u></b></p> <p>1 open leg + pedestal. Pedestal with 3 drawers and door with lock. With wooden top access in veneered wood table top. Table surface upholstered in Eco-leather. Cable tray under table top. Cable rise inside the pedestal.</p>	1740x2100xH750mm E 1600x1600mm	 144kg	<b>T05/M</b> 11.798
	<p><b><u>Right Pedestal</u></b></p> <p>1 open leg + pedestal. Pedestal with 3 drawers and door with lock. With wooden top access in veneered wood table top. Table surface upholstered in Eco-leather. Cable tray under table top. Cable rise inside the pedestal.</p>	1740x2100xH750mm E 1600x1600mm	 144kg	<b>T06/M</b> 11.798
	<p><b><u>Left Pedestal + Bookcase</u></b></p> <p>1 open leg + pedestal. Pedestal with 3 drawers and door with lock. With wooden top access in veneered wood table top. Table surface upholstered in Eco-leather. Cable tray under table top. Cable rise inside the pedestal.</p>	1740x2100xH750mm E 1600x1600mm	 146kg	<b>T07/M</b> 12.484

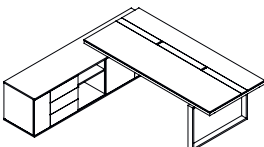
NOTE: MODESTY PANELS AVAILABLE. CONTACT WITH THE FACTORY..

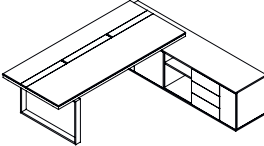
WOODEN TABLE TOPS: AKABA S.A. will not be responsible for the total uniformity and similarity in the tables that have more than one table top. The nature of this finish, its diversity of venis, tones and shades from one sheet to another, mean that exact uniformity cannot be guaranteed.

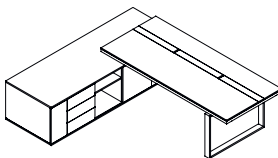
# Bat Executive Work Desk

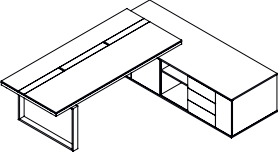
Francesc Rifé







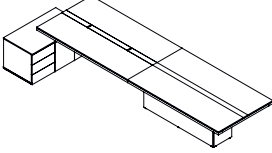

DRAWING	SPECIFICATION	MEASURES mm	REF.	Euros
	<p><b><u>Right Pedestal + Bookcase</u></b></p> <p>1 open leg + pedestal. Pedestal with 3 drawers and door with lock. With wooden top access in veneered wood table top. Table surface upholstered in Eco-leather. Cable tray under table top. Cable rise inside the pedestal.</p>		<p>1740x2100xH750mm E 1600x1600mm</p> <p> 146kg</p>	<p><b>T08/M</b> 12.484</p>
		<p><b><u>Left Cabinet</u></b></p> <p>Table supported bookcase with sliding door prepared for cable rise + pedestal of 3 drawers + door with lock. cable rise inside the furniture. With wooden top access in veneered wood table top. Table surface upholstered in Eco-leather. Cable tray under table top.</p>		<p>2140x2230xH750mm E 2000x960mm</p> <p> 163kg</p> <p>2340x2230xH750mm E 2200x960mm</p> <p> 167kg</p>
		<p><b><u>Right Cabinet</u></b></p> <p>Table supported bookcase with sliding door prepared for cable rise + pedestal of 3 drawers + door with lock. cable rise inside the furniture. With wooden top access in veneered wood table top. Table surface upholstered in Eco-leather. Cable tray under table top.</p>		<p>2140x2230xH750mm E 2000x960mm</p> <p> 163kg</p> <p>2340x2230xH750mm E 2200x960mm</p> <p> 167kg</p>
		<p><b><u>Left Cabinet + Bookcase</u></b></p> <p>Table supported bookcase with sliding door prepared for cable rise + pedestal of 3 drawers + door with lock. cable rise inside the furniture. With wooden top access in veneered wood table top. Table surface upholstered in Eco-leather. Cable tray under table top.</p>		<p>2400x2230xH750mm E 2000x960mm</p> <p> 170kg</p> <p>2600x2230xH750mm E 2200x960mm</p> <p> 175kg</p>
		<p><b><u>Right Cabinet + Bookcase</u></b></p> <p>Table supported bookcase with sliding door prepared for cable rise + pedestal of 3 drawers + door with lock. cable rise inside the furniture. With wooden top access in veneered wood table top. Table surface upholstered in Eco-leather. Cable tray under table top.</p>		<p>2400x2230xH750mm E 2000x960mm</p> <p> 170kg</p> <p>2600x2230xH750mm E 2200x960mm</p> <p> 175kg</p>

NOTE: MODESTY PANELS AVAILABLE. CONTACT WITH THE FACTORY.

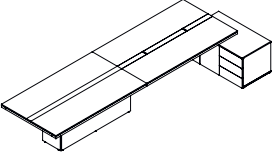
WOODEN TABLE TOPS: AKABA S.A. will not be responsible for the total uniformity and similarity in the tables that have more than one table top. The nature of this finish, its diversity of venis, tones and shades from one sheet to another, mean that exact uniformity cannot be guaranteed.

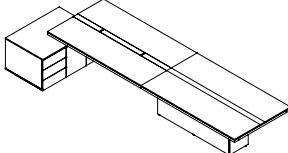
# Bat Executive Work + Meeting Desk

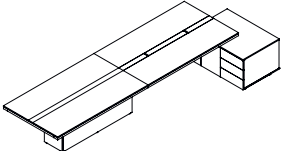
Francesc Rifé







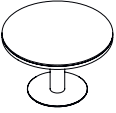

DRAWING	SPECIFICATION	MEASURES mm	REF.	€uros
	<p><b>Left Pedestal</b></p> <p>Pedestal of 3 drawers and door with lock. Cable rise inside the pedestal. With wooden top access in veneered wood table top. Table surface upholstered in Eco-leather. Cable tray under table top.</p>	2940x1700xH750mm E 2800x1200mm  173kg	<b>T17/M</b>	15.752
		3740x1700xH750mm E 3600x1200mm  193kg	<b>T18/M</b>	17.218
	<p><b>Right Pedestal</b></p> <p>Pedestal of 3 drawers and door with lock. Cable rise inside the pedestal. With wooden top access in veneered wood table top. Table surface upholstered in Eco-leather. Cable tray under table top.</p>	2940x1700xH750mm E 2800x1200mm  173kg	<b>T19/M</b>	15.752
		3740x1700xH750mm E 3600x1200mm  193kg	<b>T20/M</b>	17.218
	<p><b>Left Pedestal + Bookcase</b></p> <p>Pedestal of 3 drawers and door with lock. Cable rise inside the pedestal. With wooden top access in veneered wood table top. Table surface upholstered in Eco-leather. Cable tray under table top.</p>	3200x1700xH750mm E 2800x1200mm  185kg	<b>T43/M</b>	16.436
		4000x1700xH750mm E 3600x1200mm  202kg	<b>T44/M</b>	17.904
	<p><b>Right Pedestal + Bookcase</b></p> <p>Pedestal of 3 drawers and door with lock. Cable rise inside the pedestal. With wooden top access in veneered wood table top. Table surface upholstered in Eco-leather. Cable tray under table top.</p>	3200x1700xH750mm E 2800x1200mm  185kg	<b>T45/M</b>	16.436
		4000x1700xH750mm E 3600x1200mm  202kg	<b>T46/M</b>	17.904

NOTE: MODESTY PANELS AVAILABLE. CONTACT WITH THE FACTORY.

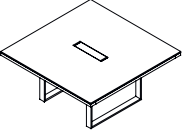
WOODEN TABLE TOPS: AKABA S.A. will not be responsible for the total uniformity and similarity in the tables that have more than one table top. The nature of this finish, its diversity of venis, tones and shades from one sheet to another, mean that exact uniformity cannot be guaranteed.

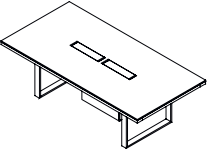
# Bat Executive Meeting Desk

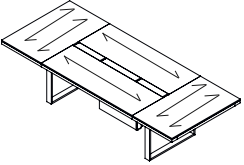
Francesc Rifé

DRAWING	SPECIFICATION	MEASURES mm	REF.	Euros
	<p><u>Round</u></p> <p>Veneered wood table top.</p>	Ø1200mm H750mm  58kg	<b>T21/M</b>	4.003
		Ø1400mm H750mm  67kg	<b>T22/M</b>	4.658
	<p><u>Square</u></p> <p>With wooden top access. Veneered wood table top.</p>	1600x1600mm H750mm  85kg	<b>T23/M</b>	5.537
	<p><u>Rectangular + 2 Wooden Top Access</u></p> <p>With central totem included. Veneered wood table top.</p>	2400x1200mm H750mm  108kg	<b>T24/M</b>	6.996
	<p><u>Rectangular + 2 Wooden Top Access</u></p> <p>With central totem included. Veneered wood table top.</p>	3000x1200mm H750mm  123kg	<b>T25/M</b>	9.687
		3700x1400mm H750mm  155kg	<b>T26/M</b>	13.356

↓ Wood grain orientation

ATTENTION THE ELECTRICAL MODULES ARE NOT INCLUDED.

FOR MEETING TABLES WITH SPECIAL MEASURES, CONTACT WITH THE FACTORY.

WOODEN TABLE TOPS: AKABA S.A. will not be responsible for the total uniformity and similarity in the tables that have more than one table top. The nature of this finish, its diversity of venis, tones and shades from one sheet to another, mean that exact uniformity cannot be guaranteed.

---

# Zubi



Range of cabinets with an extraordinarily flexible composition. Simple lines, numerous combinations and excellent adaptation to all needs. The detachable connections make it easy to change the distribution of the architectural spaces and the modules with their fully finished backs simplify the task by doubling as dividers when required.

Inside, the cabinets are fully designed for flexibility: the units come with levelling feet accessible from the interior, fixed or mobile shelves, doors which can be regulated and adjusted, with hinges opening to 110°... Zubi thinks of all details, creating filing solutions for hanging folders, with a pull-out frame. If we add to all of this the quality and durability of their materials, each of the components in these cabinets becomes a guarantee of success.

# Zubi

## HEIGHT 750mm

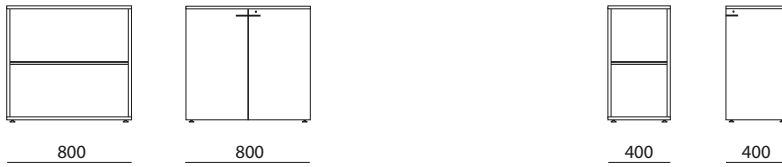

## HEIGHT 1165mm

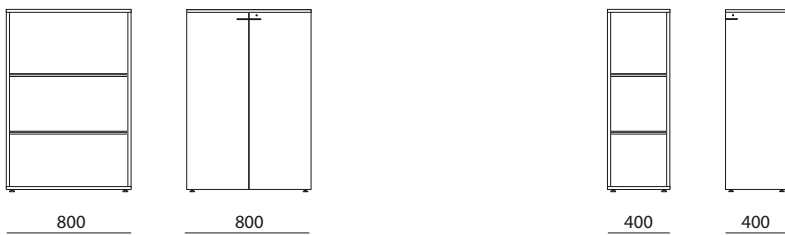



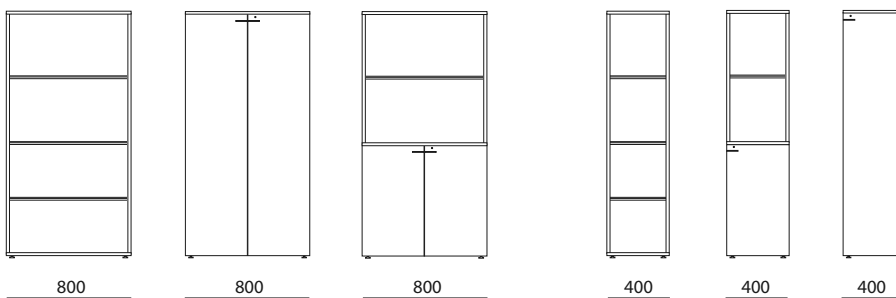



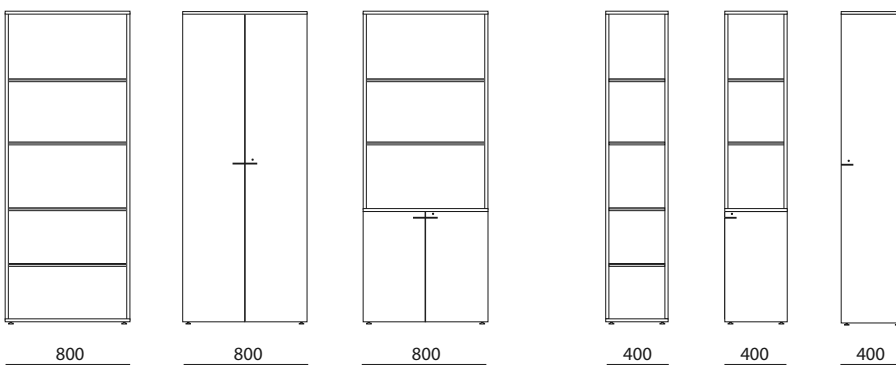

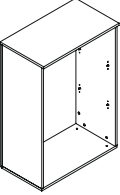

## HEIGHT 1580mm

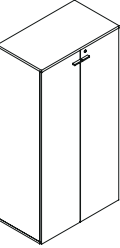

## HEIGHT 2000mm



# Zubi

DRAWING	SPECIFICATION	MEASURES mm	REF.	€uros	REF.	€uros	€uros
	<b>Diaphanous</b>						
	Top included. Shelves not included.	800x460mm H750mm	 20kg	<b>Z01/M</b> 432	<b>Z01/W</b> 809	<b>Z01/C</b> 1.530	
		800x460mm H1165mm	 28kg	<b>Z03/M</b> 519	<b>Z03/W</b> 903	<b>Z03/C</b> 1.927	
		800x460mm H1580mm	 37kg	<b>Z05/M</b> 557	<b>Z05/W</b> 931	<b>Z05/C</b> 2.323	
	800x460mm H2000mm	 46kg	<b>Z09/M</b> 674	<b>Z09/W</b> 1.050	<b>Z09/C</b> 2.719		
	<b>With Doors (*)</b>						
	Top included. Shelves not included. With handles and lock.	800x460mm H750mm	 27kg	<b>Z02/M</b> 623	<b>Z02/W</b> 1.634	<b>Z02/C</b> 2.183	69
		800x460mm H1165mm	 40kg	<b>Z04/M</b> 725	<b>Z04/W</b> 1.980	<b>Z04/C</b> 2.773	102
		800x460mm H1580mm	 53kg	<b>Z08/M</b> 831	<b>Z08/W</b> 2.348	<b>Z08/C</b> 3.362	102
		800x460mm H2000mm Fixed shelf Melamine	 67kg	<b>Z11/M</b> 1.014	<b>Z11/W</b> 2.793	<b>Z11/C</b> 3.954	133
	800x460mm H2000mm Fixed shelf Metalic	 67kg	<b>Z12/M</b> 1.154	<b>Z12/W</b> 2.933	<b>Z12/C</b> 3.802	133	
	<b>Low Doors (*)</b>						
	Top included. Shelves not included. With handles and lock.	800x460mm H1580mm Fixed shelf Melamine	 45kg	<b>Z06/M</b> 872	<b>Z06/W</b> 1.886	<b>Z06/C</b> 3.362	69
	800x460mm H2000mm Fixed shelf Melamine	 56kg	<b>Z10/M</b> 989	<b>Z10/W</b> 2.003	<b>Z10/C</b> 3.761	69	

(\*) CABINET OPTION WITH OR WITHOUT LOCK. IF NOT SPECIFIED IN THE ORDER, IT WILL BE SENT WITH A LOCK.

# Zubi

## DRAWING

## SPECIFICATION

## MEASURES mm

## REF.

## €uros

## REF.

## €uros

## €uros

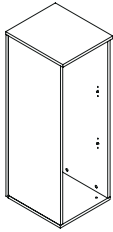

### Diaphanous

Top included.  
Shelves not included.

400x460mm  
H750mm



	Melamine 19mm		Melamine body 19mm + wooden top 19mm		Wood 19mm	
<b>Z13/M</b>	382		<b>Z13/W</b>	626	<b>Z13/C</b>	1.111
<b>Z15/M</b>	476		<b>Z15/W</b>	725	<b>Z15/C</b>	1.459
<b>Z17/M</b>	514		<b>Z17/W</b>	760	<b>Z17/C</b>	1.807
<b>Z21/M</b>	557		<b>Z21/W</b>	801	<b>Z21/C</b>	2.155

400x460mm  
H1165mm



400x460mm  
H1580mm



400x460mm  
H2000mm



### With Doors (\*)

Top included.  
Shelves not included.  
With handles and lock.

400x460mm  
H750mm



400x460mm  
H1165mm



400x460mm  
H1580mm



400x460mm  
H2000mm

Fixed shelf Melamine



400x460mm  
H2000mm

Fixed shelf Metalic



	Melamine 19mm		Melamine body 19mm + wooden doors and top 19mm		Wood 19mm		Price increase for "Silent system" hinges
<b>Z14/M</b>	443		<b>Z14/W</b>	1.022	<b>Z14/C</b>	1.632	39
<b>Z16/M</b>	537		<b>Z16/W</b>	1.243	<b>Z16/C</b>	1.980	56
<b>Z20/M</b>	567		<b>Z20/W</b>	1.418	<b>Z20/C</b>	2.328	56
<b>Z23/M</b>	676		<b>Z23/W</b>	1.639	<b>Z23/C</b>	2.676	69
<b>Z24/M</b>	791		<b>Z24/W</b>	1.754	<b>Z24/C</b>	2.791	69

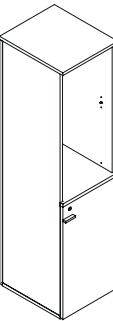

### Low Doors (\*)

Top included.  
Shelves not included.  
With handles and lock.

400x460mm  
H1580mm

Fixed shelf Melamine



800x460mm  
H2000mm

Fixed shelf Melamine



	Melamine 19mm		Melamine body 19mm + wooden doors and top 19mm		Wood 19mm		Price increase for "Silent system" hinges
<b>Z18/M</b>	750		<b>Z18/W</b>	1.332	<b>Z18/C</b>	2.328	39
<b>Z22/M</b>	819		<b>Z22/W</b>	1.401	<b>Z22/C</b>	2.539	39

(\*) CABINET OPTION WITH OR WITHOUT LOCK. IF NOT SPECIFIED IN THE ORDER, IT WILL BE SENT WITH A LOCK.

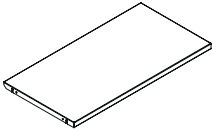
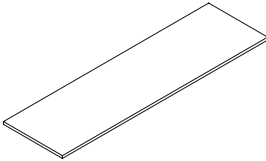
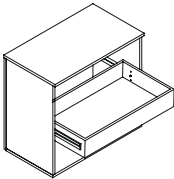
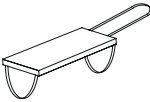
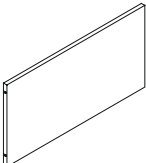

## ACCESSORIES

DRAWING	SPECIFICATION	REF.	€uros	REF.	€uros	REF.	€uros
	<b>SHELF</b> Armario 800mm			Melamine 19mm		Wood 19mm	
		<b>Z30/M</b>	74	<b>Z30/W</b>	384	<b>Z31/M</b>	161
	<b>SHELF</b> Armario 400mm	<b>Z32/M</b>	56	<b>Z32/W</b>	257	<b>Z33/M</b>	112
	<b>TOP HALF MODULE</b> 400mm			Melamine 19mm		Wood 19mm	
		<b>Z34/M</b>	59	<b>Z34/W</b>	288		
	<b>TOP ONE MODULE</b> 800mm	<b>Z35/M</b>	79	<b>Z35/W</b>	458		
	<b>TOPS ONE MODULE AND HALF</b> Half module right 1200mm	<b>Z36/M</b>	130	<b>Z36/W</b>	742		
	<b>TOPS ONE MODULE AND HALF</b> Half module left 1200mm	<b>Z37/M</b>	130	<b>Z37/W</b>	742		
	<b>TOPS TWO MODULES</b> 1600mm	<b>Z38/M</b>	148	<b>Z38/W</b>	913		
	<b>TOPS TWO MODULES AND HALF</b> Half module right 2000mm	<b>Z39/M</b>	199	<b>Z39/W</b>	1.197		
	<b>TOPS TWO MODULES AND HALF</b> Half module left 2000mm	<b>Z40/M</b>	199	<b>Z40/W</b>	1.197		
	<b>TOPS TWO MODULES AND HALF</b> Half module center 2000mm	<b>Z46/M</b>	199	<b>Z46/W</b>	1.197		
	<b>TOPS THREE MODULES</b> 2400mm	<b>Z41/M</b>	219	<b>Z41/W</b>	1.368		
	<b>PULL OUT DRAWER</b> Only for the first two levels	<b>Z42/M</b>	455				
	<b>DOUBLE PULL OUT DRAWER</b> Counter weight included	<b>Z45/M</b>	1.187				
	<b>ADJUSTABLE HANGER</b> 350x25xH85mm	<b>Z43/M</b>	56				
	<b>COUNTER WEIGHT FOR CABINET WITH DRAWER</b> 725x525xH8mm Mandatory for the second level	<b>Z44/M</b>	336				



LIBRARY OF MATERIALS

FABRICS  
PLASTICS  
PAINT ON METAL  
TABLE TOPS  
WOOD SHELLS  
WOODEN BASES

**AKABA**

---

<b>SUGGESTED COMBINATIONS</b>	p. 04
<b>FABRICS</b>	p. 14
<b>PLASTICS</b>	p. 34
<b>PAINT ON METAL</b>	p. 38
<b>TABLE TOPS</b>	p. 42
<b>WOOD SHELLS</b>	p. 50
<b>WOODEN BASES</b>	p. 54

---

C

SUGGESTED  
COMBINATIONS



P-893 Mocha (\*RAL 7006)

C-3010 Latte

M-814 Oak Aurora

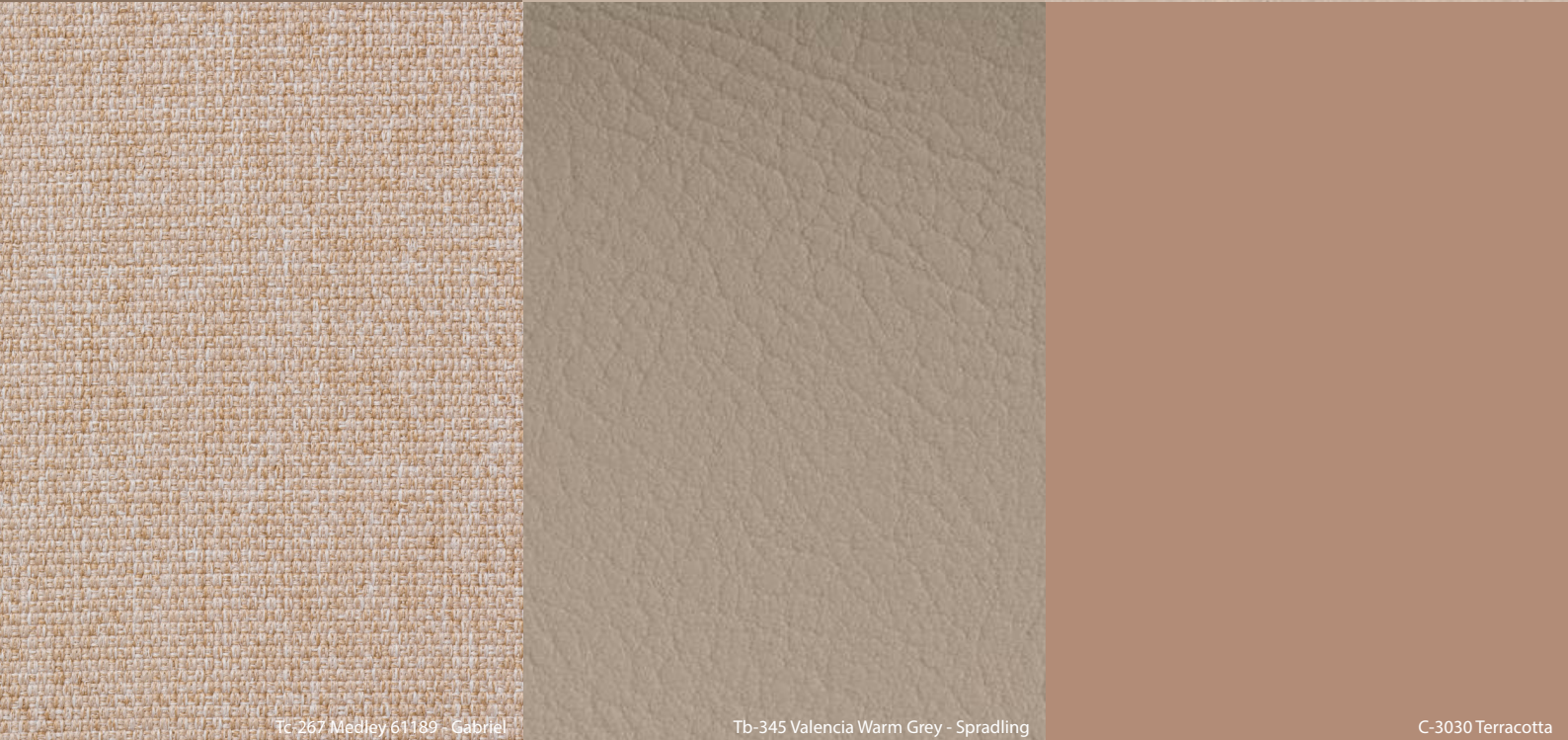

Tc-267 Medlay 61189 - Gabriel

Tb-345 Valencia Warm Grey - Spradling

C-3030 Terracotta

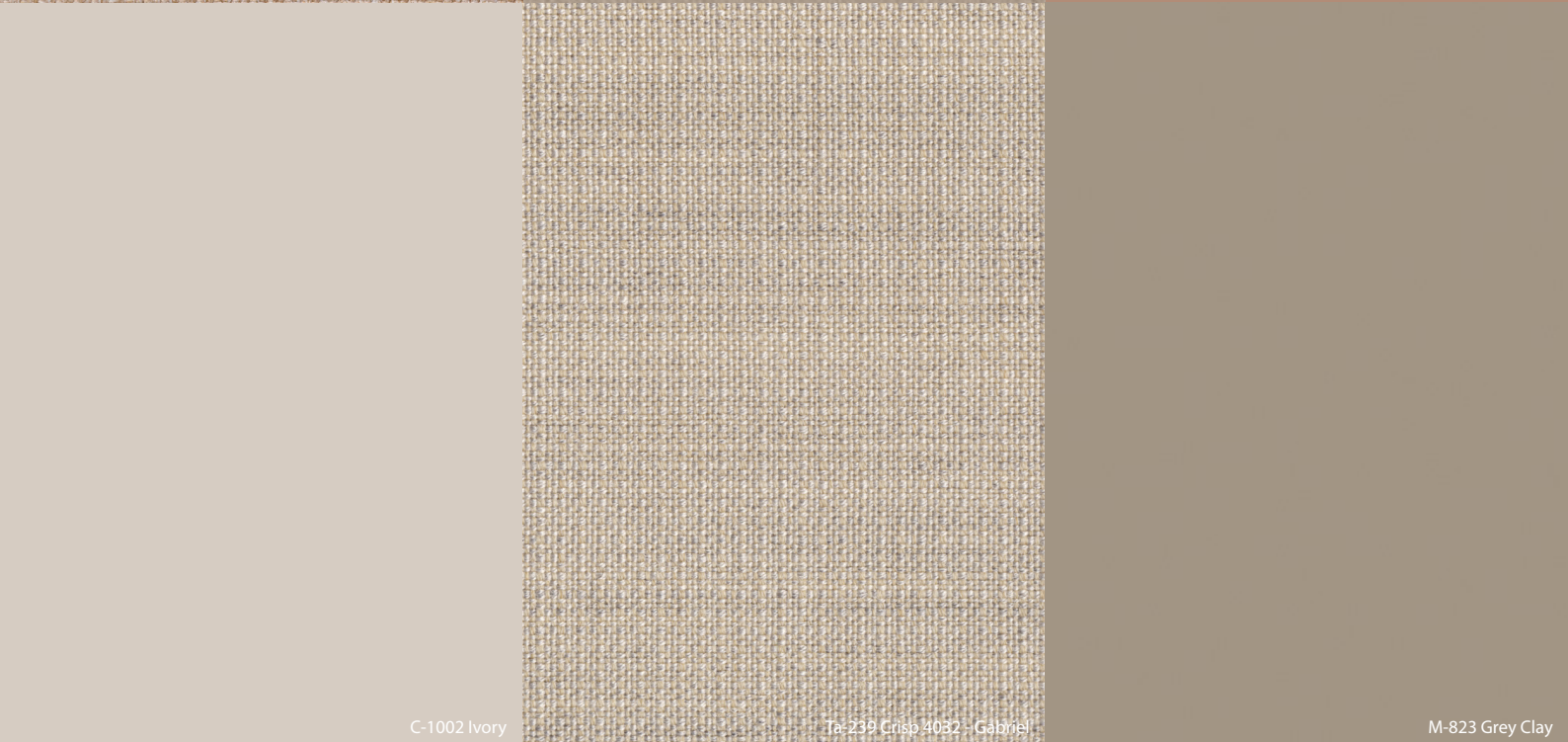

C-1002 Ivory

Ta-239 Crisp 4032 - Gabriel

M-823 Grey Clay

*Natural*  
Slightly warm shades that  
convey calm, peace and  
tranquillity.







*Industrial*

Neutral and cool shades  
that convey confidence  
and calmness.

M-816 Oak Azabache

Tc-217 Gravity Slate - Camira

C-052 Traffic Grey

Tb-349 Valencia Petrol - Spradling

Ta-227 Remix3 143 - Kvadrat

P-240 Silver Textured (\*RAL 9006)

P-7024 Graphite Grey (\*RAL 7024)

Ta-246 Breeze Fusion Breeze 40003 - Gabriel

Tb-253 Valencia Pure White - Spradling







**F**

FABRICS



# FABRIC SAMPLES

Warning: the colors and/or shades of the finishes displayed on screen are to be taken as reference, as they might vary from the physical samples. In case of doubt, request our physical samples before placing an order.

## *Blazer by Camira*

### GROUP A



Ta-154 - SILCOATES

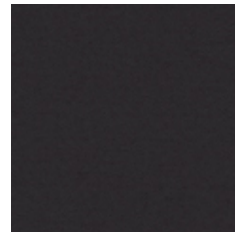

Ta-152 - NAPIER

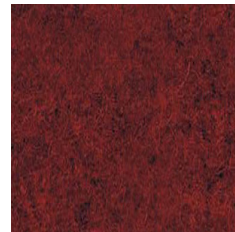

Ta-164 - EDGE HILL



Ta-157 - DUNHURST



Ta-161 - CAMPHILL



Ta-159 - ST. ANDREWS



Ta-155 - SILVERDALE

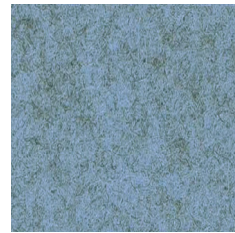

Ta-162 - PLYMOUTH

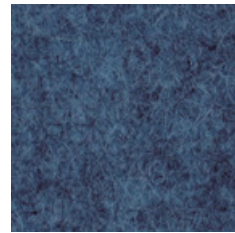

Ta-163 - NEWCASTLE

## *Crisp by Gabriel*

### GROUP A

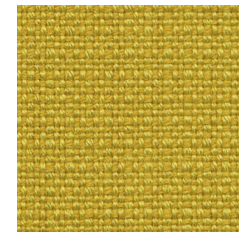

Ta-231 - CRISP 4211

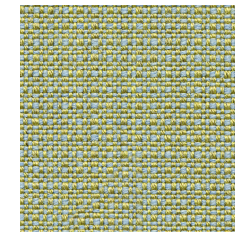

Ta-232 - CRISP 4201

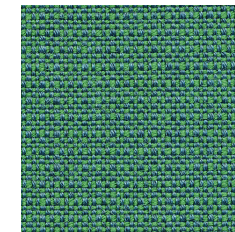

Ta-233 - CRISP 4605

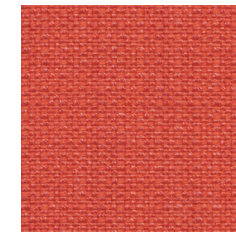

Ta-235 - CRISP 4431

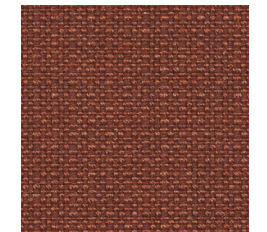

Ta-234 - CRISP 4301



Ta-237 - CRISP 4711

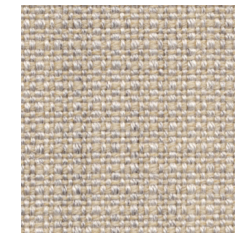

Ta-239 - CRISP 4032



Ta-238 - CRISP 4115

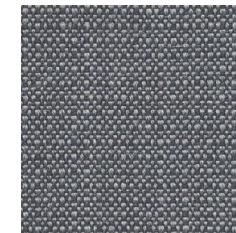

Ta-230 - CRISP 4022

## *Breeze Fusion by Gabriel*

### GROUP A

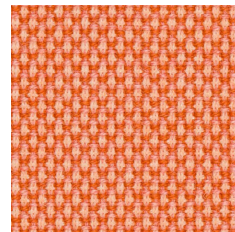

Ta-240 - BREEZE 4303



Ta-241 - BREEZE 4820

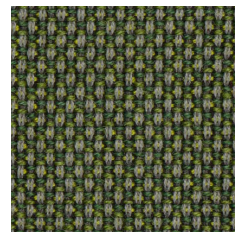

Ta-243 - BREEZE 4932

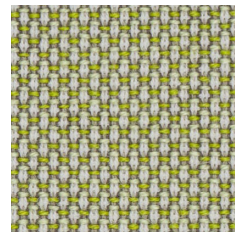

Ta-242 - BREEZE 4804

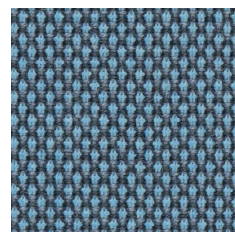

Ta-244 - BREEZE 4602



Ta-245 - BREEZE 4890

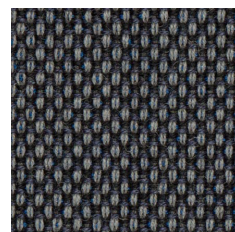

Ta-247 - BREEZE 4936

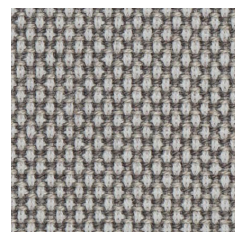

Ta-246 - BREEZE 4003

## *Focus & Focus Royal by Gabriel*

### GROUP A



Ta-305 - FOCUS 60211



Ta-306 - FOCUS 64045



Ta-307 - FOCUS 61244



Ta-308 - FOCUS 68250

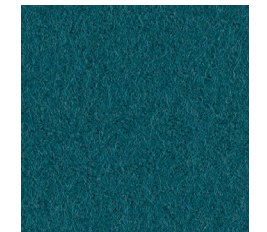

Ta-309 - FOCUS 66010

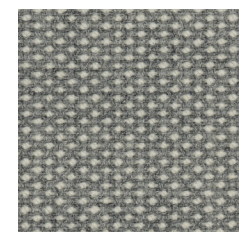

Ta-310 - FOCUS ROYAL 60509

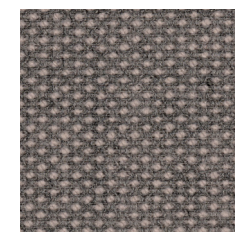

Ta-311 - FOCUS ROYAL 64545

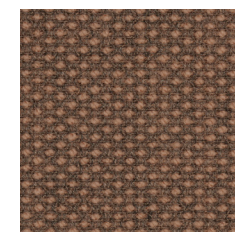

Ta-312 - FOCUS ROYAL 61535

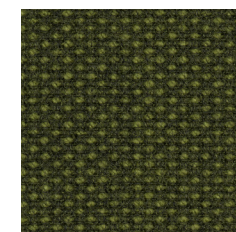

Ta-313 - FOCUS ROYAL 68535

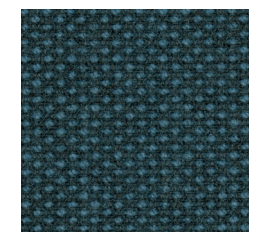

Ta-314 - FOCUS ROYAL 66520



*Grain by Gabriel*

GROUP A



Ta-300 - GRAIN 61252

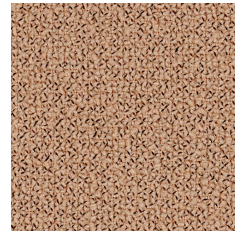

Ta-301 - GRAIN 64249

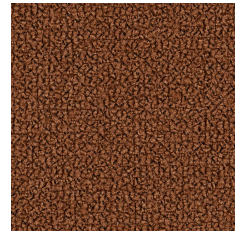

Ta-302 - GRAIN 61256

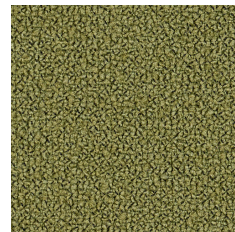

Ta-303 - GRAIN 68243

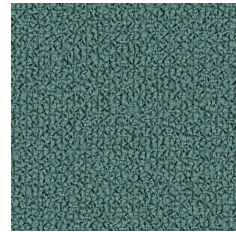

Ta-304 - GRAIN 66236

*Ascot by Elastron*

GROUP B



Tb-500 - PEARL 02



Tb-501 - TOFFEE 04

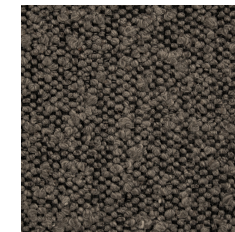

Tb-502 - MOUSE 06

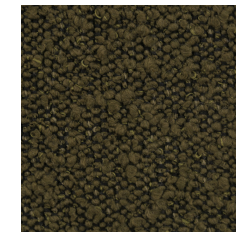

Tb-503 - OLIVE GREEN



Tb-504 - BLACK 12



Tb-505 - MOSTAZA



Tb-506 - BRICK 13

*Remix 3 by Kvadrat*

GROUP A

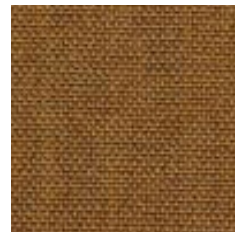

Ta-229 - REMIX3 433

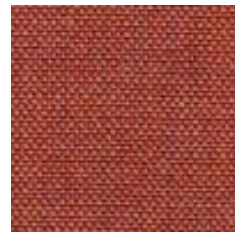

Ta-222 - REMIX3 632



Ta-221 - REMIX3 612



Ta-224 - REMIX3 223



Ta-225 - REMIX3 233

*Cyber by Gabriel*

GROUP B

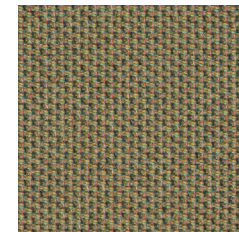

Tb-400 - CYBER 1701

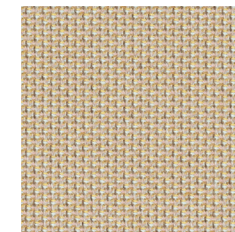

Tb-401 - CYBER 1102

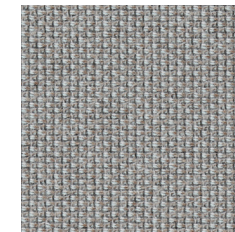

Tb-402 - CYBER 1901

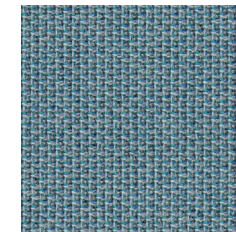

Tb-403 - CYBER 2401

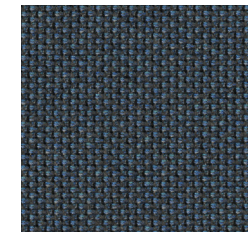

Tb-404 - CYBER 1601



Ta-223 - REMIX3 733



Ta-227 - REMIX3 143

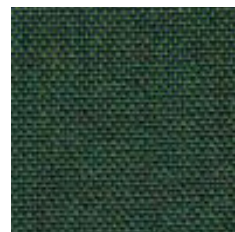

Ta-226 - REMIX3 982



Ta-228 - REMIX3 183

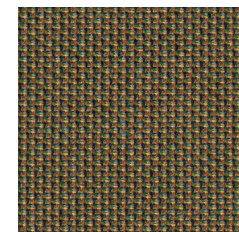

Tb-405 - CYBER 3001

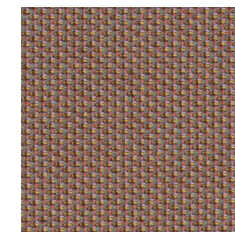

Tb-406 - CYBER 1201

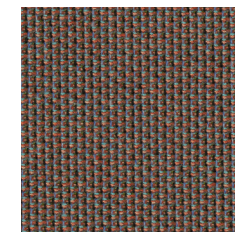

Tb-408 - CYBER 1401

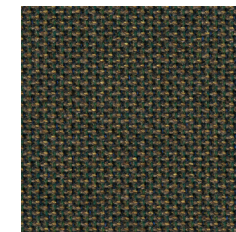

Tb-407 - CYBER 1302

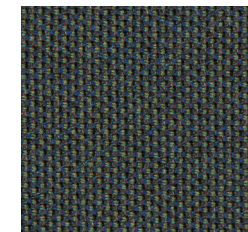

Tb-409 - CYBER 1803



*Go Uni by Gabriel*

GROUP B

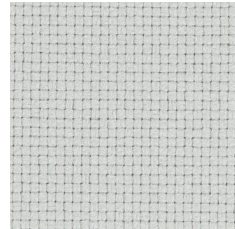

Tb-350 - UNI 60093

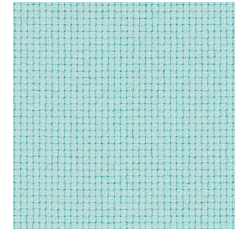

Tb-353 - UNI 68168

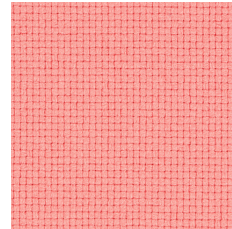

Tb-354 - UNI 64183

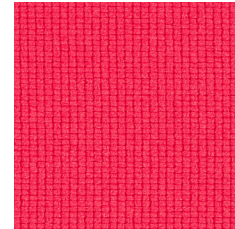

Tb-357 - UNI 64174

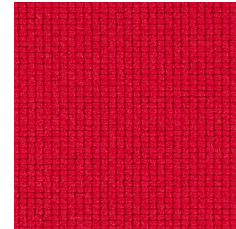

Tb-360 - UNI 64175

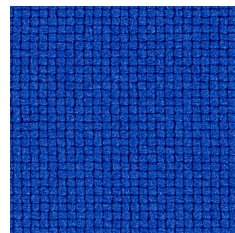

Tb-359 - UNI 66136

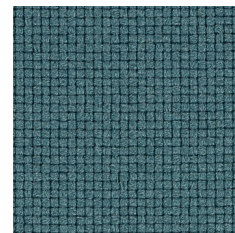

Tb-356 - UNI 67071

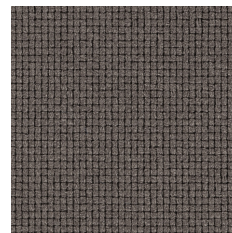

Tb-355 - UNI 61140



Tb-358 - UNI 60999

*Step Melange by Gabriel*

GROUP B

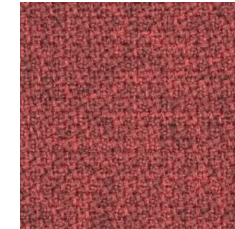

Tb-307 - 64178



Tb-308 - 61104

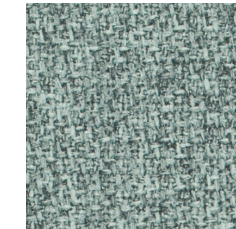

Tb-309 - 68118



Tb-314 - 67004

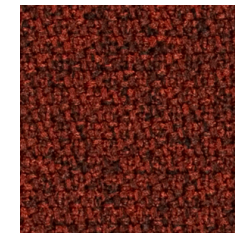

Tb-315 - 63075



Tb-305 - 61103

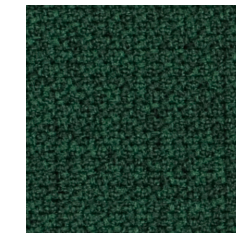

Tb-316 - 68161



Tb-317 - 66019

*Main Line Flax by Camira*

GROUP B

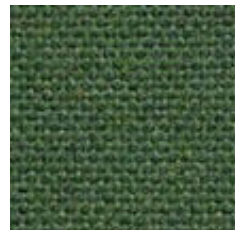

Tb-293 - FARRINGTON



Tb-283 - BAYSWATER



Tb-287 - ARCHWAY



Tb-290 - UPMINSTER



Tb-292 - PARSONS



Tb-281 - WATERLOO

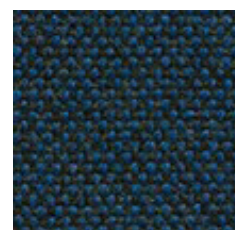

Tb-282 - VICTORIA

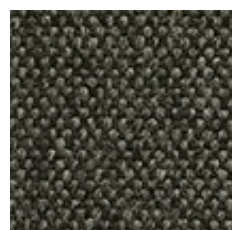

Tb-288 - TEMPLE



Tb-284 - GOLDHAWK

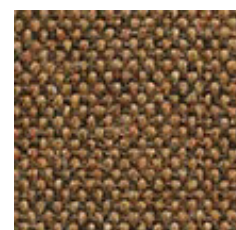

Tb-286 - STOCKWELL

*Valencia by Spradling*

GROUP B



Tb-348 - CHESTNUT

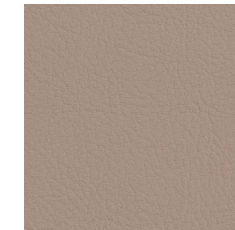

Tb-345 - WARM GREY

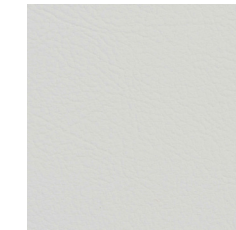

Tb-253 - PURE WHITE



Tb-347 - CASHMERE

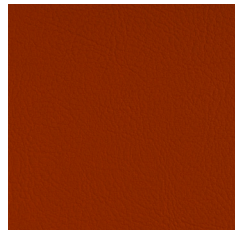

Tb-246 - KIRSCH

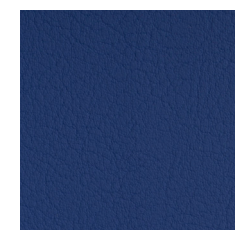

Tb-244 - LAVENDEL

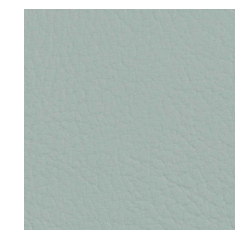

Tb-346 - SKYLIGHT

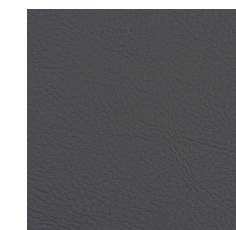

Tb-349 - PETROL



Tb-248 - GRAPHITE

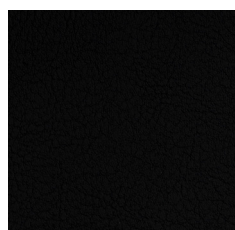

Tb-252 - SCHWARZ



*Citadel by Camira*

GROUP C



Tc-188 - STILLWATER



Tc-189 - RESISTANCE

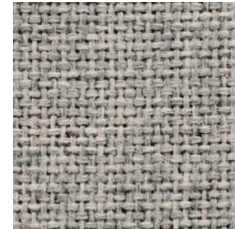

Tc-191 - REDOUBT

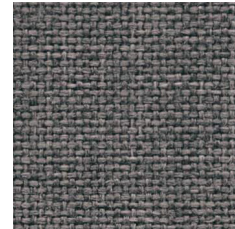

Tc-190 - CONFINE

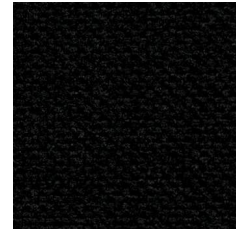

Tc-182 - CRAVEN

*Gravity by Camira*

GROUP C

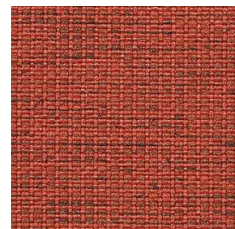

Tc-212 - TIGERLILLY

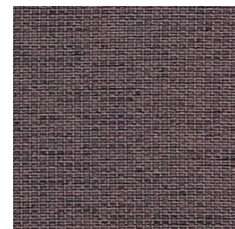

Tc-209 - NUTMEG

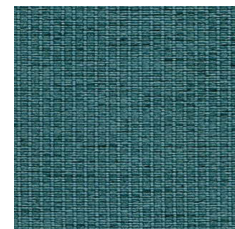

Tc-208 - LAKE

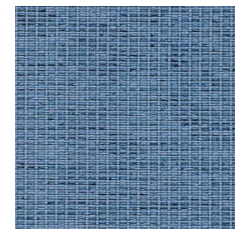

Tc-215 - FROZEN

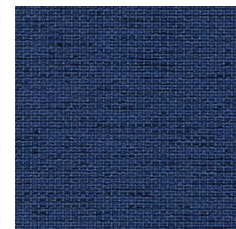

Tc-219 - BROOK

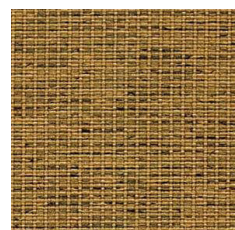

Tc-214 - MUSTARD



Tc-213 - ALMOND

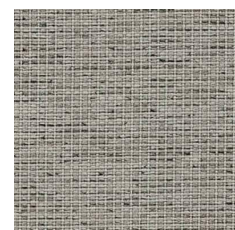

Tc-210 - DOVE



Tc-217 - SLATE



Tc-218 - BLACK

*Medley by Gabriel*

GROUP C



Tc-268 - 61003

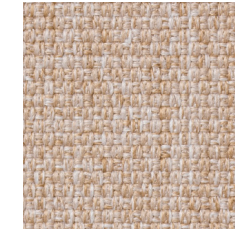

Tc-267 - 61189

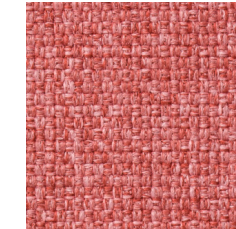

Tc-261 - 63064



Tc-260 - 63063



Tc-262 - 63016

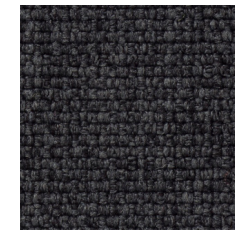

Tc-270 - 60999



Tc-266 - 60167

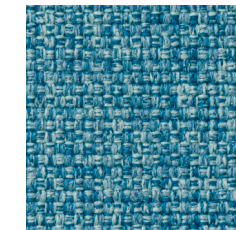

Tc-264 - 67006

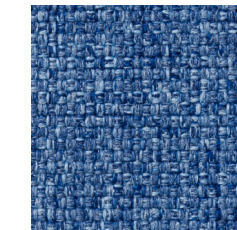

Tc-265 - 66144

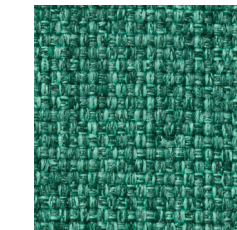

Tc-263 - 67054

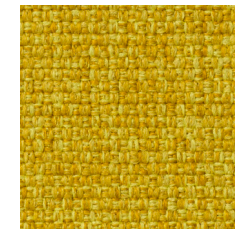

Tc-269 - 62002

*Tonal by Gabriel*

GROUP C



Tc-304 - TONAL 60999

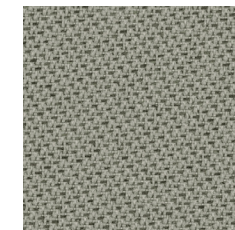

Tc-305 - TONAL 60123

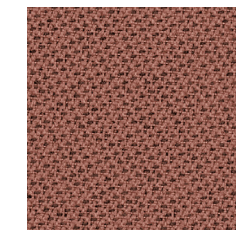

Tc-306 - TONAL 64210

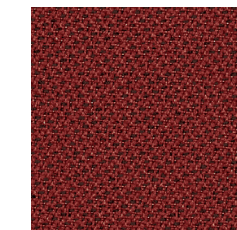

Tc-307 - TONAL 64209

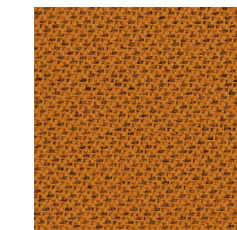

Tc-308 - TONAL 63098

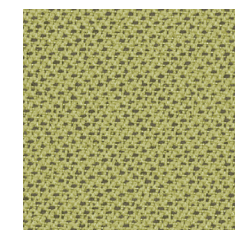

Tc-300 - TONAL 62092

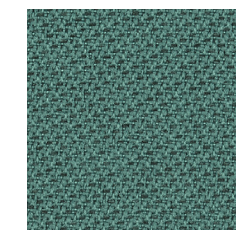

Tc-301 - TONAL 67090

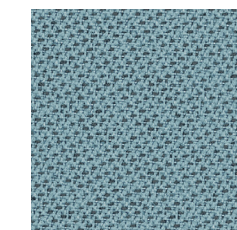

Tc-302 - TONAL 66185



Tc-303 - TONAL 61180



*Basic F.R. by Exit Fabrics*

GROUP D

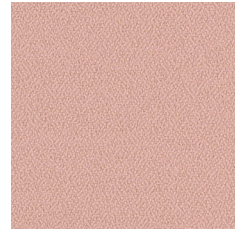

Td-104 - A315

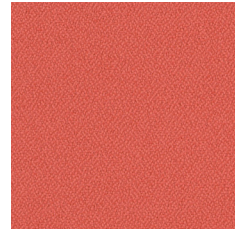

Td-101 - A462

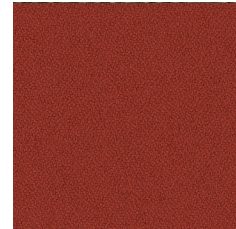

Td-100 - A027

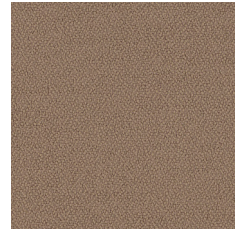

Td-110 - G132

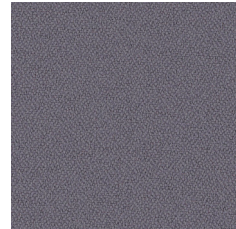

Td-105 - A108

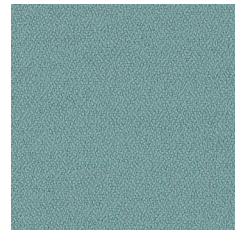

Td-109 - A301

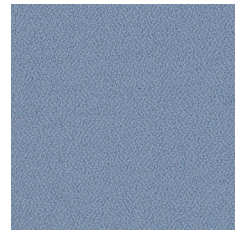

Td-103 - A095

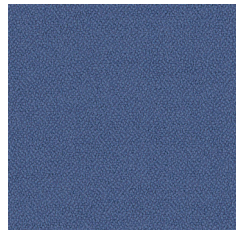

Td-107 - A004



Td-102 - A026

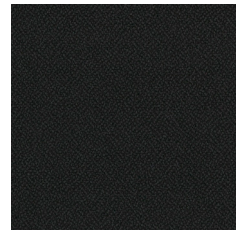

Td-106 - A009



Td-108 - A755

*Leather by Antic Cuir*

LEATHER



T-149 - OFF-WHITE



T-102 - BEIGE



T-139 - LIGHT BROWN



T-115 - DARK BROWN

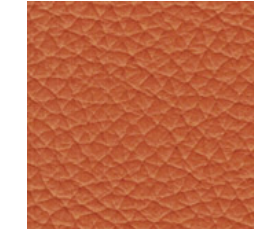

T-116 - CAMEL BROWN

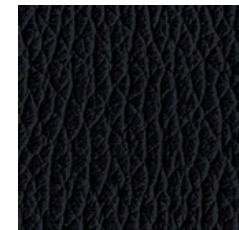

T-401 - BLACK

*Hide by Inter Leather*

HIDE

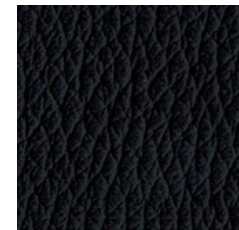

T-301 - BLACK

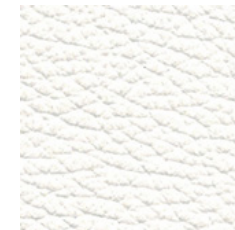

T-307 - WHITE

# UPHOLSTERY MATRIX BY COLLECTION

KEY

- Unavailable
- Available
- Available in some versions (see price list)

	ADOS	AIA	BRANKA	GORKA	HANNA	HODEI	KABI	KABI ARMCHAIR	KABI KIDS	KABI STOOL	KLASIK	LUR	MUGA & MUGA-2	OSTOA	TOPA	XOKO
GROUP A - BLAZER	•	•	•	•	•	•	•	•	-	•	•	•	•	•	•	•
GROUP A - BREEZE FUSION	•	•	•	•	•	•	•	•	-	•	•	•	•	•	•	•
GROUP A - CRISP	•	•	•	•	•	•	•	•	-	•	•	•	•	•	•	•
GROUP A - FOCUS & FOCUS ROYAL	•	•	•	•	•	•	•	•	-	•	•	•	•	•	•	•
GROUP A - GRAIN	•	•	•	•	•	•	•	•	-	•	•	•	•	•	•	•
GROUP A - REMIX 3	•	•	•	•	•	•	•	•	-	•	•	•	•	•	•	•
GROUP B - ASCOT	•	•	•	•	•	•	•	•	-	•	•	•	•	•	•	•
GROUP B - CYBER	•	•	•	•	•	•	•	•	-	•	•	•	•	•	•	•
GROUP B - GO UNI	•	•	•	•	•	•	•	•	-	•	•	•	•	•	•	•
GROUP B - MAIN LINE FLAX	•	•	•	•	•	•	•	•	-	•	•	•	•	•	•	•
GROUP B - STEP MELANGE	•	•	•	•	•	•	•	•	-	•	•	•	•	•	•	•
GROUP B - VALENCIA	•	•	•	•	•	•	•	•	-	•	•	•	•	•	•	•
GROUP C - CITADEL	•	•	•	•	•	•	•	•	-	•	•	•	•	•	•	•
GROUP C - GRAVITY	•	•	•	•	•	•	•	•	-	•	•	•	•	•	•	•
GROUP C - MEDLEY	•	•	•	•	•	•	•	•	-	•	•	•	•	•	•	•
GROUP C - TONAL	•	•	•	•	•	•	•	•	-	•	•	•	•	•	•	•
GROUP D - BASIC F.R.	•	•	•	•	•	•	•	•	-	•	•	•	•	•	•	•
LEATHER	•	•	-	◦	•	•	•	•	-	•	•	•	•	-	•	•
HIDE	-	-	•	•	-	-	-	-	-	-	-	-	-	-	-	-



## TECHNICAL SPECIFICATIONS BY FABRIC

### *Blazer by Camira*

GROUP A

Composition	100% Pure Virgin Wool. Non-metallic dyes.
Weight	460 gr/m <sup>2</sup> ±5%
Abrasion resistance	50.000cl Martindale
Flammability	EN 1021 - 1&2 (cigarettes and matches) • BS 7176 Low risk • NF D 60-013 • ÖNORM B 3825 and A 3800-1 (58 kg/m <sup>3</sup> CMHR foam) • UNI 9175 Class 1 IM • BS 476 Part 7 Class 1 (Adhered) • EN 13501-1 Adhered Class D, s1, d0 • IMO FTP Code (Part 8) • Furniture and Furnishings (Fire Safety) Regulations 1988 (UK National Cigarettes and Matches) • BS 5852 Ignition source 5 when dealing with FR • BS 7176 Medium hazard when dealing with FR • BS 476 Part 6 Class 0 when dealing with FR (adhered) • EN 13501-1 Adhered Class B, s1, d0 when treated with FR • EN 13501-1 Unadhered Class D, s2, d0 when treated with FR • BS 5867-2 Curtains and drapes type B with FR treatment.
Maintenance	Vacuum regularly. Clean with a damp cloth with soap and water or use a patented upholstery shampoo. For deeper cleaning, use steam or professional dry cleaning. www.camirafabrics.com

### *Breeze Fusion by Gabriel*

GROUP A

Composition	88% New Zealand wool, 12% Polyamide.
Weight	590 gr/ml
Abrasion resistance	100.000cl Martindale
Flammability	BS 5852 Part 1 0.1 Cigarettes and matches, Furniture and Equipment Regulations 1988 • BS EN 1021 1 and 2 Cigarettes and matches • CA TB 117-2013 • ASTM E 84 Class 2 • Class One UNI 9175 Class 1 I EMME • AM 18 - NF D 60-013-(for fabric only) • It will also pass other flammability standards. Flame retardant performance depends on the foam used. It does not contain flame retardant chemicals.
Maintenance	Dry cleaning. www.gabriel.dk

### *Crisp by Gabriel*

GROUP A

Composition	93% New Zealand wool, 7% Polyamide.
Weight	460 gr/ml
Abrasion resistance	200.000cl Martindale
Flammability	BS 5852 Part 1 0.1 Cigarette & Match, The Furniture and Furnishing Regulations 1988 • BS 476 Part 7 class 2 • BS EN 1021 1&2 Cigarette and Match • Class Uno UNI 9175 Class 1 I EMME • CA TB 117-2013 • IMO MSC 307(88) Annex 1 part 8 • MED Certificate IMO • IMO MSC 307(88) Annex 1 part 8 UK • MED Certificate IMO UK • ÖNORM A3800-B2-B3825-Q1 UK • Will also pass other flammability standards. Flame retardant performance is dependent upon the foam used. Contains no flame retardant chemicals.
Maintenance	Dry cleaning. www.gabriel.dk

### *Focus by Gabriel*

GROUP A

Composition	100% New Zealand wool.
Weight	660 gr/ml
Abrasion resistance	100.000cl Martindale
Flammability	BS EN 1021 1 and 2 Cigarettes and matches • BS 5852 Part 1 0.1 Cigarettes and matches, Furniture and Equipment Regulations 1988 • CA TB 117-2013 • ASTM E 84 Class 2 • Class One UNI 9175 Class 1 I EMME • AM 18 - NF D 60-013-(for fabric only) - ÖNORM A3800-B1-B3825-Q1 United Kingdom • It will also pass other flammability standards. Flame retardant performance depends on the foam used. It does not contain flame retardant chemicals.
Maintenance	Dry cleaning. www.gabriel.dk

### *Focus Royal by Gabriel*

GROUP A

Composition	100% New Zealand wool.
Weight	630 gr/ml
Abrasion resistance	100.000cl Martindale
Flammability	BS EN 1021 1 and 2 Cigarettes and matches • BS 5852 Part 1 0.1 Cigarettes and matches, Furniture and Equipment Regulations 1988 • Class One UNI 9175 Class 1 I EMME • CA TB 117-2013 • ASTM E 84 Class 2 • It will also pass other flammability standards. Flame retardant performance depends on the foam used. It does not contain flame retardant chemicals.
Maintenance	Dry cleaning. www.gabriel.dk

### *Grain by Gabriel*

GROUP A

Composition	80%-92% post-consumer recycled polyester, 8%-20% polyester.
Weight	615 gr/ml
Abrasion resistance	100.000cl Martindale
Flammability	BS EN 1021 1 and 2 Cigarettes and matches • BS EN 1021-1 Cigarette • CA TB 117-2013 • Contains no flame retardant chemicals. It will also pass other flammability standards. Flame retardant performance depends on the foam used.
Maintenance	Dry cleaning. www.gabriel.dk

## Remix 3 by Kvadrat

GROUP A

Composition	90% combed Virgin Wool, 10% Nylon.
Weight	420 gr/ml
Abrasion resistance	100.000cl Martindale
Flammability	BS 5852 Crib 5 with treatment • BS 5852 part 1 • IMO FTP 2010 Code Part 7 with treatment • IMO FTP 2010 Code Part 8 • NF D 60 013 - NFPA 260 • SN 198 898 5.3 with treatment • UNI 9175 1IM • US Cal. Bull. 117-2013 • EN 1021-1/2 • AS/NZS 3837 class 2 • ÖNORM B1/Q1 • ASTM E84 Class A Unbound • ASTM E84 Class A Adhered • EN 13501 B-s2, d0 with treatment - GB 50222 B1 with treatment (Chinese) • AS/NZS 1530.3
Maintenance	Professional dry cleaning. Iron at low temperature (max 150 °C). www.kvadrat.org

## Ascot by Elastron

GROUP B

Composition	100% Polyester.
Weight	970 gr/ml
Abrasion resistance	80.000cl Martindale
Flammability	BS 5852 Part 1 (cigarettes) - EN 1021-1 (cigarettes) - CA Tech. Bull. 117:2013 / NFPA 260 (cigarettes).
Maintenance	Clean with a damp cloth. www.elastrongroup.com

## Cyber by Gabriel

GROUP B

Composition	100% post-consumer recycled Polyester.
Weight	570 gr/ml
Abrasion resistance	120.000cl Martindale
Flammability	BS EN 1021 1 and 2 Cigarettes and matches • CATB 117-2013 • It will also pass other flammability standards. Flame retardant performance depends on the foam used. It does not contain flame retardant chemicals
Maintenance	Dry cleaning. www.gabriel.dk

## Go Uni by Gabriel

GROUP B

Composition	100% Trevira.
Weight	435 gr/ml
Abrasion resistance	100.000cl Martindale
Flammability	BS 7176 Medium hazard • BS 5852 Crib 5 • BS EN 1021-1 Cigarette • BS EN 1021 1 and 2 Cigarettes and matches • DIN 4102-B1 • PFN 92-503/504/505 M1 • ÖNORM A3800-B1-B3825-Q1 UK • Class 1 UNI 9175 Class 1 I EMME • FAR/JAR 25. 853 (a) (i) (ii) • CATB 117-2013 • DIN EN 13501-1 B-s1,d0 • AM 18 - NF D 60-013-(for fabric only) • It will also pass other flammability standards. Flame retardant performance depends on the foam used
Maintenance	Dry cleaning. www.gabriel.dk

## Main Line Flax by Camira

GROUP B

Composition	75% Virgin Wool, 25% Flax.
Weight	437 gr/m <sup>2</sup> ±5%
Abrasion resistance	50.000cl Martindale
Flammability	EN 1021 - 1&2 (cigarette & match) • BS 7176 Low Hazard • BS 7176 Medium Hazard • ÖNORM B 3825 & A 3800-1 (58kg/m <sup>3</sup> CMHR Foam) • UNI 9175 Classe 1 IM • BS 5867-2: Type B Curtains & Drapes • BS 5852 Ignition Source 5 • NF D 60-013 • The Furniture and Furnishing (Fire Safety) Regulations 1988 (UK domestic cigarette and match) • IMO FTP Code (Part 8) • BS 476 Part 7 Class 1 (Adhered) • EN 13501-1 Adhered Class B, s1 ,d0
Maintenance	Vacuum regularly. Wipe with a damp cloth using a proprietary upholstery shampoo/ soap. For deeper cleaning use steam or professionally dry clean. www.camirafabrics.com

## Step Melange by Gabriel

GROUP B

Composition	100% Trevira.
Weight	470 gr/ml
Abrasion resistance	100.000cl Martindale
Flammability	DIN 4102-B1 • PFN 92-503/504/505 M1 • BS EN 1021 1 & 2 Cigarettes and matches • BS EN 1021-1 Cigarette • BS 5852 Crib 5 • ÖNORM A3800-B1-B3825-Q1 UK • FAR/JAR 25. 853 (a) (i) (ii) • AM 18 - NF D 60-013-(only for fabric) • CATB 117-2013 • Class 1 UNI 9175 Class 1 I EMME • DIN EN 13501-1 B-s1,d0 • IMO MSC 307(88) Annex 1 part 8 • Certificate MED IMO • IMO MSC 307(88) Annex 1 part 8 UK • Certificate MED IMO UK • CAN/ULC-S102.2 • CAN/ULC-S109 • It will also pass other flammability standards. Flame retardant performance depends on the foam used
Maintenance	Dry cleaning. www.gabriel.dk

## Valencia by Spradling

GROUP B

Composition	100% Vinyl coating, 100% Hi-Loft 2TM Polyester support.
Weight	650 gr/m <sup>2</sup>
Abrasion resistance	300.000cl Martindale
Flammability	AT: ÖNORM A 3800 Part 1, smoke class Q1 - low smoke • AT: ÖNORM B 3825, GROUP 1 - Hardly combustible behavior • DE: DIN 4102 B2 • ES: UNE 23.727-90 1R/M.2 • EU: ECE Regulation No. 118:03 (R118.02 Annexes 6, 7 and 8) • EU: EN 1021, Part 1 and 2 • EU: EN 71-2:2006+A1:2007 - Toy safety - Part 2: Flammability • FR: NF P 92-503/M2 • IMO FTP 2010 Code MSC.307 (88) Part 8 3.1 and 3.2 • IT: UNI 9175 (1987) / UNI 9175/FA1 (1994) Class 1.1M (UNO I EMME) • (MED) Marine Equipment Directive (in its current version) 2 • USA: CAL TB 117-2013, Section E • USA: Compliance with ASTM E 84 - Class I • USA: FAR 25/853 • USA: FMVSS 302 • USA: NFPA 260 - Class 1
Maintenance	Clean with a damp cloth. www.spradling.eu

---

## *Citadel by Camira*

**GROUP C**

Composition	100% flame retardant Polypropylene.
Weight	230 gr/m <sup>2</sup> ±5%
Abrasion resistance	30.000cl Martindale
Flammability	EN 1021 - 1&2 (cigarette & match) • BS 7176 Low Hazard • DIN 4102 B1 • ÖNORM B 3825 & A 3800-1 (58kg/m <sup>3</sup> CMHR Foam) • UNI 9175 Classe 1 IM • EN 13501-1 Adhered Class B, s1, d0 • EN 13501-1 Un-adhered Class B/C, s1, d0
Maintenance	Vacuum regularly. Wipe with a damp cloth using a proprietary upholstery shampoo/soap. For deeper cleaning use bleach or alcohol. www.camirafabrics.com

---

## *Gravity by Camira*

**GROUP C**

Composition	76% Polyester, 24% Post consumer recycled Polyester.
Weight	295 gr/m <sup>2</sup> ±5%
Abrasion resistance	80.000cl Martindale
Flammability	EN 1021 - 1&2 (cigarette & match) • BS 7176 Low Hazard • EN 13501-1 Adhered Class B, s2, d0 • EN 13501-1 Un-adhered Class B, s1, d0
Maintenance	Vacuum regularly. Wipe with a damp cloth using a proprietary upholstery shampoo/soap. For deeper cleaning use steam, bleach, alcohol or professionally dry clean. www.camirafabrics.com

---

## *Medley by Gabriel*

**GROUP C**

Composition	100% Polyester.
Weight	510 gr/ml
Abrasion resistance	75.000cl Martindale
Flammability	BS EN 1021 1&2 Cigarette and Match • BS EN 1021-1 Cigarette • BS 476 Part 7 class 2 • Class Uno UNI 9174 - UNI 8457 • ÖNORM A3800-B2-B3825-Q1 UK • CA TB 117-2013 • ASTM E 84 Class 1 • Will also pass other flammability standards. Flame retardant performance is dependent upon the foam used. Contains no flame retardant chemicals.
Maintenance	Wash or dry cleaning. www.gabriel.dk

---

## *Tonal by Gabriel*

**GROUP C**

Composition	99% post-consumer recycled Polyester, 1% Polyester.
Weight	315-385 gr/ml
Abrasion resistance	100.000cl Martindale
Flammability	CA TB 117-2013 • ASTM E 84 Class 1 • BS EN 1021 1&2 Cigarette and Match • BS EN 1021-1 Cigarette • BS 476 Part 7 class 1 • DIN EN 13501-1 B-s1,d0 (glued) • Will also pass other flammability standards. Flame retardant performance is dependent upon the foam used. Contains no flame retardant chemicals.
Maintenance	Wash or dry cleaning. www.gabriel.dk

---

## *Basic F.R. by Exit Solutions*

**GROUP D**

Composition	100% Polyester.
Weight	355 -470 gr/m <sup>2</sup> ±5%
Abrasion resistance	100.000cl Martindale
Flammability	UE: EN 1021 1/2 • UK: BS 5852 0 • UK: BS 7176 Low Hazard • USA: CAL TB 117 Section 1 • USA: NFPA 260 Class 1 • Regulation n° 118 UNECE Annex 6 • IMO MSC.307 (88) Annex I Part 8
Maintenance	Vacuum regularly. In case of stains, use a damp cloth with neutral soap suitable for cleaning of upholstery products. www.exitfabrics.com

---

## *Leather by Antic Cuir*

**LATHER**

Composition	Highly versatile European cowhide with regular grain and high cutting performance. Rectified and pigmented.
Characteristics	1,1 - 1,2mm • Embossed • 5m <sup>2</sup>
Flammability	UNE EN 1021-1&2 • California Technical Bulletin 117-2013 - IMO MSC.307 (88) Annex 1 Part 8 • Approval according to R118 "European standard for coaches and buses" • All skins are REACH compliant.
Maintenance	For cleaning and maintenance recommendations visit the supplier's website. www.anticcuir.com

---

P

PLASTICS

# PLASTIC SAMPLES

Warning: the colors and/or shades of the finishes displayed on screen are to be taken as reference, as they might vary from the physical samples. In case of doubt, request our physical samples before placing an order.

## Kabi Colors



C-6028 - PINE GREEN  
(\*RAL 6028)



C-5018 - TURQUOISE BLUE  
(\*RAL 5018)



C-3040 - MINT  
(\*PANTONE 7538)

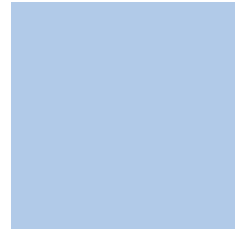

C-283 - SKY BLUE  
(\*PANTONE 283)



C-5007 - DISTANT BLUE  
(\*RAL 5007)

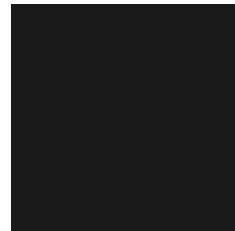

C-002 - BLACK  
(\*RAL 9004)



C-879 - GRAPHITE GREY  
(\*RAL 7024)



C-052 - TRAFFIC GREY  
(\*RAL 7042)

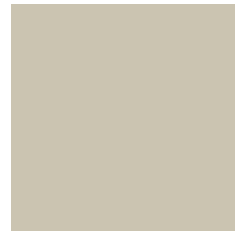

C-051 - GREY BEIGE  
(\*RAL 1019)



C-893 - MOCHA  
(\*RAL 7006)



C-952 - SPICY MUSTARD  
(\*PANTONE 952)



C-017 - ROSE  
(\*RAL 3017)



C-3030 - TERRACOTTA

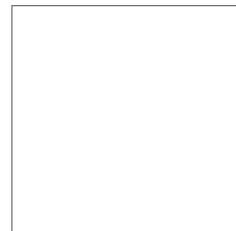

C-008 - WHITE  
(\*RAL 9010)

## Lur Colors



C-1002 - IVORY



C-3010 - LATTE



C-3030 - TERRACOTTA



C-5040 - BORDEAUX



C-879 - GRAPHITE GREY  
(\*RAL 7024)



C-2050 - OCHRE



C-3040 - MINT  
(\*PANTONE 7538)



C-7020 - NAVY BLUE



C-002 - BLACK  
(\*RAL 9004)



C-3020 LIGHT BROWN  
100% RECYCLED



C-2010 GREEN BEIGE  
100% RECYCLED

## Ados, Branka & Gorka Colors



C-008 - WHITE  
(\*RAL 9010)



C-051 - GREY BEIGE  
(\*RAL 1019)



C-052 - TRAFFIC GREY  
(\*RAL 7042)

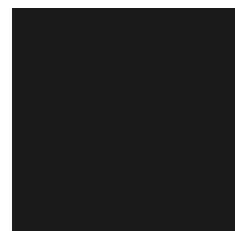

C-002 - BLACK  
(\*RAL 9004)

## Muga-2 Colors



C-008 - WHITE  
(\*RAL 9010)



C-052 - TRAFFIC GREY  
(\*RAL 7042)



C-002 - BLACK  
(\*RAL 9004)

P

PEINT ON METAL



# PAINT ON METAL SAMPLES

Warning: the colors and/or shades of the finishes displayed on screen are to be taken as reference, as they might vary from the physical samples. In case of doubt, request our physical samples before placing an order.

\*RAL/PANTONE/NCS: Approximate references.



P-283 - SKY BLUE  
(\*PANTONE 283 C)



P-5018 - TURQUOISE BLUE  
(\*RAL 5018)



P-6028 - PINE GREEN  
(\*RAL 6028)



P-252 - PALE GREEN  
(\*RAL 6021)



P-3040 - MINT



P-952 - SPICY MUSTARD  
(\*PANTONE 14-0952)



P-250 - MUSTARD  
(\*RAL 1015)



P-1017 - APRICOT  
(\*RAL 1017)



P-3012 - BEIGE RED  
(\*RAL 3012)



P-251 - ROSE  
(\*RAL 3017)

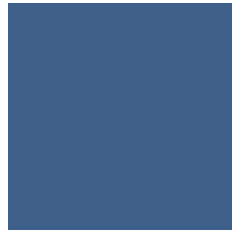

P-5007 - BRILLIANT BLUE  
(\*RAL 5007)



P-5001 - NAVY BLUE



P-7010 - WINTER GREEN  
TEXTURED (\*NCS7010 B30G)



P-7003 - MOSS GREY  
(\*RAL 7003)



P-254 - TRAFFIC GREY  
(\*RAL 7042)



P-249 - GREY BEIGE  
(\*RAL 1019)



P-1002 - IVORY



P-3010 - LATTE



P-893 - MOCHA  
(\*RAL 7006)



P-8015 - BORDEAUX

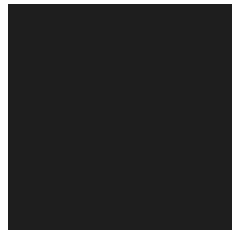

P-246 - BLACK  
(\*RAL 9017)

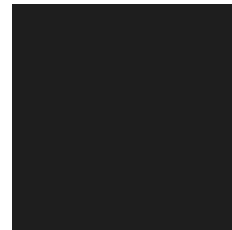

P-208 - BLACK TEXTURED  
(\*RAL 9017)



P-7024 - GRAPHITE GREY  
(\*RAL 7024)



P-247 - SILVER  
(\*RAL 9007)



P-240 - SILVER TEXTURED  
(\*RAL 9006)

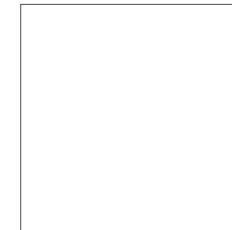

P-201 - WHITE  
(\*RAL 9010)

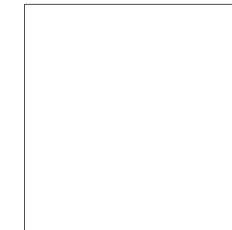

P-257 - WHITE TEXTURED  
(\*RAL 9016)

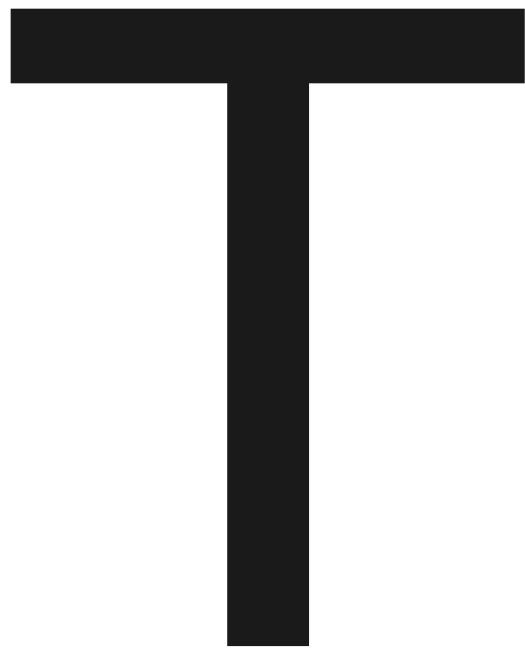
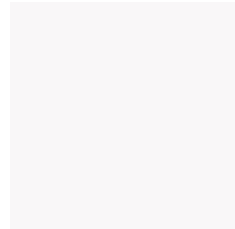

TABLE TOPS

# TABLE TOP SAMPLES

Warning: the colors and/or shades of the finishes displayed on screen are to be taken as reference, as they might vary from the physical samples. In case of doubt, request our physical samples before placing an order.

## Compact



M-626 WHITE



M-629 BLACK

## Wood



M-690 WHITE OAK

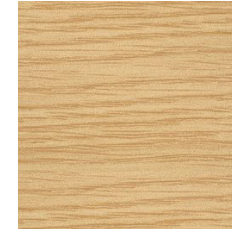

M-687 OAK

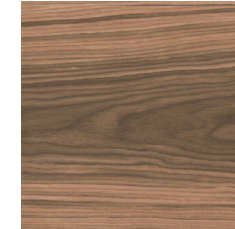

M-688 WALNUT



M-686 BLACK OAK

## Laminated + Plywood

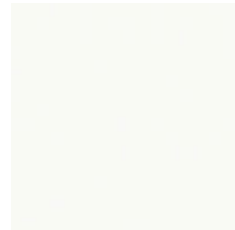

M-817E WHITE



M-821E ROSE

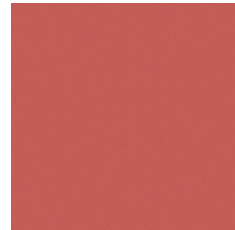

M-824E RED CLAY

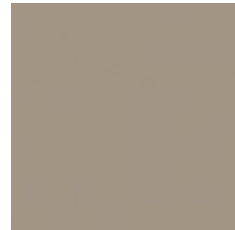

M-823E GREY CLAY



M-822E OLIVE GREEN

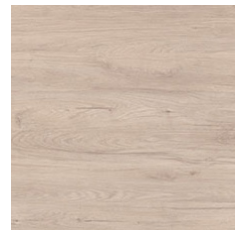

M-814E OAK AURORA



M-819E WALNUT SLOW

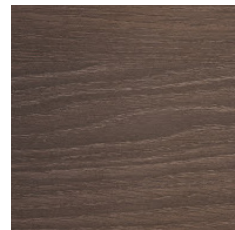

M-820E OAK SINATRA

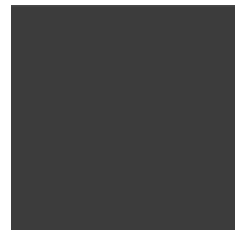

M-818E GRAPHITE



M-816E OAK AZABACHE

## Melamine

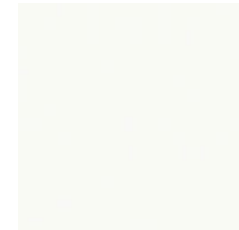

M-817 WHITE



M-821 ROSE

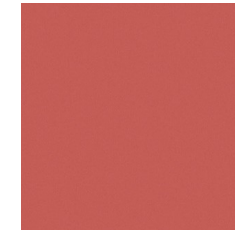

M-824 RED CLAY



M-823 GREY CLAY



M-822 OLIVE GREEN

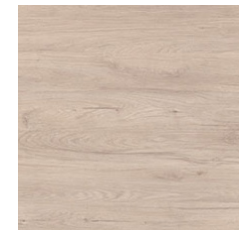

M-814 OAK AURORA



M-819 WALNUT SLOW

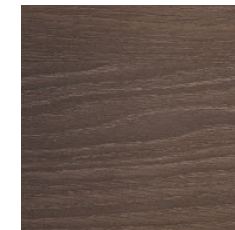

M-820 OAK SINATRA



M-818 GRAPHITE



M-816 OAK AZABACHE

## Fenix

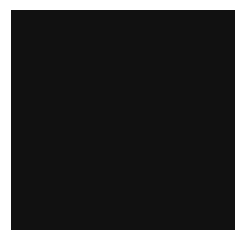

F-100 BLACK

# TABLE TOP EDGE TYPE MATRIX BY COLLECTIONS

KEY

- Unavailable
- Available
- Available in some versions (see price list)

	ASKI	BAT EXECUTIVE	BAT OFFICE	CARMA & CARMA FOLDING	GORKA	HANNA	GUNE	OSTOA	TKNIKA	TOPA	USOA	ZUBI
STRAIGHT EDGE	•	◦	◦	◦	◦	◦	◦	•	•	◦	◦	◦
STRAIGHT EDGE + BLACK BODY	•	-	-	•	•	-	•	•	•	•	-	-
ROUNDED EDGE	-	-	-	-	-	-	•	•	-	•	-	-
BEVELLED EDGE	•	-	-	-	-	-	-	-	-	-	-	-

· Straight edges:  
Melamine, wood and black Fenix

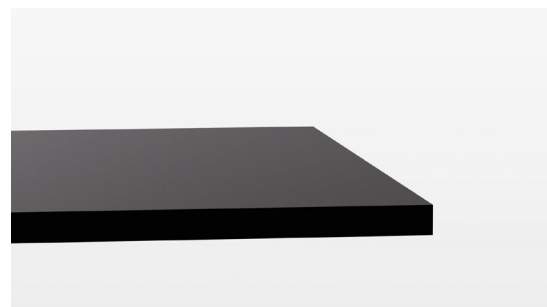
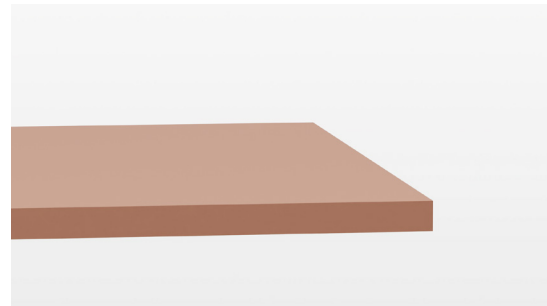

· Straight edges, black body:  
Compact

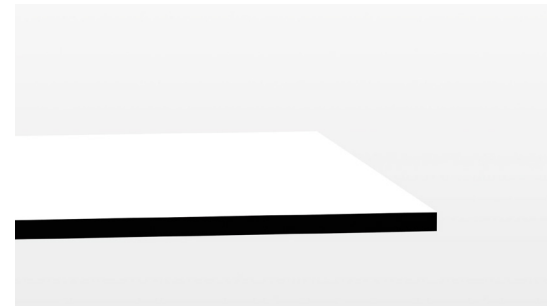

· Rounded edges:  
Laminated + plywood

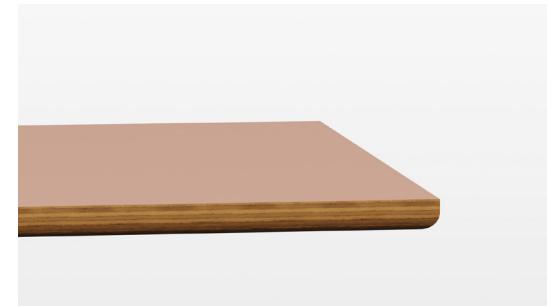

· Bevelled edges:  
Laminated + plywood

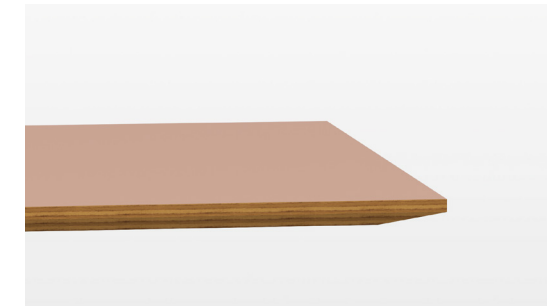

# TABLE TOP MATRIX BY COLLECTIONS

KEY

- Unavailable
- Available
- Available in some versions (see price list)

COMPACT FINISH	ASKI	BAT EXECUTIVE	BAT OFFICE	CARMA & CARMA FOLDING	GORKA	HANNA	GUNE	OSTOA	TKNIKA	TOPA	USOA	ZUBI
BLACK M-629	•	-	-	•	•	-	•	•	•	•	-	-
WHITE M-626	•	-	-	•	•	-	•	•	•	•	-	-

## LAMINATED + PLYWOOD FINISH

WHITE M-817E*	•	-	-	-	-	-	•	•	-	•	-	-
ROSE M-821E*	•	-	-	-	-	-	•	•	-	•	-	-
RED CLAY M-824E*	•	-	-	-	-	-	•	•	-	•	-	-
GREY CLAY M-823E*	•	-	-	-	-	-	•	•	-	•	-	-
OLIVE GREEN M-822E*	•	-	-	-	-	-	•	•	-	•	-	-
GRAPHITE M-818E*	•	-	-	-	-	-	•	•	-	•	-	-
OAK AURORA M-814E*	•	-	-	-	-	-	•	•	-	•	-	-
WALNUT SLOW M-819E*	•	-	-	-	-	-	•	•	-	•	-	-
OAK SINATRA M-820E*	•	-	-	-	-	-	•	•	-	•	-	-
OAK AZABACHE M-816E*	•	-	-	-	-	-	•	•	-	•	-	-

## FENIX FINISH

BLACK F-100	•	-	-	-	-	-	-	•	•	-	-	-
-------------	---	---	---	---	---	---	---	---	---	---	---	---

WOOD FINISH	ASKI	BAT EXECUTIVE	BAT OFFICE	CARMA & CARMA FOLDING	GORKA	HANNA	GUNE	OSTOA	TKNIKA	TOPA	USOA	ZUBI
OAK M-687	•	•	-	•	-	•	•	•	•	•	•	•
OAK BLACK M-686	•	•	-	•	-	•	•	•	•	•	•	•
OAK WHITE M-690	•	•	-	•	-	•	•	•	•	•	•	•
WALNUT M-688	•	•	-	•	-	•	•	•	•	•	•	•

## MELAMINE FINISH

WHITE M-817	•	-	•	•	•	•	•	•	•	•	•	•
ROSE M-821	•	-	•	•	•	•	•	•	•	•	•	•
RED CLAY M-824	•	-	•	•	•	•	•	•	•	•	•	•
GREY CLAY M-823	•	-	•	•	•	•	•	•	•	•	•	•
OLIVE GREEN M-822	•	-	•	•	•	•	•	•	•	•	•	•
GRAPHITE M-818	•	-	•	•	•	•	•	•	•	•	•	•
OAK AURORA M-814	•	-	•	•	•	•	•	•	•	•	•	•
WALNUT SLOW M-819	•	-	•	•	•	•	•	•	•	•	•	•
OAK SINATRA M-820	•	-	•	•	•	•	•	•	•	•	•	•
OAK AZABACHE M-816	•	-	•	•	•	•	•	•	•	•	•	•

S

WOOD SHELLS



# WOOD SHELL SAMPLES

Warning: the colors and/or shades of the finishes displayed on screen are to be taken as reference, as they might vary from the physical samples. In case of doubt, request our physical samples before placing an order.

## *Aia*



M-670 NATURAL OAK

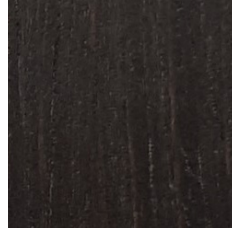

M-675 STAINED OAK  
(FLORENCE WALNUT)

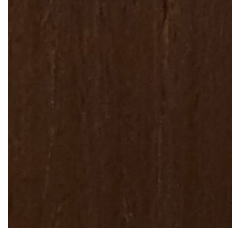

M-676 STAINED OAK  
(RIVER CHERRY)

## *Hodei*

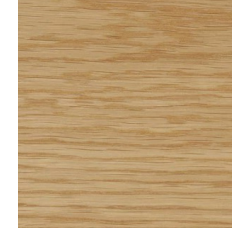

M-670 NATURAL OAK

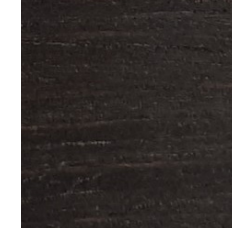

M-675 STAINED OAK  
(FLORENCE WALNUT)

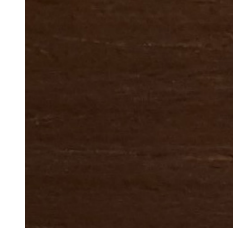

M-676 STAINED OAK  
(RIVER CHERRY)

## *Branka*



M-613 NATURAL BEECH

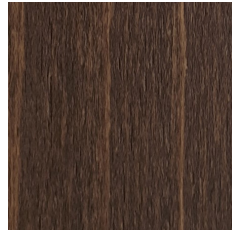

M-653 STAINED BEECH  
(WALNUT)

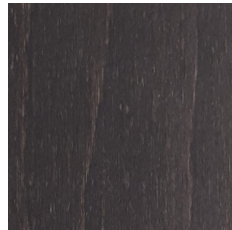

M-638 STAINED BEECH  
(WENGE)

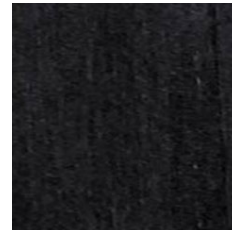

M-637 STAINED BEECH  
(BLACK)

## *Klasik*



M-670 NATURAL OAK



M-685 AMERICAN WALNUT

## *Gorka*



M-613 NATURAL BEECH

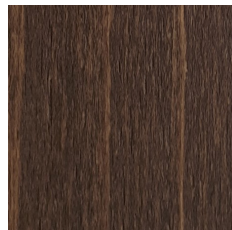

M-653 STAINED BEECH  
(WALNUT)

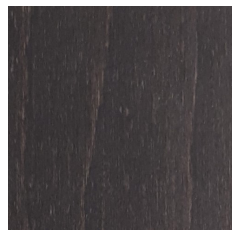

M-638 STAINED BEECH  
(WENGE)

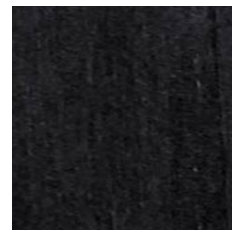

M-637 STAINED BEECH  
(BLACK)

**B**

WOODEN BASES

# WOODEN BASE SAMPLES

Warning: the colors and/or shades of the finishes displayed on screen are to be taken as reference, as they might vary from the physical samples. In case of doubt, request our physical samples before placing an order.

## *Hanna*

---



NATURAL BIRCH

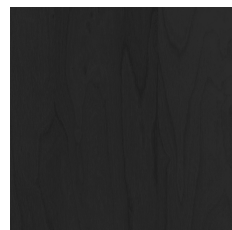

STAINED BLACK BIRCH

## *Lur*

---

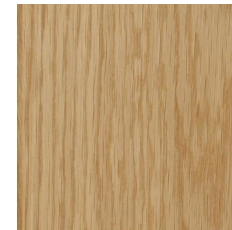

OAK

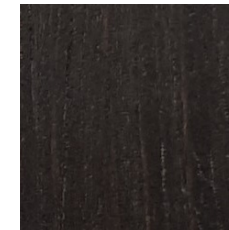

STAINED BLACK OAK (\*)

## *Kabi, Kabi Butaca & Kabi Taburete*

---



NATURAL BEECH

## *Tknika*

---



NATURAL BEECH



NATURAL OAK

## *Klasik*

---

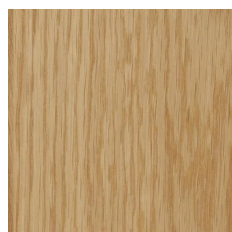

NATURAL OAK



WALNUT

## WOODEN BASE BY COLLECTION

Warning: the colors and/or shades of the finishes displayed on screen are to be taken as reference, as they might vary from the physical samples. In case of doubt, request our physical samples before placing an order.

### *Hanna*



NATURAL BIRCH



STAINED BLACK BIRCH

### *Kabi*



NATURAL BEECH



NATURAL BEECH

### *Klasik*



NATURAL OAK



WALNUT

### *Lur*



OAK



STAINED BLACK OAK (\*)



OAK

### *Tknika*



NATURAL BEECH



NATURAL OAK FINGER